

Fr | FrD | FrU

平台型繙縫機

Flat Bed Interlock Machine  
Sewing Machine



# INTERLOCK

平台型繙縫機  
Flat Bed Interlock Machine  
Sewing Machine

## FT / FTD / FTU

Series



FTD7000-0-356M/UFP-B1

### FT7069-0-356M/UFP-A3/TCS09/SE005

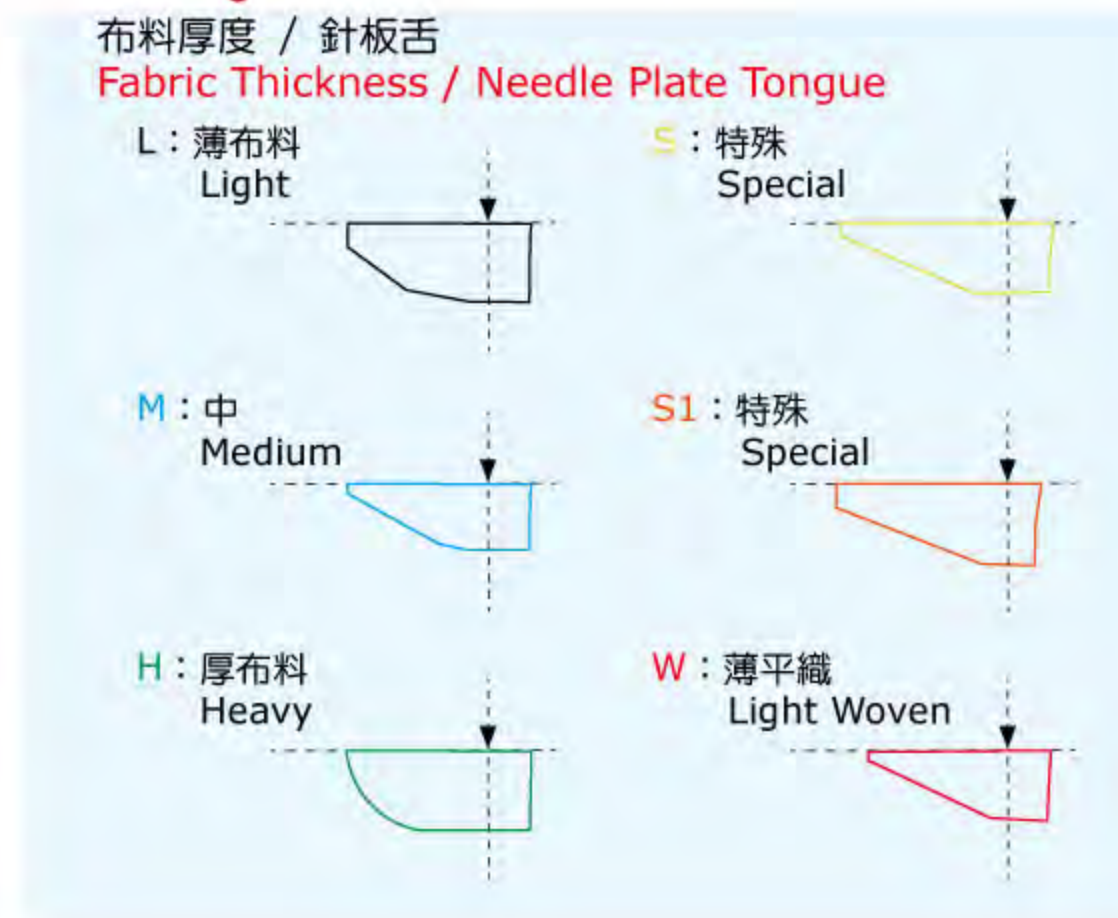

針距 /  
Needle  
Distance

針數 /  
No of Needle

	機型 / Machine Type			車縫應用 / Application Code										選配件 / Optional Device		
	直驅 Direct- Drive	上送 Top Feeding	特厚 Extra Heavy	00 一般 General	02 雙勾針 Double Looper	03 上帶 Tape Binding	08 單針鏈縫 Single Needle	10 口袋 Pocket Lining	11 下擺 Hemming	13 壓骨 Covering	15 摺線 Pin Tuck	60 四針 4-Needle Lapseam	69 右切 Right Trimmer	自動切線 Thread Trimmer	切帶 Tape Cutter	後拖輪 Rear Puller
FT70				•	•	•	•	•	•	•	•	•	•	UFP-A	TC	RP
FT72			•	•										UFE-A		
FTD70	•			•	•	•	•	•	•	•	•	•	•	UFP-B	TCS	RP
FTD72	•		•	•										UFE-B		
FTU70	•	•		•		•						•		UFP-FB		
FTU72	•	•	•	•										UFE-FB		



直驅  
Direct-Drive  
FTD/FTU



上送  
Top Feed  
FTU



送帶  
Tape Feeding &  
Metering

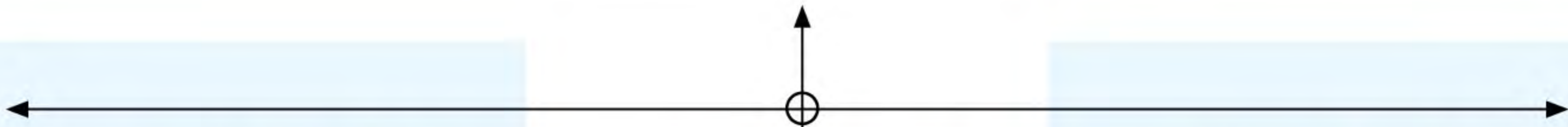

滾邊拉筒  
Tape Binder  
FT / FTD 7003



基本型  
Standard Bed  
FT/FTD/FTU



右切刀  
Right Trimmer  
FT / FTD 7069



自動切線  
Auto Thread Trimmer  
UFP / UFE



吸風切線  
Suction Thread Chain Cutter  
KI002



切帶裝置  
Tape Cutter  
TC / TCS

# 車縫應用 / SEWING APPLICATION

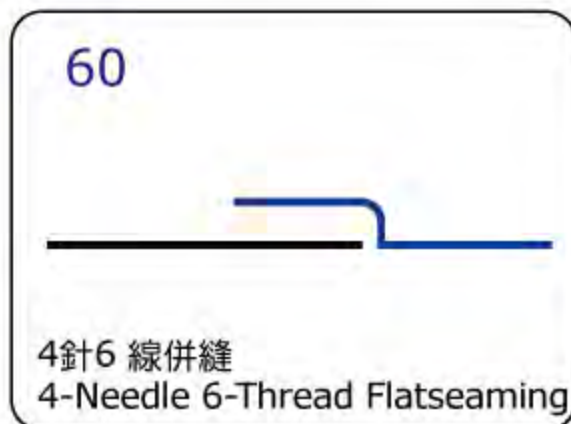
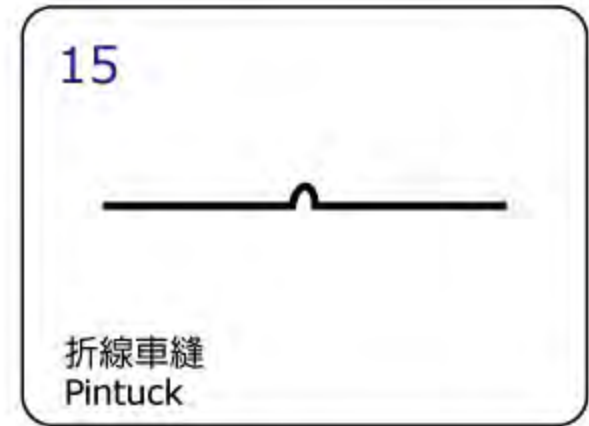
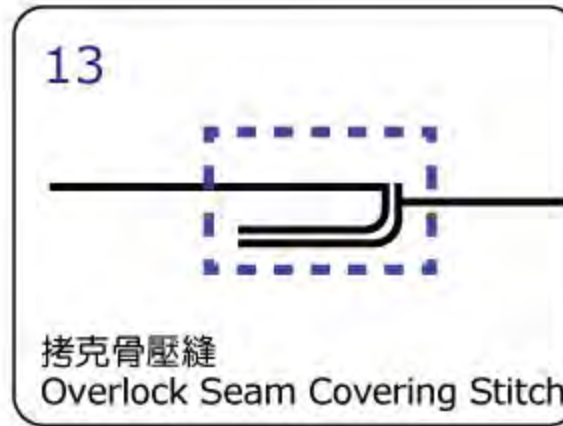
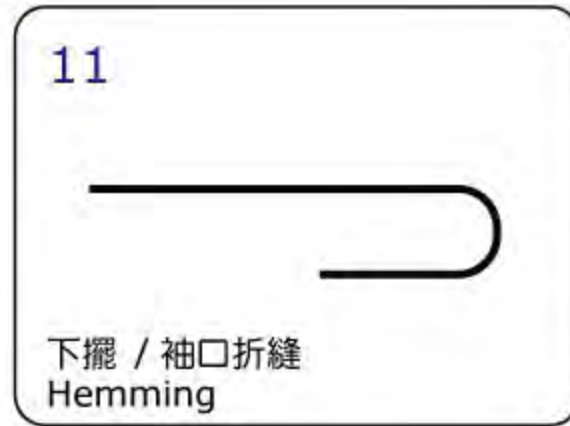
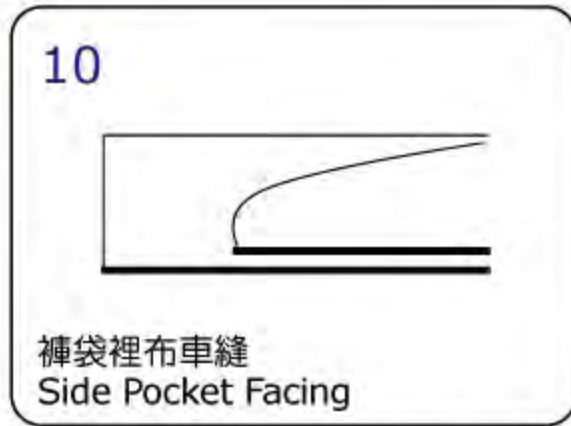

00			 m.m.	 m.m.		 m.m.			OPTIONAL DEVICE
FT 7000-0-□□□L	2	4	4.0/4.8	1.4~4.0	0.7~2.0	5	#11	6000	UFP-□ UFE-□ RP005 KI002 TB002 TB003
FTD7000-0-□□□L	3	5	4.8/5.6/6.4						
FT 7000-0-□□□M	2	4	4.0/4.8						
FTD7000-0-□□□M	3	5	4.8/5.6/6.4						
FT 7000-0-□□□H	2	4	4.0/4.8						
FTD7000-0-□□□H	3	5	4.8/5.6/6.4						
FT 7000-0-□□□W	3	5	5.6/6.4	1.4~4.5	0.7~2.0	5	#14	6000	UFP-□ UFE-□
FTD7000-0-□□□W									
FT 7200-0-□□□W	3	5	5.6/6.4						
FTD7200-0-□□□W									

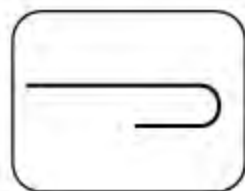







## 一般車縫 General Seaming

本機型為三針車基本規格，適用範圍含蓋薄至厚各種面料，可選配附件以進行各類車縫。

The basic model is with full specification for the all range of fabric thickness. Various devices are optional for sewing applications.

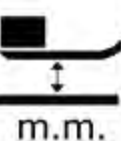
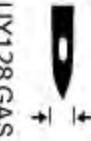

FTD7000

02			 m.m.	 m.m.		 m.m.	 UV128 GAS	 S.P.M.	OPTIONAL DEVICE
FT 7002-0-□□□M FTD7002-0-□□□M	2	4	4.8/6.4						
FT 7002-1-□□□M FTD7002-1-□□□M	3	6	6.4	1.4~4.0	0.7~2.0	5	#11	6000	TB TC TCS
FT 7002-A-□□□M FTD7002-A-□□□M	2	4	4.8						

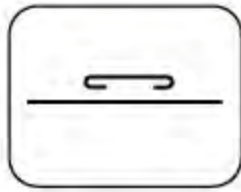





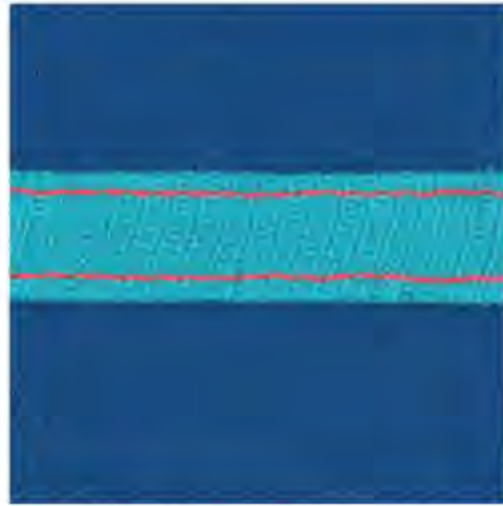

補強帶車縫  
Tape Attaching

本機型以2針4線，雙鏈縫線跡（雙勾針）來車縫布條。適用於覆蓋拷克接合處，如左右肩線與頸後圍內側之補強帶車縫。可加裝 TB 導模。

Tape attaching by 2-Needle 4-thread double chainstitch (2 loopers). Applicable to covering the overlock joint, such as the inner side of shoulder and rear neck. Tape guide device, TB, is optional.

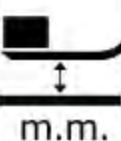

TB002

03			 m.m.	 m.m.		 m.m.	 UV128 GAS	 S.P.M.	OPTIONAL DEVICE
FT 7003-0-□□□M FTD7003-0-□□□M	2 3	4 5	3.2/4.0 4.8/5.6/6.4	1.4~4.0	0.7~2.0	5	#11	6000	TC TCS TS008
FT 7003-1-□□□M FTD7003-1-□□□M	2 3	4 5	3.2/4.0 4.8/5.6/6.4						

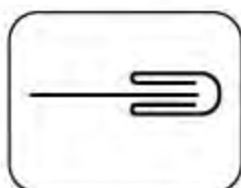

上帶滾邊車縫  
General Seaming

本機型適用於T恤領口，運動褲褲管口之滾邊車縫。03-0 為標準規格，03-1 適用轉彎。

For tape binding on the openings of T-shirt and sports short. 03-0 is standard, and 03-1 is curve specification.

導模型式  
Folder Type



2折  
Two Fold



3折  
Three Fold



4折  
Four Fold

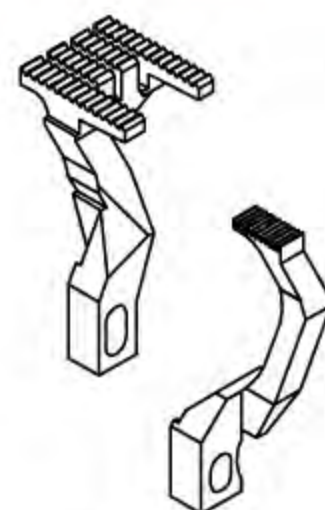

03-0  
Feed dog

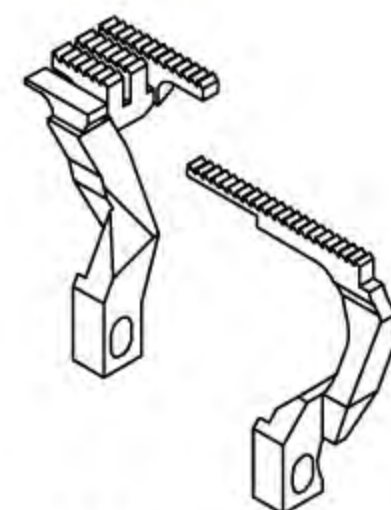

03-1  
Feed dog

08									OPTIONAL DEVICE
	FT 7008-2-0100M FTD7008-2-0100M	1	2	~	1.4~4.0	0.7~2.0	5	#11	6000



## 單針鏈縫 Single Needle Chain stitch

搭配窄壓腳，直線或轉彎車縫皆宜，適用於彈性或非彈性面料。

Equipped with narrow presser foot, which can sew both straight and curve. Wide application to both elastic or non-elastic fabric.

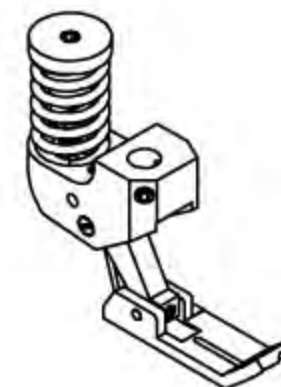

10									OPTIONAL DEVICE
	FT 7010-0-388M FTD7010-0-388M	3	7	8.8	1.4~4.0	0.7~2.0	5	#12	5500

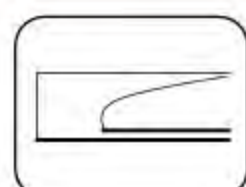

## 褲袋裡布車縫 Side Pocket Facing Attaching

本機型為3針3勾針，線跡為3 鏈縫與1 網線，適用於牛仔褲、西褲等口袋裡布車縫。

The machine is with 3 pairs of needle and looper. The stitch type is 3 double chainstitch and 1 covering thread, which is applicable to Jeans and trousers' side pocket facing.



11									OPTIONAL DEVICE
	FT 7011-0-□□□M FTD7011-0-□□□M	2 3	4 5	4.0/4.8 5.6/6.4	1.4~4.0	0.7~2.0	5	#11	6000

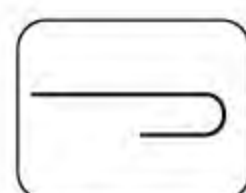







## 下擺折縫 Hemming

本機型適用於各種針織衣物之下擺折縫，附可調式導布器。

Applicable to various knit wear's hemming, equipped with adjustable hemming guide.

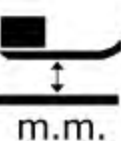

FTD7011

13			 m.m.	 m.m.		 m.m.	UY128 GAS 	S.P.M. 	OPTIONAL DEVICE
FT 7013-0-□□□M	2	4	4.0/4.8	1.4~4.0	0.7~2.0	5	#11	6000	UFP-□ UFE-□
FTD7013-0-□□□M	3	5	4.8/5.6/6.4						
FT 7013-1-□□□M	2	4	4.0/4.8						
FTD7013-1-□□□M	3	5	4.8/5.6/6.4						
FT 7013-2-□□□M	2	4	4.0/4.8						
FTD7013-2-□□□M	3	5	4.8/5.6/6.4						

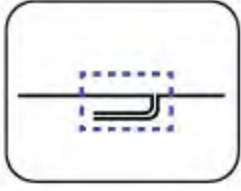

















拷克骨壓縫  
Overlock Seam  
Covering Stitch

拷克骨壓縫有倒骨式(適用4線拷克),  
與立骨式(適用3線拷克)

Overlock seam covering stitch by  
Fold type  
(4-thread overlockseam applicable)  
and Flattening type  
(3-thread overlock seam applicable)

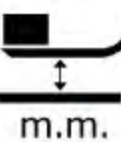

<p><b>13-0</b></p> <p>倒骨式 Fold type</p>  <p>3mm</p>		
<p><b>13-1</b></p> <p>立骨式 Flattening type</p> 		
<p><b>13-2</b></p> <p>倒骨式 Fold type</p>  <p>6mm</p>		

15			 m.m.	 m.m.		 m.m.	UY128 GAS 	S.P.M. 	OPTIONAL DEVICE
FT 7015-0-0232M	2	3	3.2	1.4~4.0	0.7~2.0	5	#11	6000	UFP-□ UFE-□
FTD7015-0-0232M									

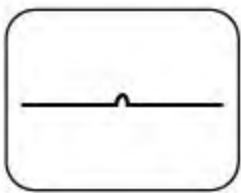





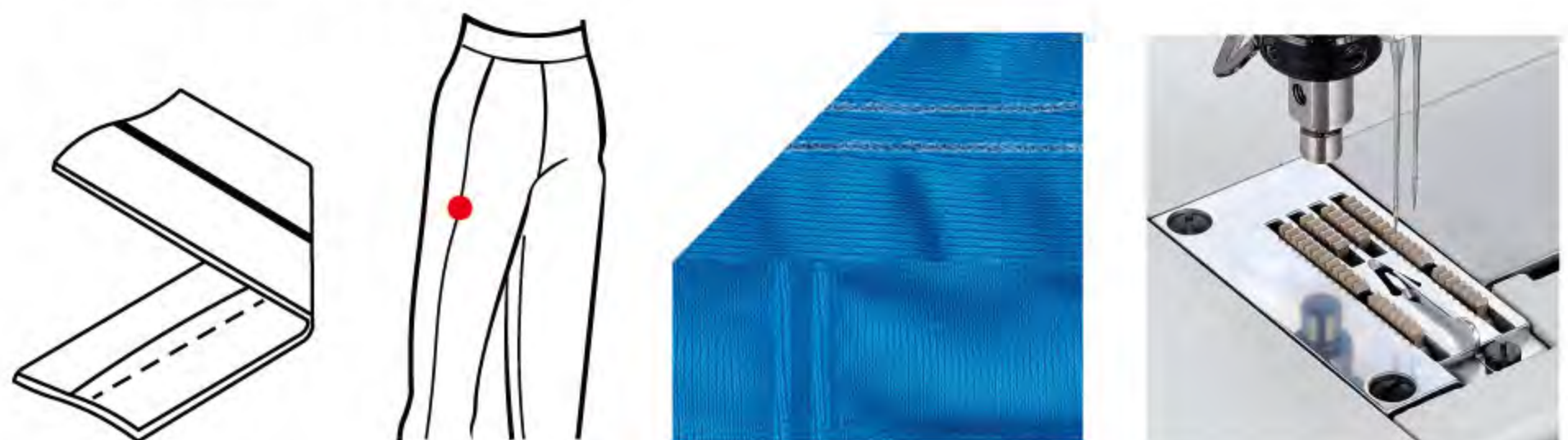

折線車縫  
Pin Tucking

適用於運動服之凸面摺線條裝飾。

Applicable to sports wear's convex stripe decoration.

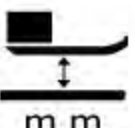

60			 m.m.	 m.m.	 m.m.	 m.m.	 MY1014 B		OPTIONAL DEVICE
FT 7060-0-4□□M FTD7060-0-4□□M	4	6	5.2/5.8 6.0/6.4	1.4~4.0	0.7~2.0	5	#11	6000	UFP-□
FT 7060-0-464H FTD7060-0-464H	4	6	6.4						#14







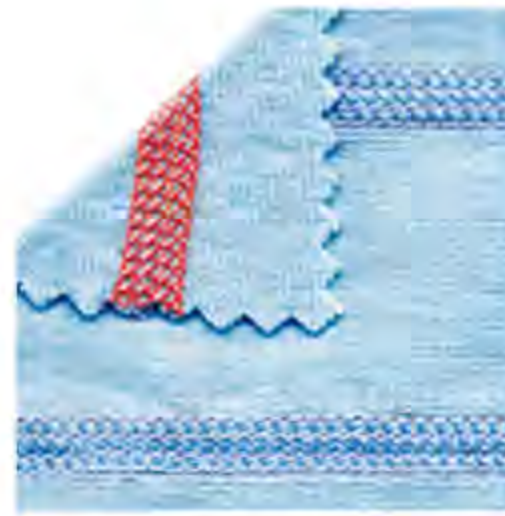

## 四針六線併縫 4-Needle 6-Thread Flatseaming

本機型為經濟型的四針六線併縫功能，若需要修剪布邊，可選用高階機型FTK 2500系列。

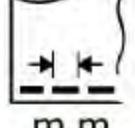
This model is with economical 4-needle 6-thread flat seaming function.  
If fabric edge trimming is necessary, the high-class model FTK 2500 series is optional.

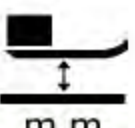

69			 m.m.	 m.m.	 m.m.	 m.m.	 UY128 GAS		OPTIONAL DEVICE
FT7069-0-□□□L	2	4	3.2/4.0	1.4~4.0	0.7~2.0	5	#11	4500	SE005
	3	5	5.6/6.4						
FT7069-0-□□□M	2	4	3.2/4.0/4.8						
	3	5	5.6/6.4						
FT7069-1-□□□M	3	5	5.6/6.4						
FT 7069-2-□□□L FTD7069-2-□□□L	2	4	3.2/4.0						
	3	5	5.6/6.4						
FT 7069-2-□□□M FTD7069-2-□□□M	2	4	3.2/4.0/4.8						
	3	5	5.6/6.4						
FT7069-3-232M FT7069-3A-232M	2	4	3.2						
	2	4	3.2						
FT 7069-4-□□□L FTD7069-4-□□□L	2	4	3.2/4.0						
	3	5	5.6/6.4						
FT 7069-4-□□□M FTD7069-4-□□□M	2	4	3.2/4.0/4.8						
	3	5	5.6/6.4						
FT 7069-5-232M FTD7069-5-232M	2	4	3.2						
	2	4	3.2						
FTD7069-6-□□□L FTD7069-6A-□□□L	2	4	3.2/4.0						
	3	5	5.6/6.4						
FTD7069-6-□□□M FTD7069-6A-□□□M	2	4	3.2/4.0/4.8						
	3	5	5.6/6.4						
FTD7069-7-232M FTD7069-7A-232M	2	4	3.2						
	2	4	3.2						

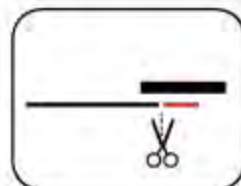

## 右切刀/ 上鬆緊帶/ 細滾邊 Right Edge Trimming/ Elastic Tape Attaching/ Fine Tape Binding

本機型配備右切刀，可先將布料邊緣修齊，再與鬆緊帶或蕾絲車縫。  
有兩種車縫樣式：鬆緊帶上帶 / 細滾邊。

The machine is equipped with right edge trimmer, which can trim the fabric edge to align the tape. Two sewing types: Tape attaching / Fine tape binding.



FTD7069-6



機型 Model	右切刀 Right Edge Trimmer	小喇叭 Small Tape Binder	送帶裝置 Tape Metering Feeding	
FT	7069-0	●	連桿式 Rod type	
	7069-1		連桿式 Rod type	
	7069-2	●		
	7069-3	●	●	連桿式 Rod type
	7069-3A	●	●	
FT FTD	7069-4	●	齒輪變速機 Gearbox	
	7069-5	●	●	齒輪變速機 Gearbox
FTD	7069-6	●	電子式 Electrical type	
	7069-6A	●	電子式+面板 Electrical type + Panel	
	7069-7	●	●	電子式 Electrical type
	7069-7A	●	●	電子式+面板 Electrical type + Panel



連桿式 / Rod type



齒輪變速機 / Gearbox

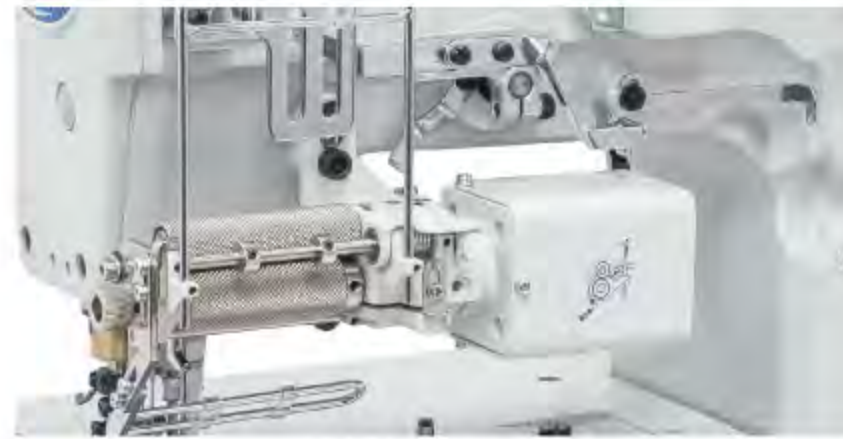

電子式+面板 / Electrical type + Panel



FT / FTD7069 -0, -2, -4, -6

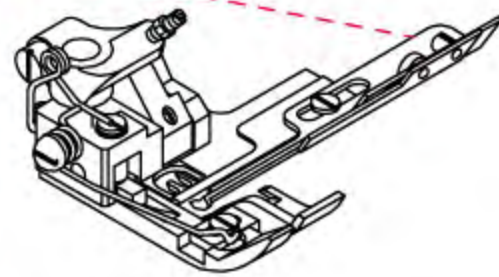

上送帶 / 鬆緊帶車縫  
Top feeding tape / Elastic tape Attachin



最大寬度/ Max. Tape Width  
蕾絲帶/ Lace tape : 80mm  
鬆緊帶/ Elastic tape: 25m



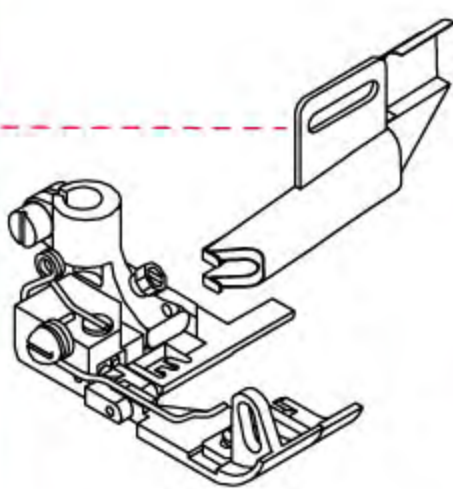





FT / FTD7069 -3, -5, -7



上送帶 / 鬆緊帶車縫  
Top feeding tape / Elastic tape Attachin

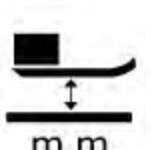

入帶寬度/ Tape width:  
16mm, 15mm, 18mm

U			 m.m.	 m.m.			 m.m.	UY 128 GAS 	S.P.M. 	OPTIONAL DEVICE
FTU7003-0-□□□M	3	5	4.8/5.6/6.4	1.4~4.0	0.7~2.0	1~6	5		5500	TC
FTU7003-0-356S	3	5	5.6							
FTU7011-0-□□□L	2	4	4.0/4.8							
	3	5	4.8/5.6/6.4							
FTU7011-0-□□□M	2	4	4.0/4.8							
	3	5	4.8/5.6/6.4							
FTU7011-0-□□□M/EG030	2	4	4.8							
	3	5	5.6/6.4							
FTU7011-0-□□□H	2	4	4.0/4.8							
	3	5	4.8/5.6/6.4							
FTU7011-0-□□□W	3	5	5.6/6.4							
FTU7060-0-460M	4	6	6.0							
FTU7200-0-3□□M	3	5	6.0					MY1014B #11	5000	

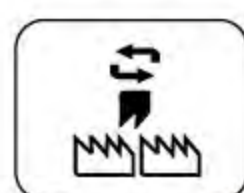

## 上送機型 Top Feed Models



FTU7003



FTU7011



## FTU7011/EG030

半自動下擺 / 袖口折縫

Semi-Auto Sleeve Hemming

配備氣動式導布器與電眼，人員只需上料，即可由機器自動車縫。

Equipped with the pneumatic fabric guide and edge sensors, after loading the fabric, and then the machine sews automatically.



折邊寬度 / Hemming Width:  
15~30 mm



FTU7011 / EG030



## 自動切線組 Auto Thread Trimmer Set

<b>UFE - A1</b> ① ② ③ ④	① 自動切線裝置代號 Under bed thread trimmer device
	② 機型 C:方筒型繡縫機 F:平台型繡縫機 Model C:Cylinder bed F:Flat bed
	③ 動力 P:氣動式 E:電動式 Power P:Pneumatic Type E:Electric Type
	④ 裝置組合代號 Combination of devices

# UFP-□□ UFE-□□



## 電動式切線組 Elastic Type Thread Trimmer

UFE -□□	下切 Under Trimmer	上切 Top Trimmer	撥線 Wiper (WPH)	抬壓腳 Presser Foot Lifter	適用機型 Application
A1	UTE02	STE		✓	FT7000
A2			✓		
A3		STE	✓*		
A4					
B1	UTE07	STE03		✓	FTD7000
B2			✓		
B3		STE03	✓*		
B4					
FB1 FB4	UTE07F	STC04		PFE2F	FTU7000

\* 包裝於附件箱中/ Packed in the accessories box

## 氣動式切線組 Pneumatic Type Thread Trimmer

UFP -□□	下切 Under Trimmer	上切 Top Trimmer	撥線 Wiper (WPC)	抬壓腳 Presser Foot Lifter	氣閥 Valve	適用機型 Application
A1	UTD02	STD		✓	2	FT7000
A2			✓			
A3		STD	✓*			
A4						
AA	UTD04			✓	2	FT7060
B1	UTD07	STD03		✓	2	FTD7000
B2			✓			
B3		STD03	✓*			
B4						
BA	UTD07B	STD03		✓	2	FTD7060
FB1	UTD07F	STB04		✓	2	FTU7000
FB2			WPC03			
FB3		STB04	WPC03*			
FB4						

\* 包裝於附件箱中/ Packed in the accessories box

\*\* 氣動UT組尾碼, 無: SMC, C:氣立

空壓需求 Compressed Air	氣壓 Air Pressure (kgf/cm <sup>2</sup> )	消耗量 * Consumption (liter/ min)
UFP (Thread Trimming Only)	4~5	10
UFP + Device (FTD7069/CV, FTD7000/KI)	5~6	40



\* 經驗值供參考

\* Empirical value for reference



氣壓式壓腳穩壓裝置  
Pneumatic Presser Foot  
Pressure Regulator

## AL015

具精密調壓閥，壓腳的壓力數字化設定，當車縫中面料厚度改變時，壓力控制穩定。

With the air pressure valve, the pressure value is done by digital setting. When sewing across the material thickness changing, the pressure keeps constant.



下吸式 吸風切線  
Under-bed Suction Chain Cutter

## KI002

搭配吸風馬達或空壓設備，將線環吸入切刀槽內切斷。特殊設計的針板，與切刀組互相嵌入，車縫完畢時，線環隨即被吸入切刀口，操作順手效率高，並大幅節省用線量。

With suction motor or air compressor, the thread chain is sucked into the cutter slot and cut off. The specially designed needle plate is embedded with the cutter set. When the sewing is finished, the thread chain is sucked into the cutter immediately, which is easy to operate and highly efficient, and greatly saves thread consumption.

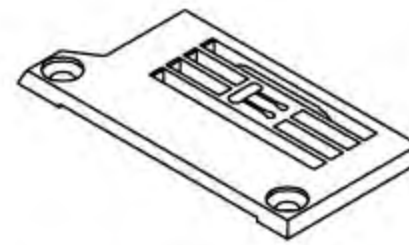

針距 Distance of Needles	針板 Needle Plate
FT7000 (5.6)	5222TP00569
FT7000 (6.4)	5222TP00647
FT7010 (8.8)	5221TP10881
FT7060 (5.2)	5228TP60524
FT7060 (5.6)	5228TP60564
FT7060 (6.0)	5228TP60604
FT7060 (6.4)	5228TP60644
FT7002 (4.8)	5221TP2481
FT7002-A (4.8)	

反射式電眼  
Reflective type Sensor for Fabric Edge

## SE

具有多種支架，對應各種車縫情況所需要的感應位置。

The various bracket sets for the various positions of the different sewing applications.

SE005 (FTD7069)  
SE006 (FTD7000)



補強帶導模  
Tape Binder

# TB

TB002 上送帶導布器  
Top loading tape binde

TB003 褲耳車縫  
Belt loop sewing



TB002



TB003

切帶裝置  
Tape Cutting Device

<h1>TC</h1> <h1>TCS</h1>	組件代號 Item Code	切斷寬度 Cutting Width	刀口/壓腳 間距 Blade to Presser foot	驅動方式 Actuation	適用針板 Needle Plate	適用機型 Application
	TC001 TC004 TCS01 TCS04	32 mm	31.9 mm	氣動 Pneumatic	標準針板 Standard needle plate	TC001/ TCS01 : FT/FTD/FTU7003  TC004/ TCS04 : FT/FTD7069
	TC002 TC005 TCS02 TCS05	32 mm	31.9 mm	電動 Electric	標準針板 Standard needle plate	TC002/ TCS02 : FT/FTD/FTU7003  TC005/ TCS05 : FT/FTD7069
	TC003 TCS003	28 mm	5.3 mm	氣動 Pneumatic		FT/FTD/FTU7003 (356, 364)
	TC008 TCS008	28 mm	11 mm	氣動 Pneumatic		FT/FTD7002
	TC009 TC019 TCS09 TCS19	28 mm	12.3mm	氣動 Pneumatic	7003  7069	TC009/ TCS09: FT/FTD/FTU7003 FT/FTD7069-0, -2, -4, -6  TC019/ TCS19: FT/FTD7069-3, -3, -7
	TCS33	28 mm	25 mm	氣動 Pneumatic	標準針板 Standard needle plate	FT/FTD 7000  上掛式活動刀組，車縫空間 淨空無阻礙 Top mounted type moving knife makes sewing area free without obstacal.

TCS 系列由伺服馬達控制 / TCS series is controlled by servo motor controller  
TC 系列有專用電控箱 / TC series is equipped with the independent controller

## 滾條架 Tape Stand

TS	說明 Description	適用機型 Applicable
TS003	上送帶 Top feeding	FTD7002, FTD7069
TS005	側送帶 Side feeding	FTD7003
TS008	側送帶 (附導柱) Top feeding	FTD7003
TS010	下送帶附導布器 Bottom feeding with tape folder	FTD7003



## 送帶裝置 Tape Feeding Device

### TF□

以在鬆緊帶或針織布帶進入張力控制裝置之前，確保其為無張力狀態，有上送型 TFU 與側送型 TFS 可供選擇，最大適用寬度 70 mm。

Ensure that the tap (elastic or knitted fabric) is tension-free before it enters the tension control device. TFU is top-feeding type and TFS is side-feeding type for optional. Applicable tape width is up to 70 mm.

TF□	適用機型 Applicable Models
TFU	UH9004-243E, UH9083, UH9084, UH9094, FT7069, FT7002
TFS	UH9055, UH9075, FT7003, CT9003



TFU



TFS



**精機機械廠股份有限公司**  
**CHING CHI MACHINE CO., LTD**  
<http://www.kingtexsewing.com.tw>

公司:新北市板橋區三民路2段33號13F

電話:(02)2961-6865 FAX:(02)2954-6007

OFFICE:13F., NO.33, Sec2, San Min Rd.Panchiao Dist.,  
New Taipei City, 22069 Taiwan

TEL:(02)2961-6865(REP)

FAX:(02)2954-6007

E-Mail:Kingtexas@kingtexas.com.tw

