

MT | MTD

筒型多針鏈縫機

Cylinder Bed Multi-needle Chainstitch Sewing Machine



Multi-Needle

筒型多針雙鏈縫紉機
Cylinder Bed Multi-Needle
Chainstitch Machine



MT4512P-064

MT / MTD Series

MT4506P□-064□/TB004

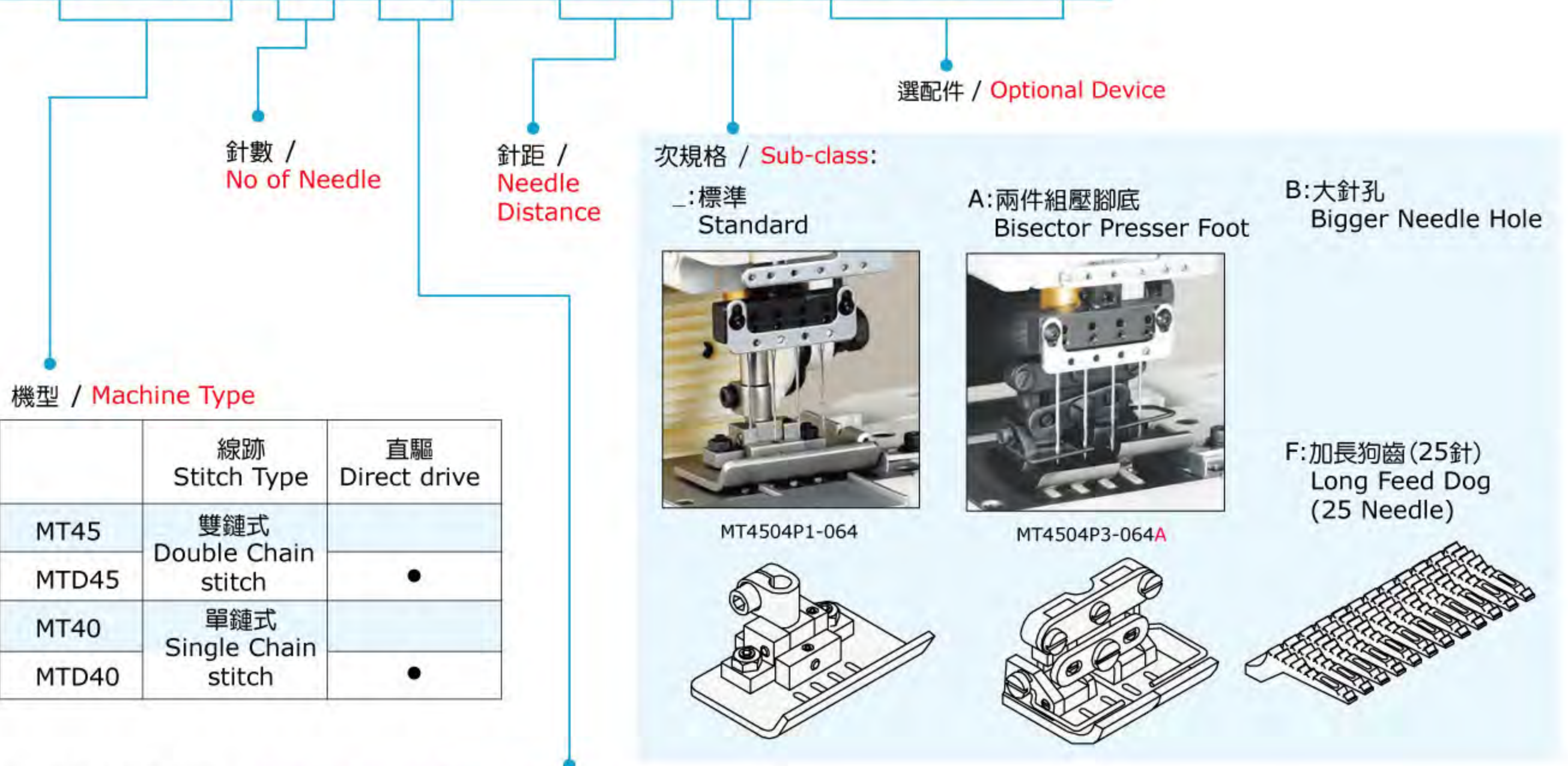



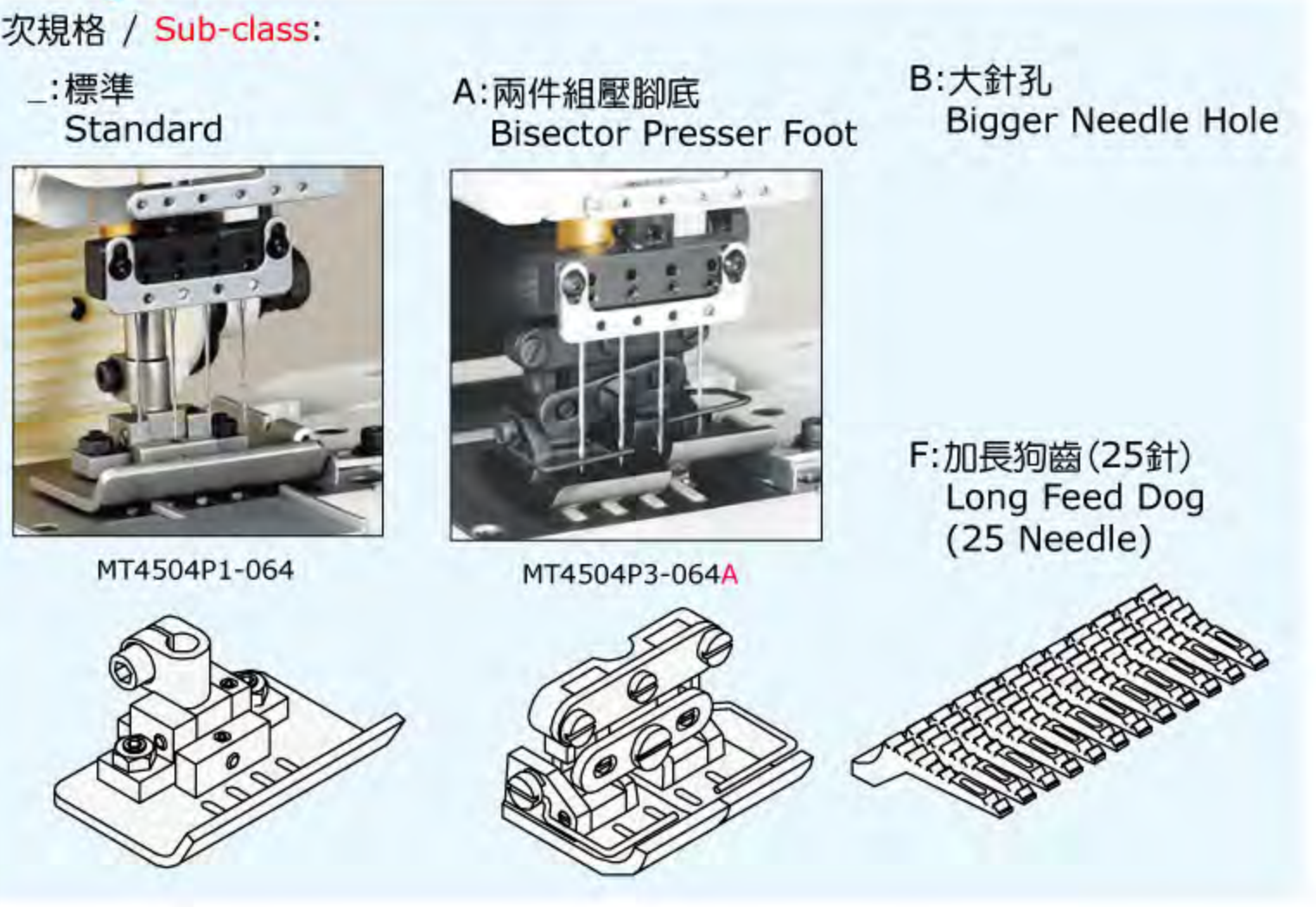



	線跡 Stitch Type	直驅 Direct drive
MT45	雙鏈式 Double Chain stitch	
MTD45		●
MT40	單鏈式 Single Chain stitch	
MTD40		●



後拉輪：形式與齒數 / Puller: Type & Teeth number

滾輪 Rollers	P	P0	P1	P2	P3
上輪 Upper	28	平輪 Flat type	18	22	鐵輪 Grooved Steel
下輪 Lower	15	平輪 Flat type	10	12	鐵輪 Grooved Steel
P□					

General				 m.m.	 m.m.	 U0113	 S.P.M.	OPTIONAL DEVICE
MT4504P-□□□	4	8	詳標準針位 Please refer to the standard gauge	1.4~3.6	12	#11 ? #14	4000	AL004 PMD
MT4506P-□□□	6	12						
MT4509P-□□□	9	18						
MT4512P-□□□	12	24						
* MT4513P-□□□	13	24						
* MT4517P-□□□	17	24						
* MT4523P-□□□	23	24						
* MT4525P-□□□	25	24						





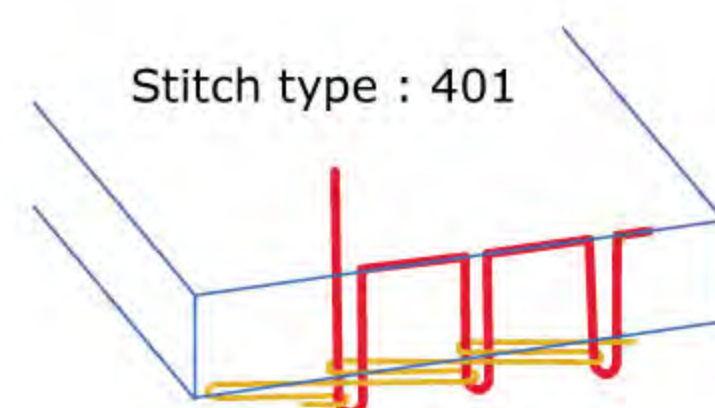

* 搭配12針規格的控線組
The below models are equipped with 12-needle spec. thread controller.

一般車縫 / 雙鏈式環縫 General Seaming / Double Chain Stitch

本機型為多針雙鏈式環縫基本型，以面線（針線）與底線（勾針線）結合成為線跡，可選配附件以進行多種樣式車縫。

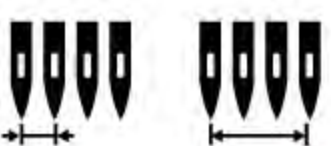
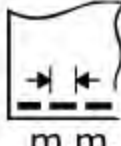
The basic model of multi-needle double chainstitch machine. The stitch is composed with upper thread(needle) and lower thread (Looper). Various devices are optional for sewing applications.



General				 m.m.	 m.m.	 UO113	 S.P.M.	OPTIONAL DEVICE
MT4004P-□□□	4	4	詳標準針位 Please refer to the standard gauge	1.4~3.6	12	#11 ? #14	6000	AL004 PMD
MT4006P-□□□	6	6						
MT4009P-□□□	9	9						
MT4012P-□□□	12	12						

一般車縫 / 單鏈式環縫
General Seaming / Single Chain Stitch

本機型為多針單鏈式環縫車基本型，以單線由針帶動形成線環，無底線（結線勾不穿線），可選用彈性線以形成抽皺效果，有多種選配附件以進行多種樣式車縫。

The basic model of multi-needle single chain stitch machine. The stitch is formed of one thread (needle thread) without lower thread (no threading on the looper). Elastic thread is applicable. Various devices are optional for sewing applications.

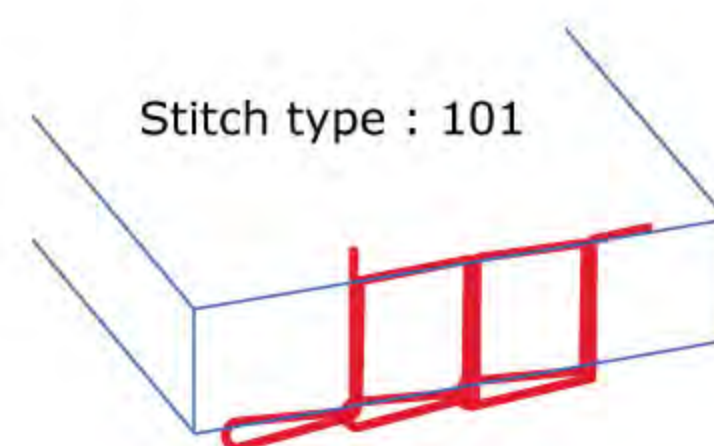







MT4004P



MT4006P

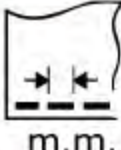

MT4012P

PMD				 m.m.	 m.m.	 UO113	 S.P.M.	OPTIONAL DEVICE
MT4504P-□□□/PMD	4	8	詳標準針位 Please refer to the standard gauge	1.4~3.6	12	#11 ∩ #14	3500	
MT4506P-□□□/PMD	6	12						
MT4512P-□□□/PMD	12	24						
MT4513P-□□□/PMD	13	24						
MT4517P-□□□/PMD	17	24						
MT4523P-□□□/PMD	23	24						







褲頭鬆緊帶車縫 Elastic Band Attaching

本機型適用於短褲，運動短褲之褲腰鬆緊帶車縫。
For Elastic waistband attaching on boxer and sports shorts.

	滾輪型式 Roller Type	適用 Applicatio
PMD01	壓花滾輪 Knurl roller	鬆緊帶 Elastic Band
PMD02	平輪 Knurl roller	橡筋線抽皺 Elastic Thread Shirring

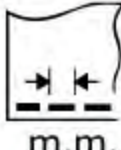

MT4504P0-064/PMD







PS				 m.m.	 m.m.	 UO113	 S.P.M.	OPTIONAL DEVICE
MT4512P-064/PS01A	12	24	1/4(6.4mm)	1.4~3.6	12	#11 ∩ #14	3500	TS009 PMD02
MT4512P-048/PS01B	12	24	3/16(4.8mm)					

鬆緊線抽皺 Elastic Thread Shirring

底線為彈性橡筋線，以壓腳底的段差，配合PMD02控制底線張力，產生皺摺樣式。

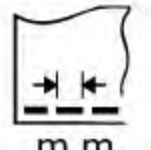
The looper thread is elastic. With the presser foot's step difference and PMD02 tension control, it makes shirring pattern.







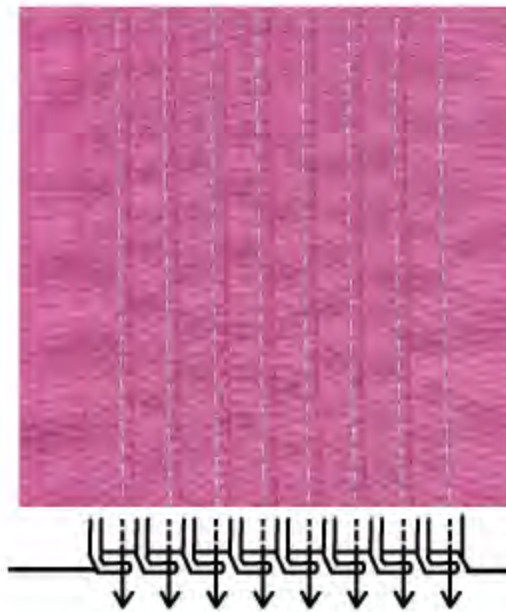

PT				 m.m.	 m.m.	 UO113	 S.P.M.	OPTIONAL DEVICE
MT4512P0-064/PT001	12	24	1/4(6.4mm)	1.4~3.6	12	#11 ? #14	2000	AL004
MT4512P0-048/PT001	12	24	3/16(4.8mm)					

摺布車縫
Pin Tucking

配備專用導布器，適用於摺布裝飾縫。
Equipped with the special fabric folder for pin-tucking decorative seam.



MT4512-064/PT001

PSM/PSSM				 m.m.	 m.m.	 DV57	 S.P.M.	OPTIONAL DEVICE
MT4512P0-064 /PSM /PSSM	12	24	1/4(6.4mm)	1.4~3.6	12	#14 ? #18	1500	
MT4516P0-048 /PSM /PSSM	16	32	3/16(4.8mm)					
MT4525P0-064 /PSM /PSSM	25	50	1/4(6.4mm)					
MT4533P0-048 /PSM /PSSM	33	66	3/16(4.8mm)					
MT4525P0-038 /PSM /PSSM	38	76	1/4(6.4mm)					
MT4533P0-050 /PSM /PSSM	50	100	3/16(4.8mm)					

打纜裝飾縫
Smocking

具有40種凸輪，可供打纜圖形變換。
PSM的底線為一般線。
PSSM的底線為橡筋線，有抽褶效果。

Equipped with 40 cams to change the smocking pattern. PSM's looper thread is normal. PSSM's looper thread is elastic, which makes shirring style.

	針 Needle	勾針 Looper	下送線滾輪 Lower Thread Tension Roller
PSM	一般線 Normal Thread	一般線 Normal Thread	X
PSSM	一般線 Normal Thread	橡筋線 Elastic Thread	✓

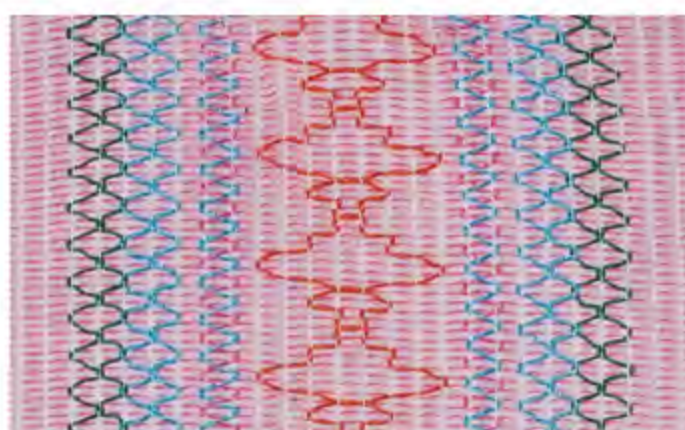







MT45380-064/PSSM

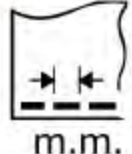

MT45380-064/PSM

車縫應用 / SEWING APPLICATION

TB				 m.m.	 m.m.	 UO113	 S.P.M.	OPTIONAL DEVICE
MT4512P0-064/TB004	12→6	12	1/4(6.4mm)	1.4~3.6	12	#11 ? #14	3500	
MT4512P0-064/TB04T/TCB41	12→6	12	1/4(6.4mm)					
MT4512P0-048/TB004	12→6	12	3/16(4.8mm)					
MT4512P0-048/TB04T/TCB41	12→6	12	3/16(4.8mm)					
MT4506P0-064-119/TB004	6	12	6.4-11.9-6.4-11.9-6.4					
MT4506P0-064-119/TB04T/TCB41	6	12	6.4-11.9-6.4-11.9-6.4					

三條線 / 貼帶車縫 3-Stripe/ Tape Attaching

本機型可車縫三貼條樣式。
可加裝TCB41 氣動式後切刀組，提高工作效率。

For 3-stripe tape attaching.
TCB41 Rear tape cutter is optional for better working efficiency.

MT4512P0-064 以12針改為6針
Modify 12-needle as 6-needle

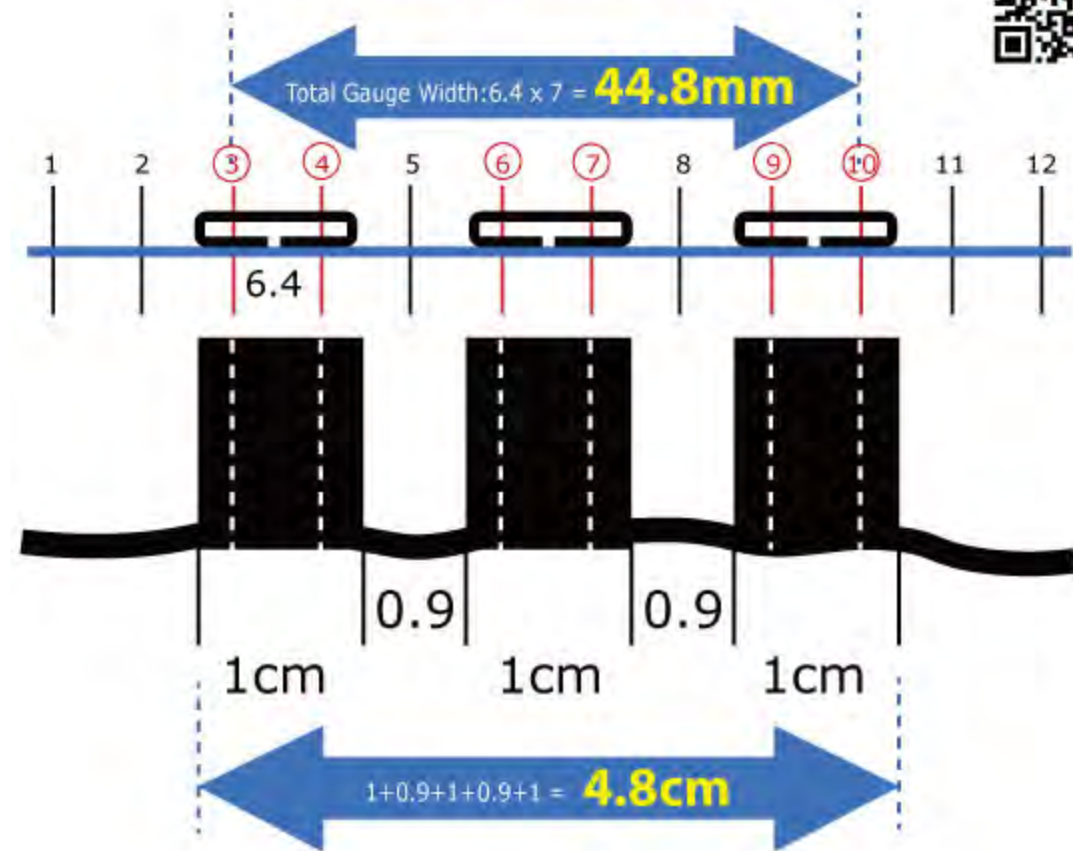

MT4512P0-064/TB004

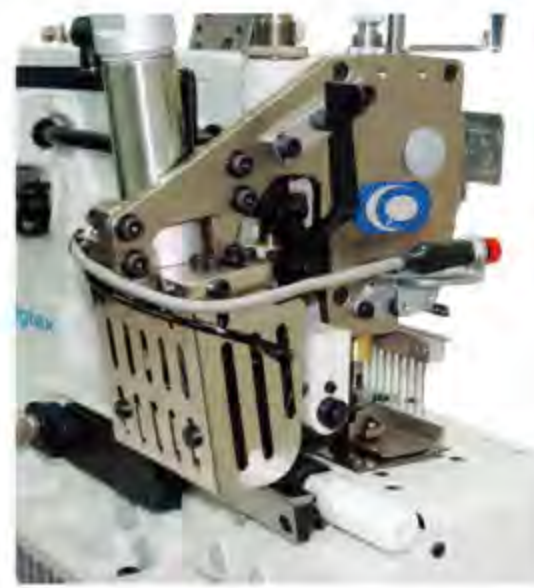

MT4512P0-048 以12針改為6針
Modify 12-needle as 6-needle

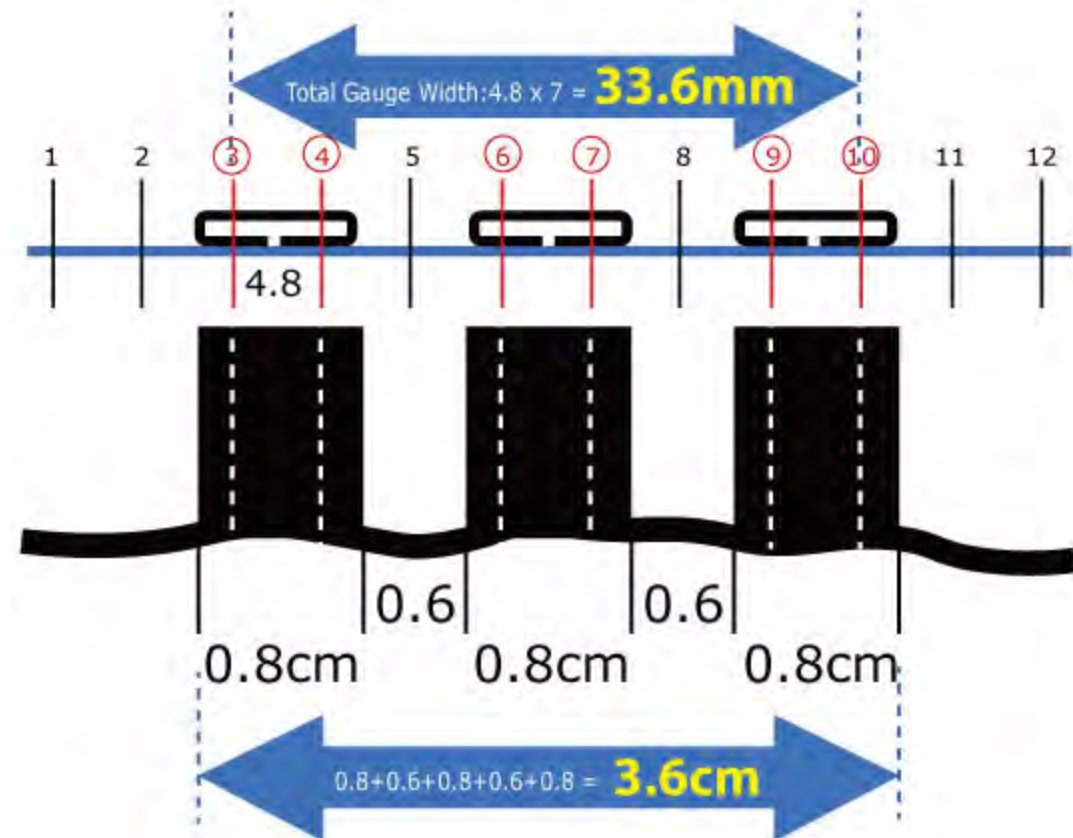

MT4506P0-064-119

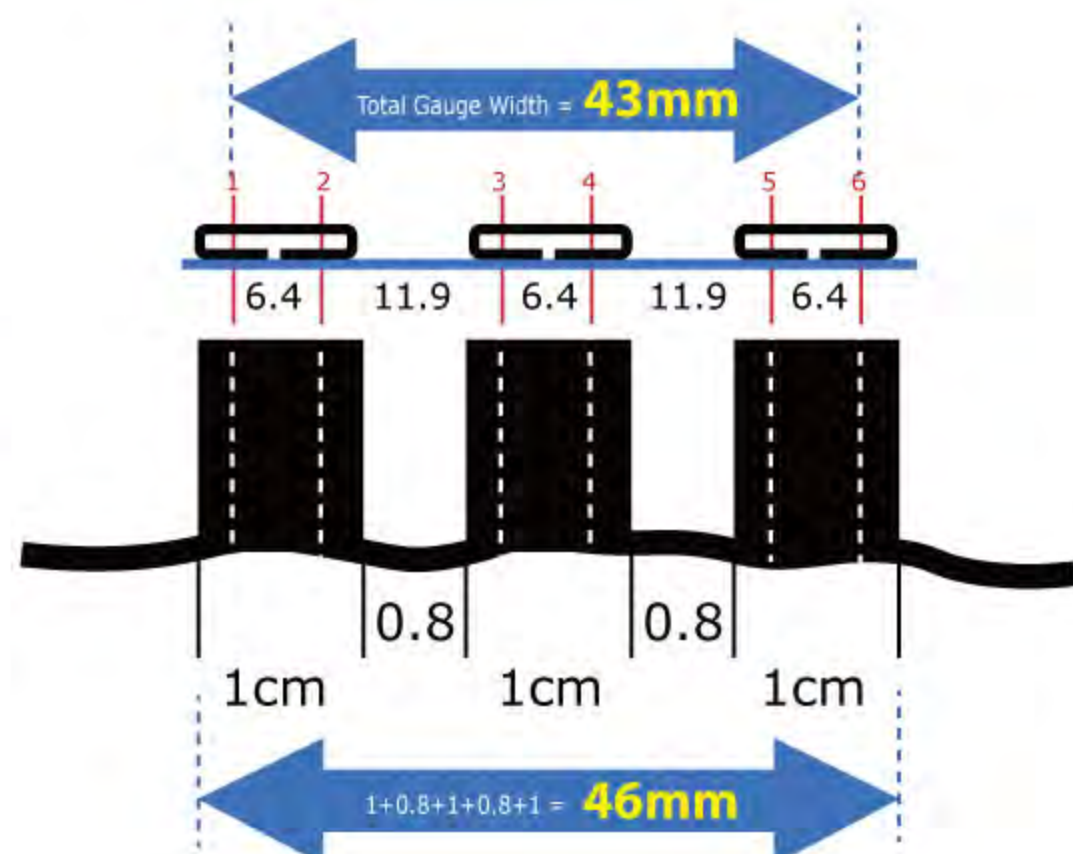



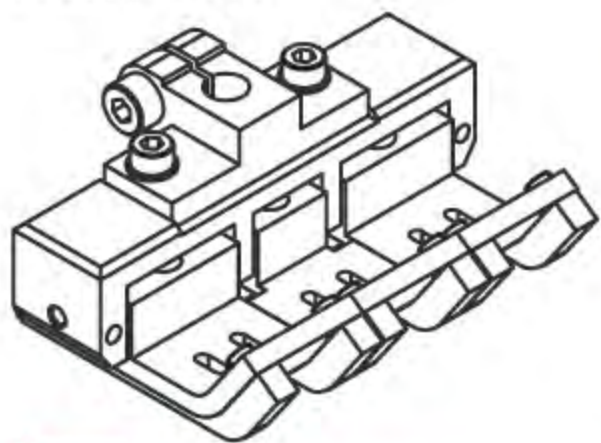



5231PF0605
特註品：三片式壓腳
Customized 3-Section
Presser Foot



Gauge:
6.4/ 12.8/ 6.4/ 12.8/ 6.4

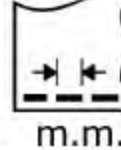

TCB41

TCS41□								OPTIONAL DEVICE
MTD4004P-□□□/TCS41□	4	4	配合鬆緊帶寬度， 詳標準針位 Please check the band width and refer to the standard gauge	1.4~3.6	12	#11 ? #14	3500	
MTD4006P-□□□/TCS41□	6	6						
MTD4504P-□□□/TCS41□	4	8						
MTD4506P-□□□/TCS41□	6	12						

褲頭鬆緊帶車縫/多功能
Elastic Band Attaching / Multi-Function



[專利] 本機型搭配瑞爾興MCA-20K，具有送帶 / 切帶 / 張力控制等多功能，適用於鬆緊帶多段張力變化之褲腰車縫。

[Patented] Equipped with Racing device MCA-20K, the machine has the functions of tape feeding, cutting, and tension control, which is applicable to multi-section tension waistband design.



MT4504P0-064/TCS41

TCS41□	鬆緊帶寬度 Elastic Band Width
TCS41A	31.8mm (1-1/4")
TCS41B	35mm (1-3/8")
TCS41C	38.1mm (1-1/2")

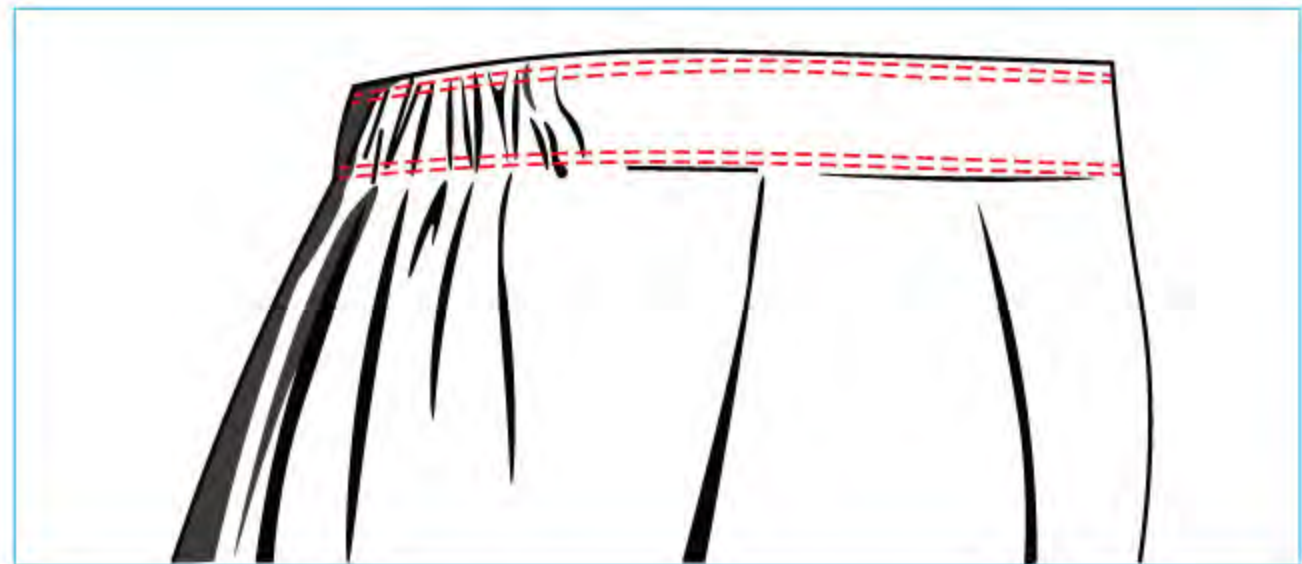

自動抬壓腳
Automatic Presser Foot Lifter

	控制方式 / Control
PFE03	電動式 Electric type
AL004	氣動式 Pneumatic type
AL004	吊桿開關 Mechanical switch valve
AL004-1	伺服馬達/氣動閥 Servo motor / solenoid valve



PFE03



AL004

選配件 / OPTIONAL DEVICE

氣動式自動切線組 Pneumatic Auto Thread Trimmer Set

UT	A	B	C	S	S1
	064(1/4)	085(1/3)	095(3/8)	032(1/8)	064-254
UT04□	●	●	●	●	●
UT04□-P		●			
UT06□	●				
UT09□	●				
UT12□	●				
UT17□				●	
UT25S, UT25S-P				* ●	

機型 / Series	針位 / Gauge	1"(25.4mm)			1"(25.4mm)			1"(25.4mm)			UT□																	
		1	2	3	4	5	6	7	8	9		10	11	12	13	14	15	16	17	18	19	20	21	22	23	24	25	
雙鏈式 Double Chain MT45 MTD45	04P-064-032																											
	04P-064																											04A
	04P-095																											04C
	04P-127																											04C
	04P-064-127																											
	04P-064-191																											
	04P-064-254																											
	06P-064																											06A
	06P-095																											
	09P-064																											09A
	12P-064																											12A
	13P-064-32																											
	17P-032																											17S
	25P-032																											25S

* UT25S 具有最大的適用彈性，可涵蓋以上14種針位
* UT25S is most flexible and covers the above 14 gauges.



UT04A:切線刀組
Thread trimmer set



UT12A:切線刀組
Thread trimmer set



UT04A 鬆線組
Thread tension release



UT12A 鬆線組
Thread tension release



LED 燈
LED Light



撥線裝置
Thread tension releaser



AL004:自動抬壓腳
Presser foot lifter



直驅伺服馬達
DD servo motor

FR 選配導模組
Optional Fabric Guide/ Binder Set

FR401

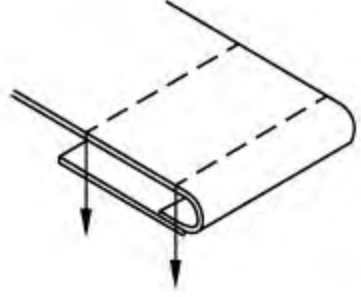

FR402

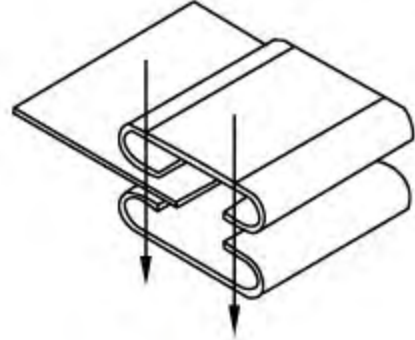
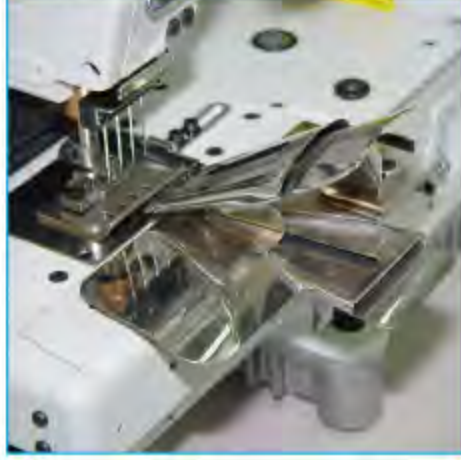

FR403

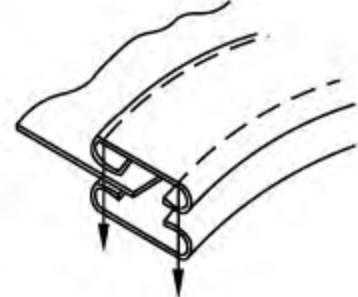

FR404

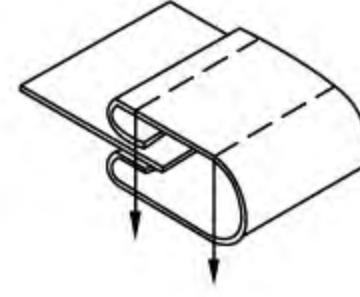

FR405

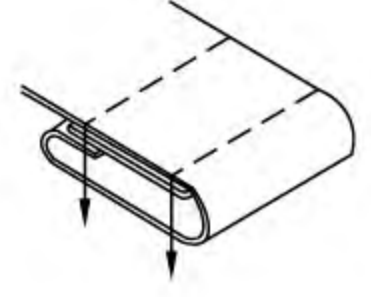

FR406 & FR407

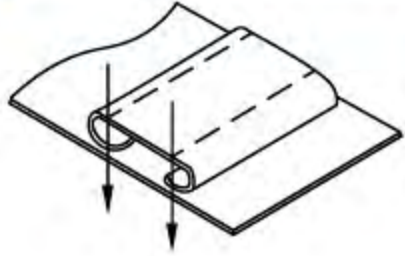

FR408

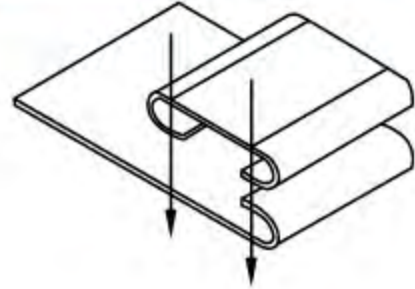



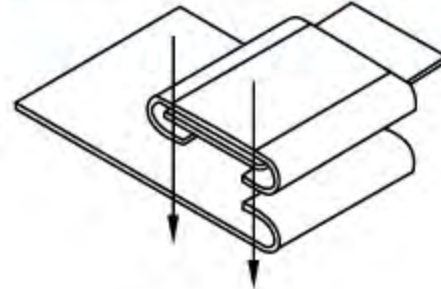

FR409

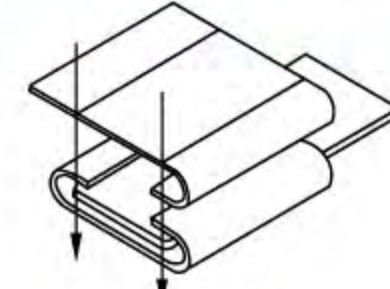

FR410



擴張滾輪組
Tubular Extending Roller Set

	TR001	TR02A	TR03A	TR05A	TR007
TR					
備註 Comment		MT4504P0, MT4004P0 標配 Standard			氣動式, 膝動開關 Pneumatic, Knee switch



精機機械廠股份有限公司
CHING CHI MACHINE CO., LTD
<http://www.kingtensexwing.com.tw>

公司: 新北市板橋區三民路2段31-33號13F

電話: (02)2961-6865 FAX: (02)2954-6007

OFFICE: 13F., NO.33, Sec2, San Min Rd. Panchiao Dist.,
New Taipei City, 22069 Taiwan, (R.O.C)

TEL: (02)2961-6865(REP)

FAX: (02)2954-6007

E-Mail: Kingtex@kingtex.com.tw

CAT NO. CX/CT-B01 / August 2023

