

Kingtex®

Cx | Cr

筒型繙縫機

Cylinder Bed Interlock Sewing Machine



# INTERLOCK

筒型繙縫機  
Cylinder Bed Interlock Machine



CXM2000 / UCP-X

**CX** Series



CTD9000 / UCP-B

**CT** Series

## CT9085 - 0 - 356M / UCP - A3 / RP003 / CS002

針數 /  
No of Needle

針距 /  
Needle  
Distance

布料厚度 / 針板舌  
Fabric Thickness / Needle Plate Tongue

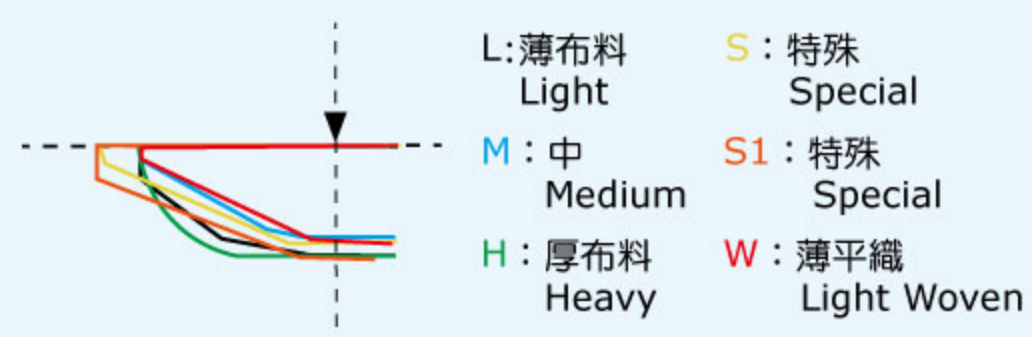

	機型 / Machine Type						車縫應用 / Application Code								選配件 / Optional Device		
	直驅 Direct- Drive	上送 Top Feeding	細筒 Small Cylinder	極細筒 Extra Small Cylinder	左切刀 Left Edge Trimmer	特厚 Extra Heavy	00 一般 General	03 上帶 Tape Binding	11 下擺 Hemming	13 壓骨 Covering	42 環帶 Tubular Band	60 四針 4-Needle Lapseam	85 右切 Right Trimme	A3 三合一 3 in 1	自動切線 Thread Trimmer	密縫 Condensed Stitch	後拖輪 Rear Puller
CT90						●	●	●	●	●	●	●	●		UCP-A	CS002	RP003
CT92						●	●	●	●	●	●	●	●		UCE-A	CS01P(9085) CS003	
CT93					●			●	●	●	●	●	●		UCP-C	CS004	RP004
CT97			●		●			●	●	●	●	●	●		UCE-C	CS04P(RP004)	
CT98			●		●			●	●	●	●	●	●				
CTD90	●					●	●	●	●	●	●	●	●		UCP-B	CS002	RP003
CTD92	●					●	●	●	●	●	●	●	●		UCE-B	CS01P(9085) CS003	
CTD93	●				●			●	●	●	●	●	●				
CTD97	●		●		●			●	●	●	●	●	●		UCP-D	CS004	RP004
CTD98	●		●		●			●	●	●	●	●	●		UCE-D	CS04P(RP004)	CS04P
CTU90	●	●				●		●	●	●	●	●	●			CS002 CS01P(9085)	
CTU91	●	●		●		●		●	●	●	●	●	●				
CTU92	●	●				●		●	●	●	●	●	●		UCP-F□ UCE-F□		
CTU93	●	●			●			●	●	●	●	●	●			CS004	
CTU97	●	●	●		●			●	●	●	●	●	●				
CTU98	●	●	●		●			●	●	●	●	●	●				
CTN91	M	●		●				●	●	●	●	●	●		UCP-FS UCE-FS		
CTM97	M		●					●	●	●	●	●	●		UCP-D UCE-D	CS004 CS04P(RP004)	RP004 RPC04
CXM20	M					●		●	●	●	●	●	●		UCP-X	CS005	RP008
CXM22	M					●		●	●	●	●	●	●		UCE-X	CS05P(RPC08)	
CXM23	M				●			●	●	●	●	●	●				
CXD27	●		●					●	●	●	●	●	●		UCP-D UCE-D	CS004 CS04P(RP004)	RP004 RPC04
CXN20	M	●				●		●	●	●	●	●	●				
CXN22	M	●				●		●	●	●	●	●	●		UCP-FX UCE-FX		
CXN23	M	●			●			●	●	●	●	●	●				



直驅  
Direct-Drive  
CTD/CTU



一體式 / 直驅  
Mechatronics  
CTM/CTN/CXM/CXN

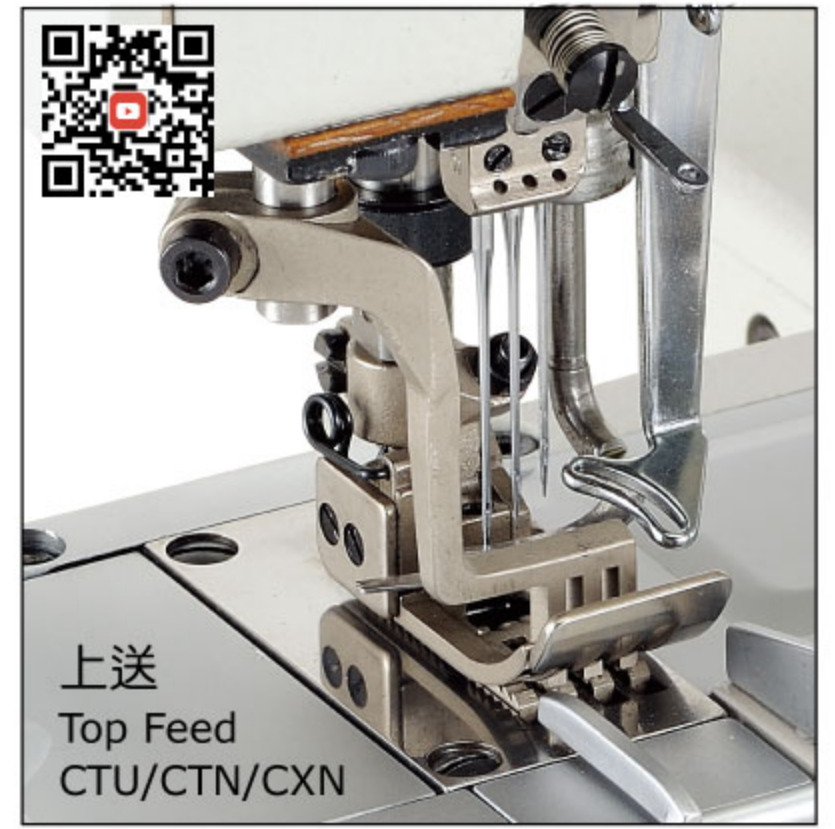

上送  
Top Feed  
CTU/CTN/CXN



左切刀  
Left Trimmer  
CT93/ CTD93/ CTU93/ CXM23



標準筒型  
Standard Bed  
CT90/ CTD90/ CTU90/ CXM20/ CXN



右切刀  
Right Trimmer  
CT9085/ CTD9085/ CXM2085

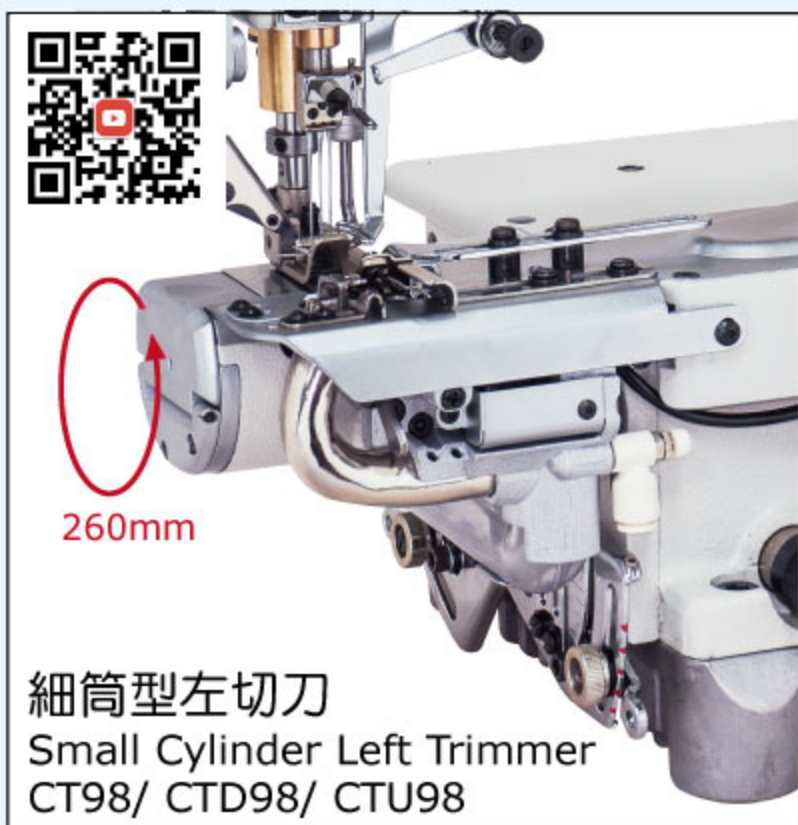

細筒型左切刀  
Small Cylinder Left Trimmer  
CT98/ CTD98/ CTU98

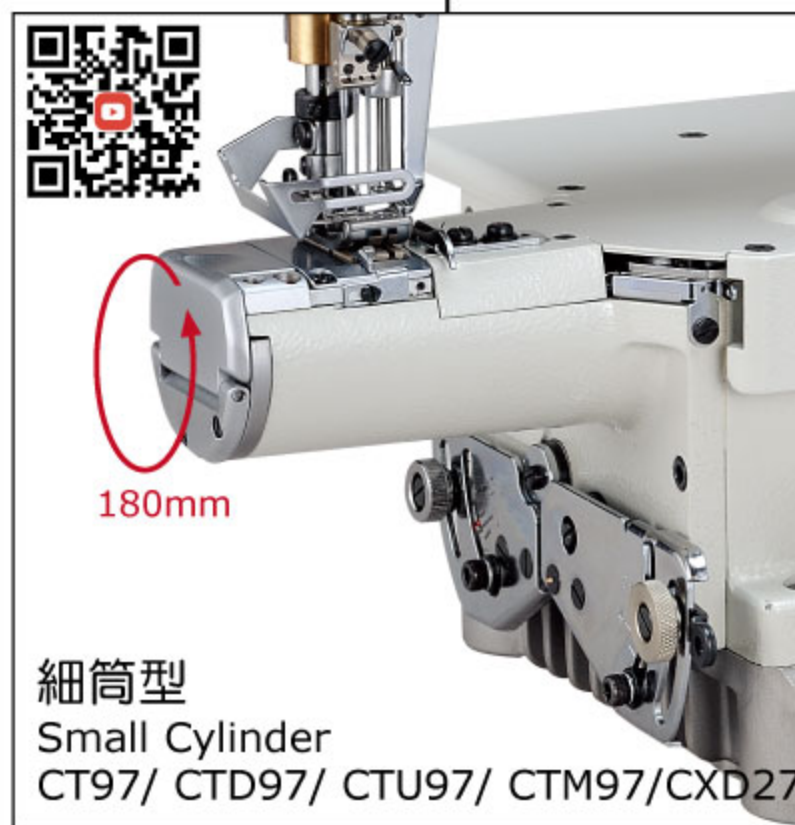

細筒型  
Small Cylinder  
CT97/ CTD97/ CTU97/ CTM97/CXD27

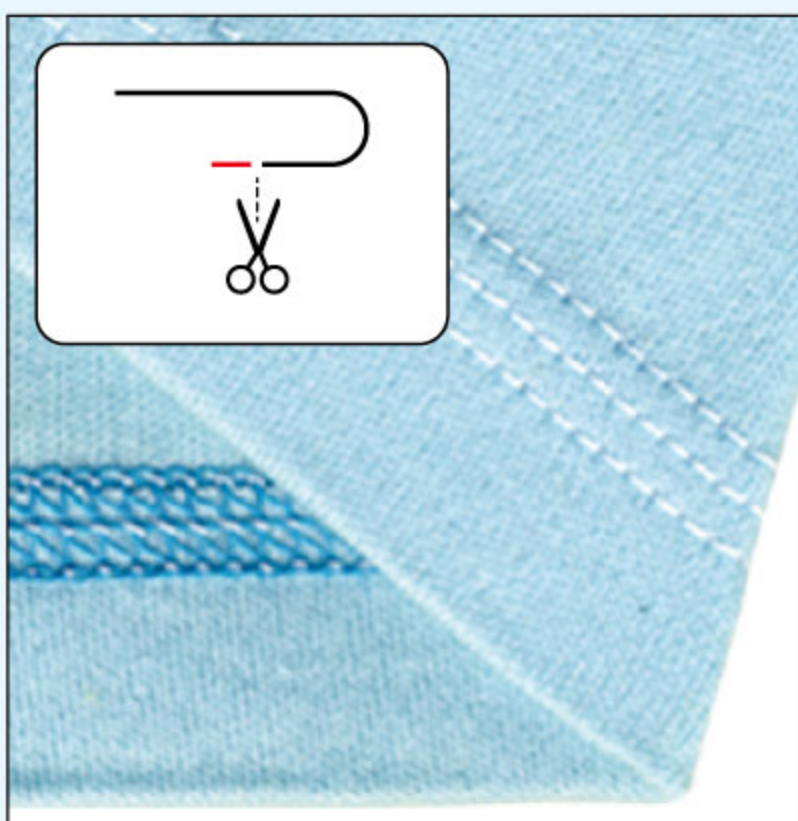

極細筒型  
Extra-Small Cylinder  
CTU91/ CTN91

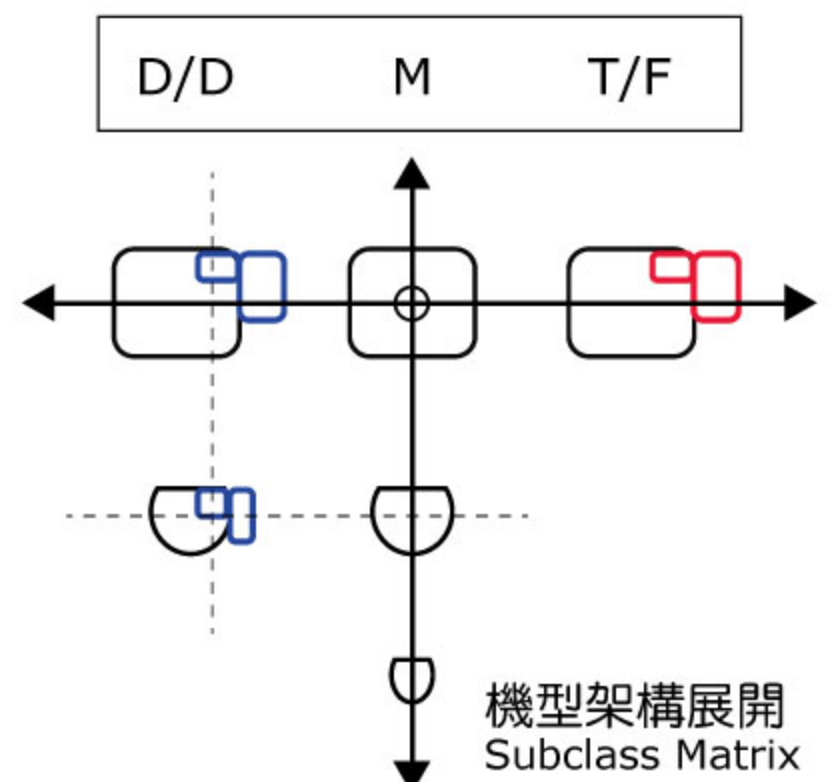

# 車縫應用 / SEWING APPLICATION

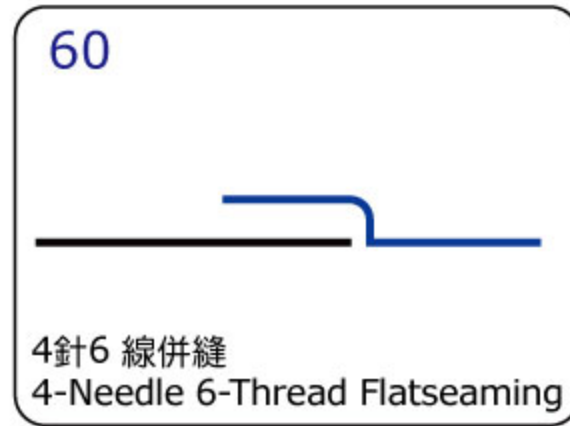
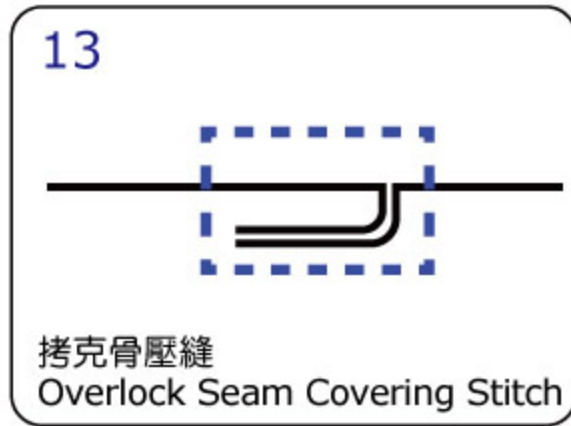
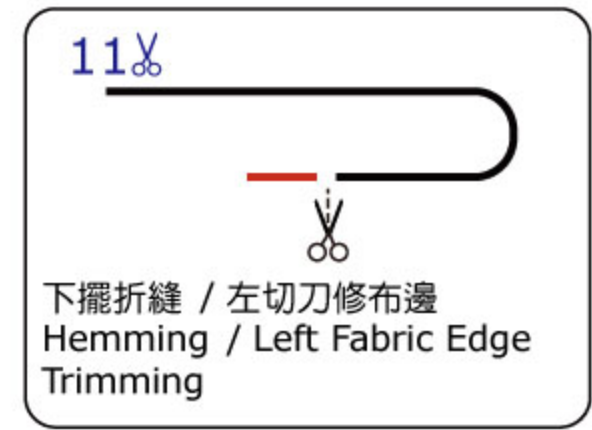
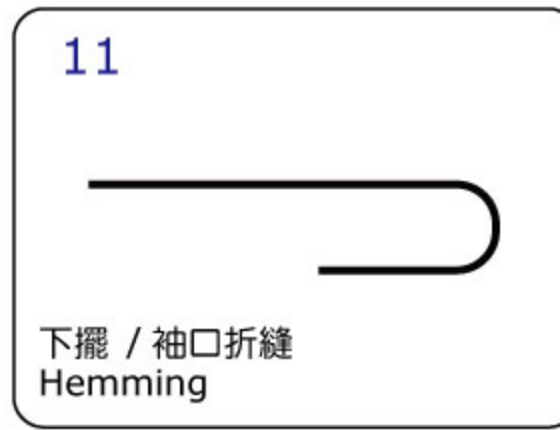
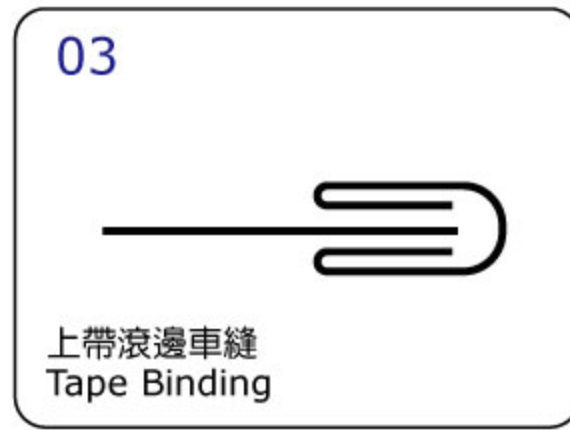
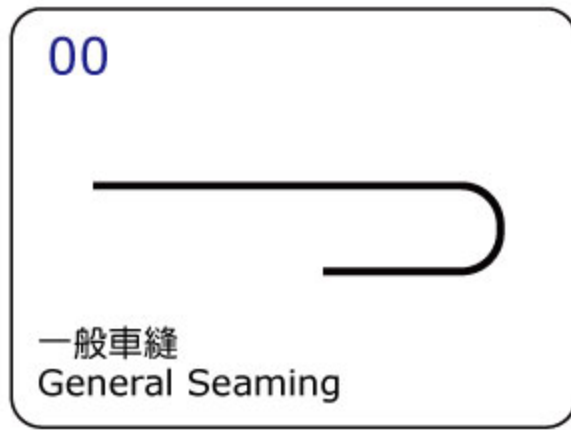

00			 m.m.	 m.m.		 m.m.	 U128 GAS +		OPTIONAL DEVICE					
CT 9000-0-□□□L CTD9000-0-□□□L	2 3	4 5	4.0/4.8 5.6/6.4	1.4~3.6	1:0.3 ? 1:2.9	5	#10	6000	UCP-□ UCE-□ RP003					
CT 9000-0-□□□M CTD9000-0-□□□M	2 3	4 5	4.0/4.8 5.6/6.4				#11							
CT 9000-0-□□□H CTD9000-0-□□□H	2 3	4 5	4.0/4.8 5.6/6.4				#14							
CT 9000-0-□□□S CTD9000-0-□□□S	2 3	4 5	4.0/4.8 5.6/6.4				#11							
CT 9000-0-□□□S1 CTD9000-0-□□□S1	2 3	4 5	4.0/4.8 5.6/6.4				#11							
CT 9000-0-□□□W CTD9000-0-□□□W	3	5	5.6/6.4				#11							
CT 9000-0-□□□H CTD9000-0-□□□H	3	5	5.6/6.4				#14			4500				
CXM2000-0-□□□L	2 3	4 5	4.0/4.8 4.8/5.6/6.4				1.4~3.6			1:0.3 ? 1:2.9	5	#10	6000	UCP-X UCE-X CS005 RP008 RPC08 BOC
CXM2000-0-□□□M	2 3	4 5	4.0/4.8 4.8/5.6/6.4									#11		
CXM2000-0-□□□H	2 3	4 5	4 4.8/5.6/6.4									#14		
CXM2000-0-□□□H1	3	5	5.6	#14										
CXM2000-0-□□□S	2 3	4 5	4.0/4.8 4.8/5.6/6.4	#11										
CXM2000-0-□□□S1	2 3	4 5	4.0/4.8 4.8/5.6/6.4	#11										
CXM2000-0-□□□S2	3	5	4.8/5.6/6.4	#11										
CXM2000-0-□□□S3	3	5	4.8/5.6/6.4	#11										
CXM2000-0-□□□W	3	5	4.8/5.6/6.4	#11										
CXM2000-0-□□□H	3	5	4.8/5.6/6.4	#14	4500									











## 一般車縫 General Seaming

本機型為三針車基本規格，適用範圍含蓋薄至厚各種面料，可選配附件以進行各類車縫。

The basic model is with full specification for the all range of fabric thickness. Various devices are optional for sewing applications.



CT9000

03			 m.m.	 m.m.		 m.m.	 UV128 GAS	 S.P.M.	OPTIONAL DEVICE
CT 9003-0-□□□M CTD9003-0-□□□M	2	4	4.0	1.4~3.6	1:0.3 ? 1:2.9	5	#10	6000	UCP-□ UCE-□ RP003
	2	4	4.8						
	3	5	5.6						
	3	5	6.4						

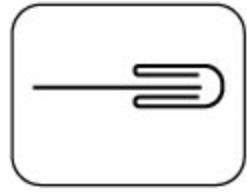





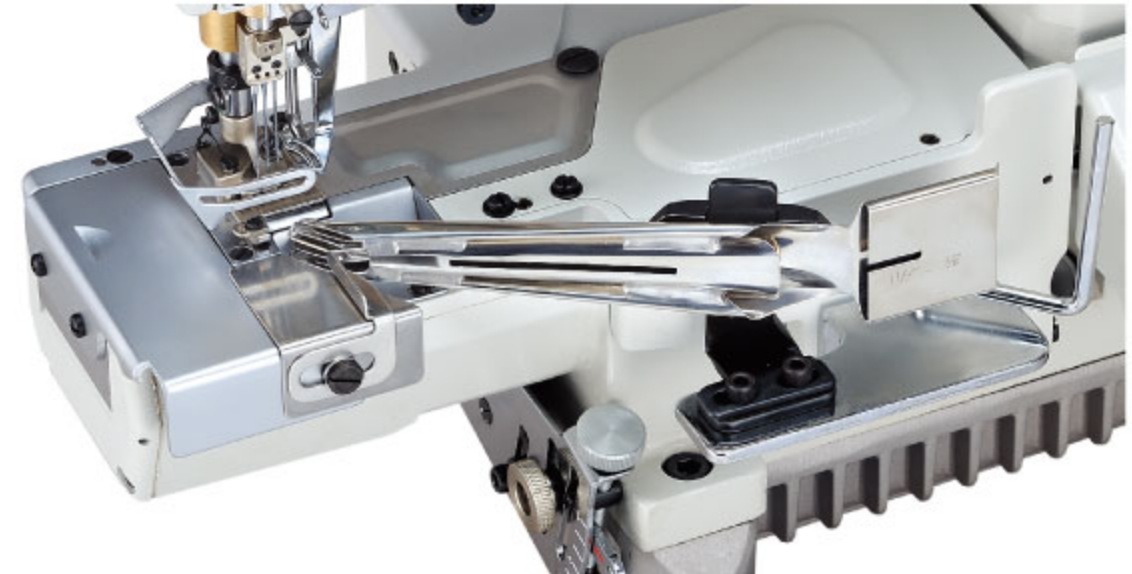

上帶滾邊車縫  
Tape Biding

本機型適用於T恤領口，運動褲褲管口之滾邊車縫。

For tape binding on the openings of T-shirt and sports short.

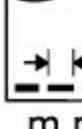

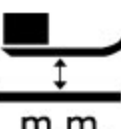
CT9003

11			 m.m.	 m.m.		 m.m.	 UV128 GAS	 S.P.M.	OPTIONAL DEVICE
CT 9011-0-□□□M CTD9011-0-□□□M	2	4	4.0/4.8	1.4~3.6	1:0.3 ? 1:2.9	5	#11	6000	UCP-□ UCE-□ RP003
	3	5	5.6/6.4						
CT 9711-0-□□□M CTD9711-0-□□□M	2	4	4.0/4.8						
	3	5	5.6/6.4						
CXD2711-0-□□□M	2	4	4.0/4.8						
	3	5	5.6/6.4						
CTU9111-0-□□□M	2	4	4.0/4.8	3000	UCP-FS UCE-FS				
	3	5	4.8/5.6/6.4						

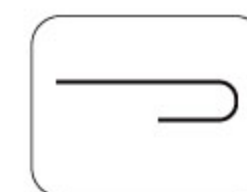

下擺/袖口折縫  
Hemming

從下擺折縫、袖口折縫到嬰兒衣袖口折縫，有各3種規格的筒嘴 (外徑：280/ 180/ 110 mm) 可以對應各種車縫需求。

For the hemming of T-shirt Bottom, sleeve, and infant wear, there are 3 kinds of cylinder bed (circumference: 280/ 180/ 110 mm) to meet the demands.

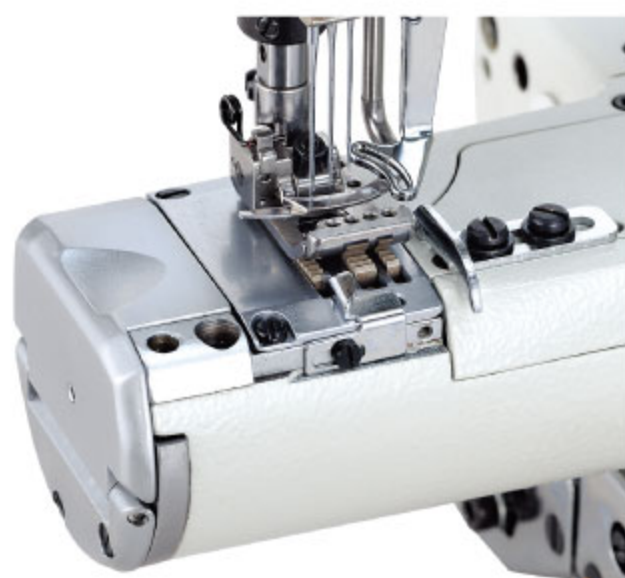



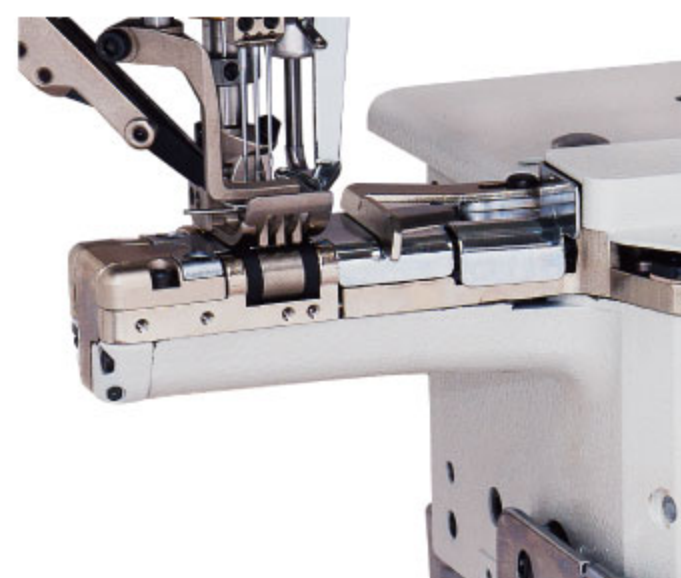



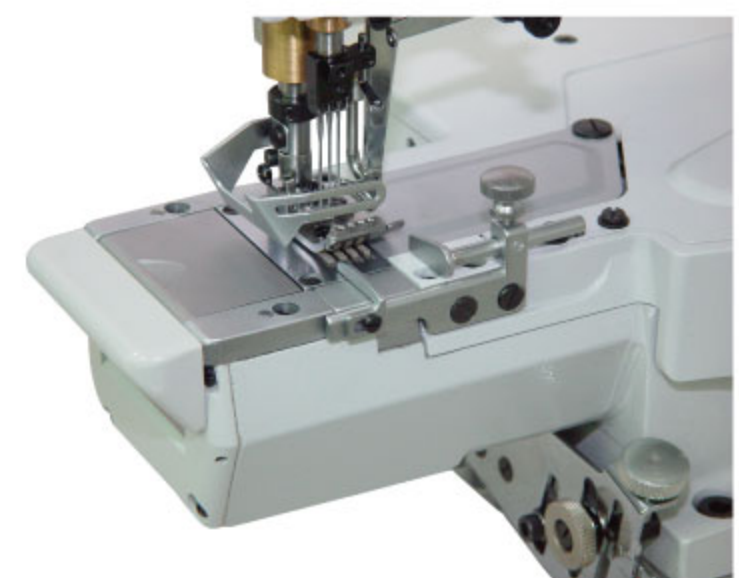

CTD9711(180mm)

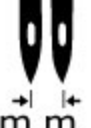

CTU9111(110mm)



CT9011(280mm)

11 ✂			 m.m.	 m.m.		 m.m.	UY128 GAS 	S.P.M. 	OPTIONAL DEVICE
CT9311-0-□□□M	2	4	4.0/4.8	1.4~3.6	1:0.3 ? 1:2.9	5	#11	4500	UCP-A UCE-A CV17A TR02A
CT9311-0-□□□S	3	5	5.6/6.4						
CT9311-0-□□□S1	2	4	4.0/4.8						
CTD9311-0-□□□M	2	4	4.0/4.8	1.4~3.6	1:0.3 ? 1:2.9	5	#11	4500	UCP-B UCE-B CV17A TR02A
CTD9311-0-□□□S	3	5	5.6/6.4						
CTD9311-0-□□□S1	3	5	4.0/4.8						
CTD9311-0-□□□S1	3	5	5.6/6.4	1.4~3.6	1:0.3 ? 1:2.9	5	#11	4500	UCP-D UCE-D CV TR02A
CTD9811-0-□□□M	2	4	4.0/4.8						
CTD9811-0-□□□S	3	5	5.6/6.4						
CTD9811-0-□□□S1	2	4	4.0/4.8	1.4~3.6	1:0.3 ? 1:2.9	5	#11	4500	UCP-X5 UCP-X6 CS005 RP008 RPC08
CXM2311-0-□□□M	3	5	4.0/4.8						
CXM2311-0-□□□H	3	5	5.6/6.4						
CXM2311-0-□□□S	2	4	4.0/4.8	1.4~3.6	1:0.3 ? 1:2.9	5	#11	4500	UCP-X5 UCP-X6 CS005 RP008 RPC08
CXM2311-0-□□□S1	3	5	5.6/6.4						
CXM2311-0-356L	2	4	4.0/4.8						
CXM2311-0-356S2	3	5	5.6	1.4~3.6	1:0.3 ? 1:2.9	5	#11	4500	UCP-X5 UCP-X6 CS005 RP008 RPC08
CXM2311-0-356S3	3	5	6.4						

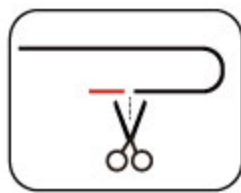

## 下擺/左切刀修布邊 Hemming / Left fabric edge trimmer



在進行下擺折縫之前，先以左切刀修齊布邊，以達完美的車縫品質。

另外，CTD9811 與 CXM2311 標配吹氣式防捲布功能。

Hemming with pre-cutting function by the left fabric edge trimmer.

Moreover, CTD9811 and CXM2311 are equipped with air-blow type anti-curling edge function.

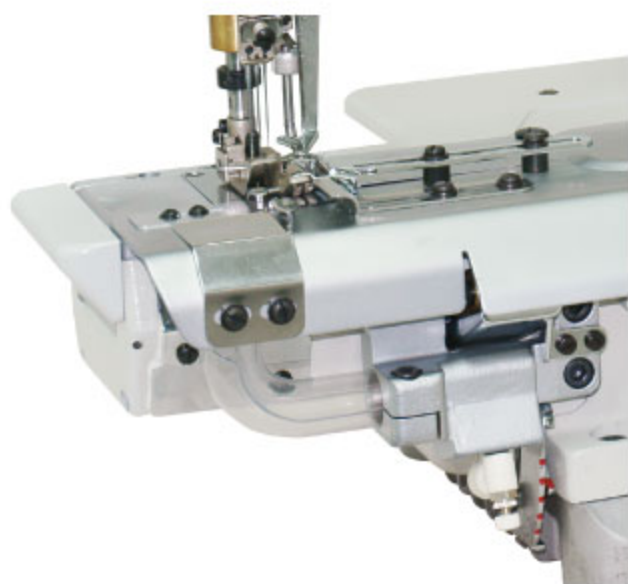
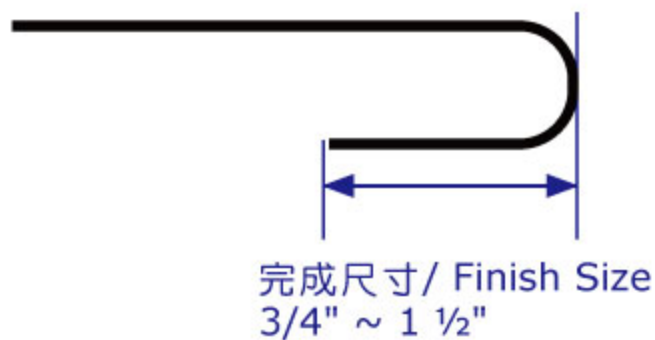



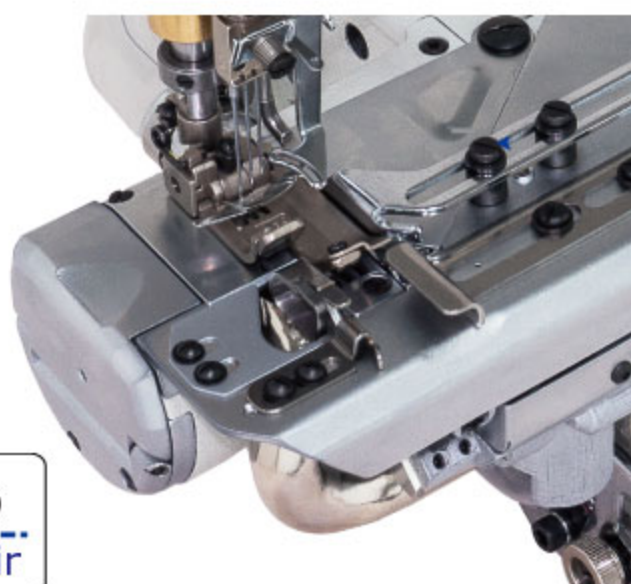



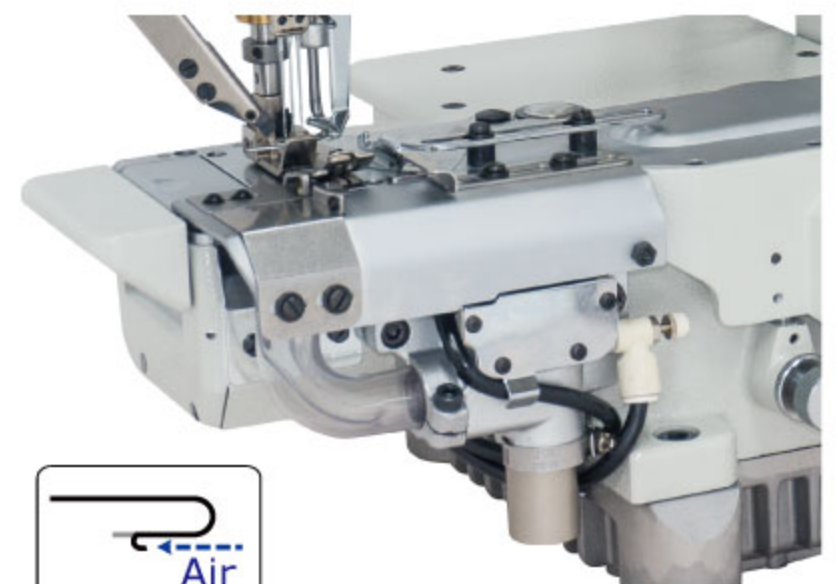

CT9311 / CTD9311



CTD9811



CXM2311

13			 m.m.	 m.m.		 m.m.	UV128 GAS 	 S.P.M.	OPTIONAL DEVICE						
CT 9013-0-□□□M CTD9013-0-□□□M	2 3	4 5	4.0 4.8/5.6/6.4	1.4~3.6	1:0.3 ? 1:2.9	5	#11	6000	UCP-□ UCE-□ RP003						
CT 9013-1-□□□M CTD9013-1-□□□M	2 3	4 5	4.0 4.8/5.6/6.4												
CT 9013-2-□□□M CTD9013-2-□□□M	2 3	4 5	4.0 4.8/5.6/6.4												
CT 9713-0-□□□M CTD9713-0-□□□M	2 3	4 5	4.0 4.8/5.6/6.4												
CT 9713-1-□□□M CTD9713-1-□□□M	2 3	4 5	4.0 4.8/5.6/6.4												
CT 9713-2-□□□M CTD9713-2-□□□M	3 3	5 5	4.0 4.8/5.6/6.4												
CXD2713-0-□□□M CXD2713-1-□□□M CXD2713-2-□□□M	2 3 2 3	4 5 4 5	4.0 4.8/5.6/6.4 4.0 4.8/5.6/6.4	1.4~3.6	1:0.3 ? 1:2.9	5	#11	6000	UCP-D UCE-D RP004 RPC04						
CXM2013-0-□□□M CXM2013-1-□□□M CXM2013-2-□□□M	2 3 2 3	4 5 4 5	4.0 4.8/5.6/6.4 4.0 4.0/4.8 4.8/5.6/6.4							1.4~3.6	1:0.3 ? 1:2.9	5	#11	6000	UCP-X□ UCE-X□ RP008 RPC08

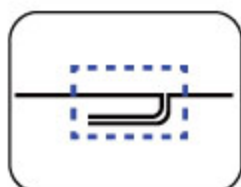

拷克骨壓縫  
Overlock Seam Covering Stitch

拷克骨壓縫有倒骨式(適用4線拷克),  
與立骨式(適用3線拷克)

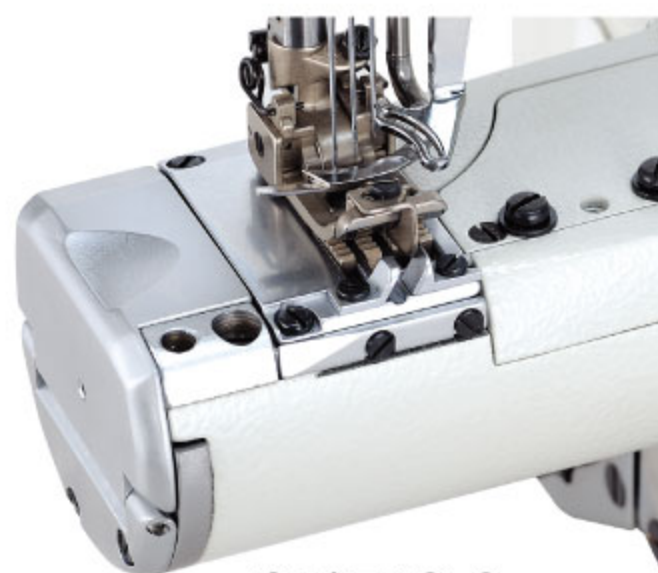

Overlock seam covering stitch by  
Fold type  
(4-thread overlock seam applicable)  
and Flattening type  
(3-thread overlock seam applicable)







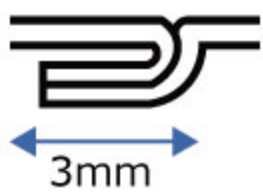

CT9713-0

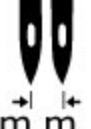

CXM2013-2

<p><b>13-0</b></p> <p>倒骨式 Fold type</p>  <p>3mm</p>		
<p><b>13-1</b></p> <p>立骨式 Flattening type</p> 		
<p><b>13-2</b></p> <p>倒骨式 Fold type</p>  <p>6mm</p>		

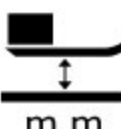
# 車縫應用 / SEWING APPLICATION

42			 m.m.	 m.m.		 m.m.	 UY128 GAS		OPTIONAL DEVICE
CT 9042-0-3□□M CTD9042-0-3□□M	3	5	5.6 6.4	1.4~3.6	1:0.3 ? 1:2.9	5	#11	5500	UCP-□ UCE-□ RP003
CT 9042-2-3□□M CTD9042-2-3□□M	3	5	5.6 6.4		1:0.3 ? 1:2.9	5	#11	5500	UCP-X UCE-X RP008 CS005

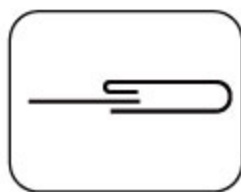

## 環形針織褲腰鬆緊帶接縫 Knitted Elastic Ring Attaching



導布器以膝動開關操作，由空壓設備提供動力，有氣動閥式(42-0)與機械閥式(42-2)可供選擇

The tape guide is controlled by knee switch and is powered by air compressor. The options are pneumatic valve type (42-0) and mechanical valve type (42-2).

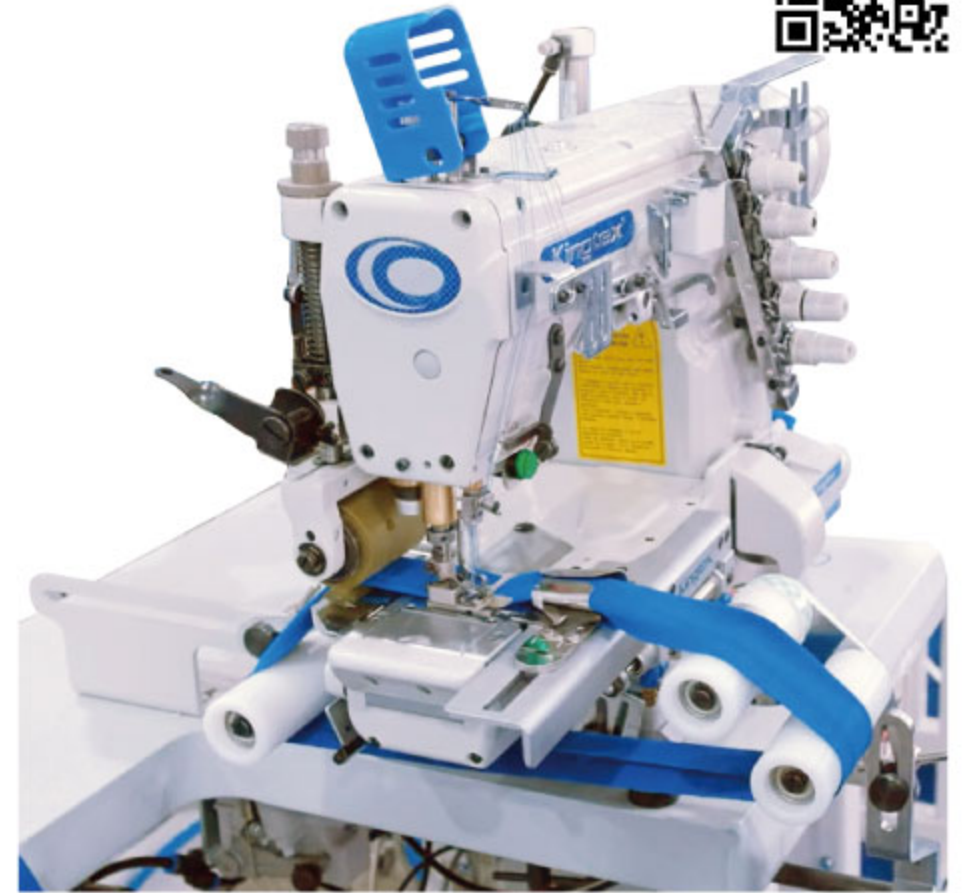
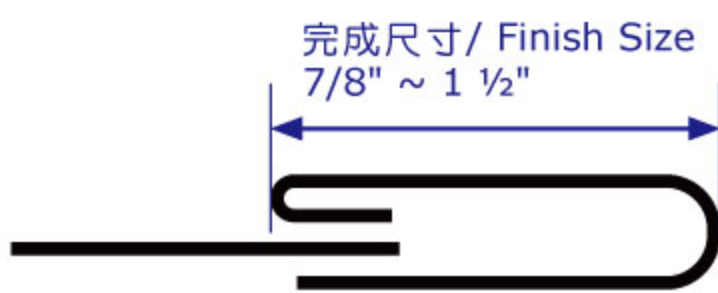

CT9042-0





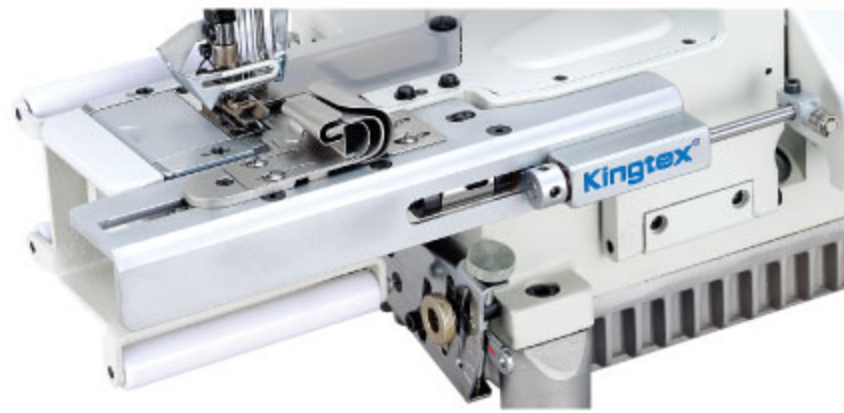

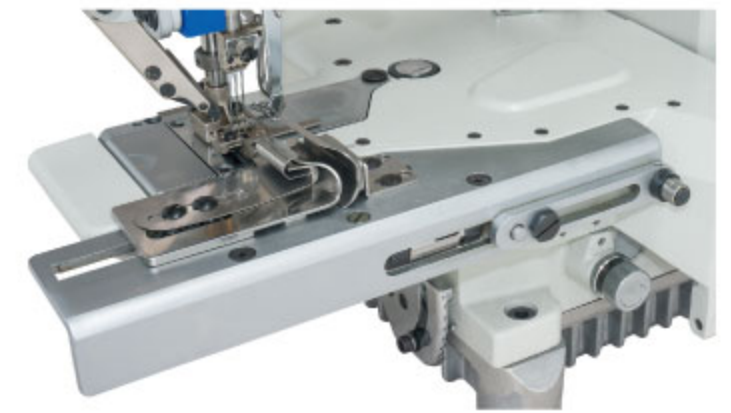

CT9042-0 (氣動式/Pneumatic type)



CT9042-2 (膝動式/Manual type)

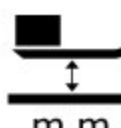

CXM2042-2 (膝動式/Manual type)

60			 m.m.	 m.m.		 m.m.	 MY1014B		OPTIONAL DEVICE
CT 9060-0-4□□M CTD9060-0-4□□M	4	6	5.2/5.6 6.0/6.4		1:0.7				UCP-□A
CT 9760-0-4□□M CTD9760-0-4□□M	4	6	5.6/6.0/6.4	1.4~3.6	1:0.7 ? 1:2.0	5	#11	6000	UCP-□A
CXD2760-0-4□□M	4	6	5.6/6.0/6.4						UCP-DA

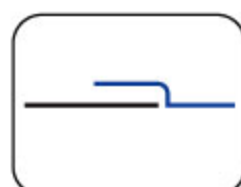

## 四針六線併縫 4-Needle 6-Thread Flatseaming





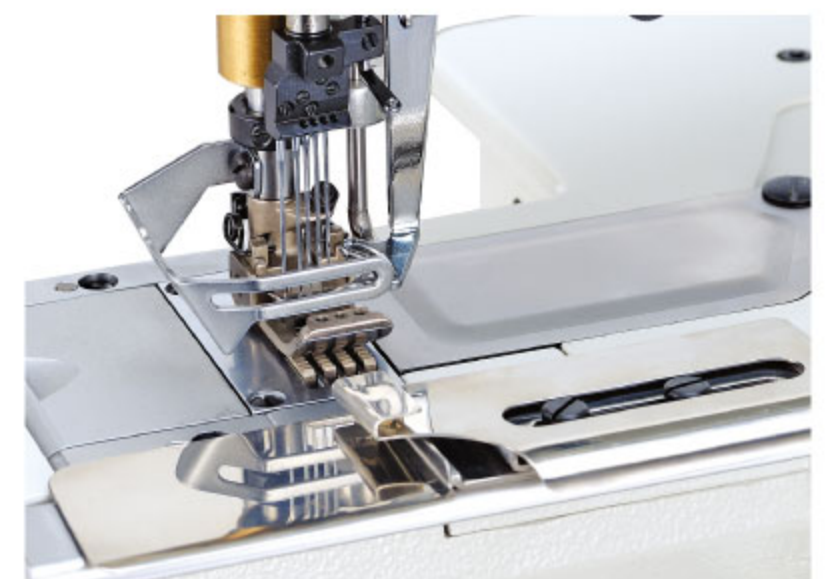



CT9760

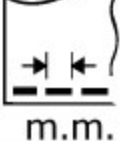

CT9060

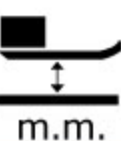

85			 m.m.	 m.m.		 m.m.	UV128 GAS 	 S.P.M.	OPTIONAL DEVICE
CT9085-0-240-M CT9085-0-248-M CT9085-0-356-M CT9085-0-364-M	2 2 3 3	4 4 5 5	4.0 4.8 5.6 6.4	1.4~3.6	1:0.3 ? 1:2.9	5	#11	4500	UCP-A RP003 CS005
CTD9085-0-240-M CTD9085-0-248-M CTD9085-0-356-M CTD9085-0-364-M	2 2 3 3	4 4 5 5	4.0 4.8 5.6 6.4	1.4~3.6	1:0.3 ? 1:2.9	5	#11	4500	UCP-B RP003 CS005
CXM2085-0-240-M CXM2085-0-248-M CXM2085-0-356-M CXM2085-0-364-M	2 2 3 3	4 4 5 5	4.0 4.8 5.6 6.4	1.4~3.6	1:0.3 ? 1:2.9	5	#11	4500	UCP-X RP008 CS005

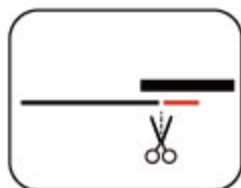

環形鬆緊帶褲腰接縫/右切刀修布邊  
Elastic Waistband Ring Attaching/ Right Fabric Edge Trimming



在進行環形鬆緊帶褲腰接縫之前，先以右切刀修齊布邊，以達完美的車縫品質。  
另外，CXM2085 標配吹氣式壓腳，具有防捲布功能。

Elastic waistband ring attaching with pre-cutting function by the right fabric edge trimmer.  
Moreover, CXM 2085 is equipped with air-blow type presser foot for anti-curling edge function.

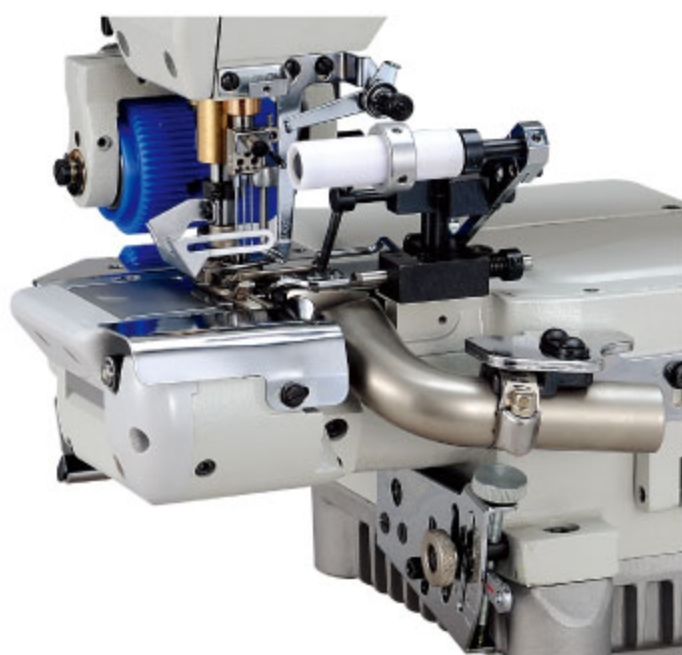

CT9085 / CTD9085

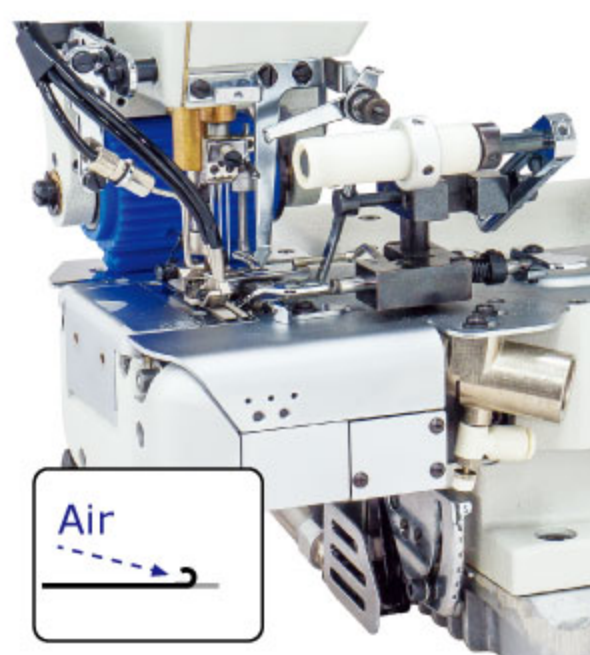









CXM2085



AF001: Air-blow type Presser foot

# 車縫應用 / SEWING APPLICATION

U / N			 m.m.	 m.m.			 m.m.	 S.P.M.	OPTIONAL DEVICE	SEWING APPLICATION							
CTU9011-0-□□□M	2 3	4 5	4.8 5.6/6.4	1.4~3.6	1:0.3~ 1:2.9	1~6	5	#11 5500	UCP-FB UCE-FB	<b>11</b>							
CTU9111-0-□□□M	2 3	4 5	4.0/4.8 4.8/5.6/6.4	0.8~3.3	/	1~6	5	#11 3000	UCP-FS UCE-FS	<b>11</b>							
CTU9160-0-□□□M	4	6	6.0					MY1014B #11 3000	UCP-FSA UCE-FSC	<b>60</b>							
CTU9711-0-□□□M	2 3	4 5	4.8 5.6/6.4	1.4~3.6	1:0.3~ 1:2.9	1~6	5	#11 4500	UCP-FB UCE-FB	<b>11</b>							
CXN2000-0-□□□M	3	5	5.6/6.4	1.4~3.6	1:0.3 ? 1:2.9	1~6	5	#11 6000	UCP-FX UCE-FX	<b>00</b>							
CXN2000-0-□□□H	3	5	5.6/6.4														
CXN2000-0-356H1	3	5	5.6														
CXN2000-0-□□□W	3	5	5.6/6.4														
CXN2000-0-□□□L	3	5	5.6/6.4														
CXN2000-0-□□□S	3	5	5.6/6.4														
CXN2000-0-□□□S1	3	5	5.6/6.4														
CXN2000-0-□□□S2	3	5	5.6/6.4														
CXN2000-0-□□□S3	3	5	5.6/6.4														
CXN2011-0-□□□M	2 3	4 5	4.0 4.8/5.6/6.4								1.4~3.6	1:0.3 ? 1:2.9	1~6	5	#11 6000	UCP-FX1 UCE-FX1	<b>11</b>
CXN2011-0-□□□L	2 3	4 5	4.0 4.8/5.6/6.4														
CXN2011-0-□□□S	2 3	4 5	4.0 4.8/5.6/6.4														
CXN2011-0-□□□S1	2 3	4 5	4.0 4.8/5.6/6.4														
CXN2011-0-□□□H	2 3	4 5	4.0 4.8/5.6/6.4														
CXN2011-0-□□□W	3	5	5.6/6.4														
CXN2013-0-□□□M	3	5	5.6/6.4	1.4~3.6	1:0.3 ? 1:2.9	1~6	5	#11 6000	UCP-FX1 UCE-FX1	<b>13</b>							
CXN2013-1-□□□M	3	5	5.6/6.4														
CXN2013-2-□□□M	3	5	5.6/6.4														
CXN2060-0-460M	4	6	6.0	1.4~3.6	1:0.3~ 1:2.9	1~6	5	MY1014B #11 5500	UCP-FXA	<b>60</b>							
CXN2200-0-□□□H	3	5	5.6/6.4	1.4~3.6		1~6	5	#14 4500	UCP-FX1 UCE-FX1	<b>00</b>							

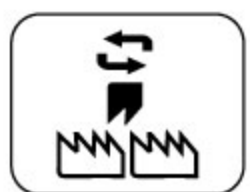

上送機型  
Top Feed Models



CXN2000















CTU9711



CTU9111



U / N			 m.m.	 m.m.			 m.m.	 UY128 GAS	 S.P.M.	OPTIONAL DEVICE	SEWING APPLICATION
CTU9311-0-3□□M	3	5	5.6/6.4	1.4~3.6	1:0.3~ 1:2.9	1~6	5	#11	4500	UCP-FB UCE-FB	11 
CTU9811-0-□□□M	2 3	4 5	4.0/4.8 5.6/6.4	1.4~3.6	1:0.3 ? 1:2.9	1~6	5	#11	4500	UCP-FD UCE-FD	11 
CTU9811-0-□□□S	2 3	4 5	4.0/4.8 5.6/6.4								
CTU9811-0-□□□S1	2 3	4 5	4.0/4.8 5.6/6.4								
CXN2311-0-□□□M CXN2311-1-□□□M	2 3	4 5	4.0/4.8 4.8/5.6/6.4								
CXN2311-0-356M	3	5	5.6	1.4~3.6	1:0.3 ? 1:2.9	1~6	5	#11	5000	UCP-FX5 UCE-FX6	11 
CXN2311-0-□□□S CXN2311-1-□□□S	2 3	4 5	4.0 4.8/5.6/6.4								
CXN2311-0-□□□S1 CXN2311-1-□□□S1	2 3	4 5	4.0 4.8/5.6/6.4								
CXN2311-0-□□□S2	3	5	5.6/6.4								
CXN2311-0-□□□H1 CXN2311-1-□□□H1	2 3	4 5	4.0/4.8 4.8/5.6/6.4								



上送機型  
Top Feed Models

上送並搭配左切刀的高階機型，具有豐富規格，可對應各種車縫情形。

The high-end models of top feeding with left fabric edge trimmer, which have a wide range of specifications, can be used in various sewing situations.



CTU9311







CTU9811



CTU9111

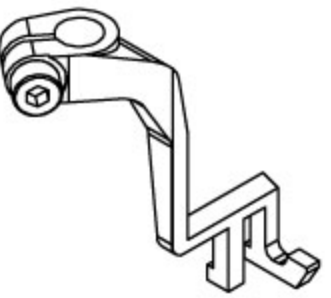

CTU9311

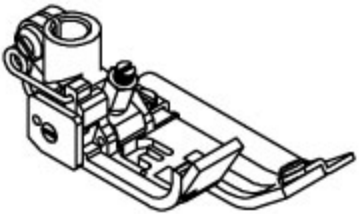
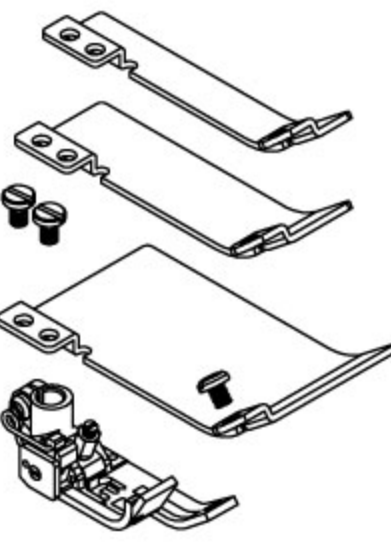
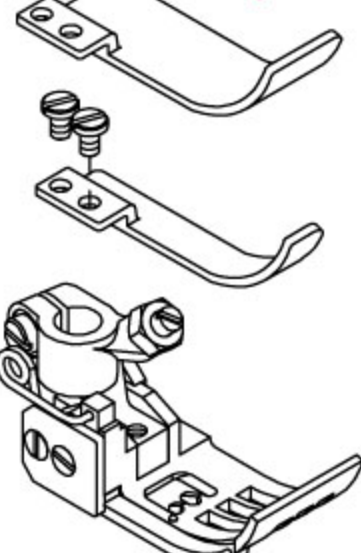
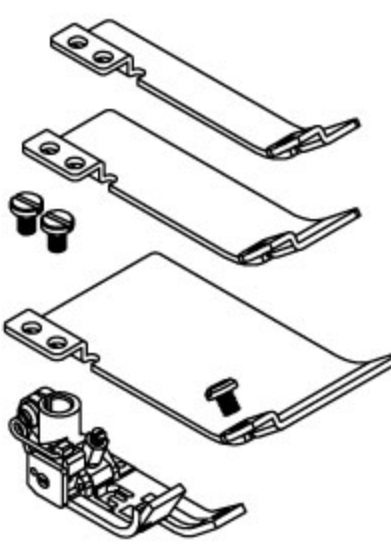
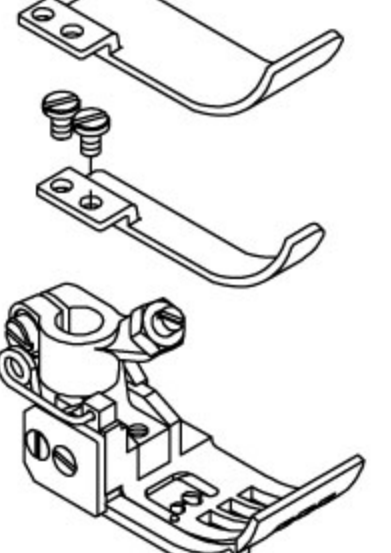
	CTU9311	CTU9811		CXN2311-0	CXN2311-1
上送齒 Top Feed Deg			 Optional		
壓腳 Presser Foot			 Optional		

# 選配件 / OPTIONAL DEVICE

## 自動切線組 Auto Thread Trimmer Set

<b>UCE-A1</b> ① ② ③ ④	① 自動切線裝置代號 Under bed thread trimmer device
	② 機型 C:方筒型繡縫機 F:平台型繡縫機 Model C:Cylinder bed interlock F:Flat bed interlock
	③ 動力 P:氣動式 E:電動式 Power P:Pneumatic Type E:Electric Type
	④ 裝置組合代號 Combination of devices

## UCP-□□ UCE-□□



## 電動式切線組 Elastic Type Thread Trimmer

UCE -□□	下切 Under Trimmer	上切 Top Trimmer	撥線 Wiper (WPG)	抬壓腳 Presser Foot Lifter	適用機型 Application
A1		STC02			
A2	UTC04		✓	✓	CT9000
A3		STC02	✓*		
A4					
B1		STC03			
B2	UTC03		✓	✓	CTD9000
B3		STC03	✓*		
B4					
C1		STC02			
C2	UTC06		✓	✓	CT9700
C3		STC02	✓*		
C4					
D1		STC03			
D2	UTC07		✓	✓	CTD9711 CXD2711
D3		STC03	✓*		
D4					
X1		STC03			
X2	UTC09		✓	✓	CXM2000
X3		STC03	✓*		
X4					
FX1		STC04			
FX2	UTC09F		✓	✓	CXN2000
FX3		STC04	✓*		
FX4					
FS1		STC05			
FS2	UTC10F		WPG02	✓	CTU9111 CTN9111
FS3		STC05	WPG02*		
FS4					
FS4					

\* 包裝於附件箱中/ Packed in the accessories box

## 氣動式切線組 Pneumatic Type Thread Trimmer

UCP -□□	下切 Under Trimmer	上切 Top Trimmer	撥線 Wiper (WPC)	抬壓腳 Presser Foot Lifter	氣閥 Valve	適用機型 Application				
A1		STB02								
A2	UTB02		✓	✓	2	CT9000				
A3		STB02	✓*							
A4										
A5		UTG02	✓				✓	3	CT9311 CT9085	
A6			✓							
A7		✓								
A8	UTH02		✓	✓	3	CT9000 上下切獨立控制				
A9		✓	✓*							
AA	UTB04	✓		✓	2	CT9060				
B1		STB03								
B2	UTB03		✓	✓	2	CTD9000				
B3		STB03	✓*							
B4										
B5		UTG03	✓				✓	3	CTD9311 CTD9085	
B6			✓							
B7		✓								
B8	UTH03		✓	✓	3	CTD9000 上下切獨立控制				
B9		✓	✓*							
BA	UTB05	✓		✓	2	CTD9060				
C1		STB02								
C2	UTB06		✓	✓	2	CT9711				
C3		STB02	✓*							
C4										
C5		UTG10	✓				✓	3	CT9811	
C6			✓							
CA	UTB06B	✓		✓	2	CT9760				
D1		STB03								
D2	UTB07		✓	✓	2	CTD9711 CXD2711				
D3		STB03	✓*							
D4										
D5		UTG11	✓				✓	3	CTD9811	
D6			✓							
DA	UTB07B	✓		✓	2	CTD9760 CXD2760				
X1		STB03								
X2	UTB09		✓	✓	2	CXM2000				
X3		STB03	✓*							
X4										
X5		UTG09	STB03				✓	3	CXM2311 CXM2085	
X6			✓							
X7		STB03								
X8	UTH09		✓	✓	3	CXM2000 上下切獨立控制				
X9		STB03	✓*							
XA	UTB09B	STB03		✓	2	CXM2060				
XC		STB03	✓*							
FX1		STB04								
FX2		UTB09F					WPC03	✓	2	CXN2000
FX3	STB04		WPC03*							
FX4										
FX5	UTG09F		STB04	✓	3	CXN2311				
FX6			WPC03							
FX7	UTH09F	STB04		✓	3	CXN2000 上下切獨立控制				
FX8			WPC03							
FX9		STB04	WPC03*							
FXA		UTB09BF	STB04					✓	2	CXN2060
FXC		STB04	WPC03*							
FS1	UTB10F	STB05		✓	2	CTU9111 CTN9111				
FS2			WPC04							
FS3		STB05	WPC04*							
FS4										
FSA	UTB10BF	STB05		✓	2	CTU9160 CTN9160				
FSC		STB05	WPC04							

\* 包裝於附件箱中/ Packed in the accessories box

\*\* 氣動UT組尾碼, 無: SMC, C:氣立

空壓需求 Compressed Air	氣壓 Air Pressure (kgf/cm <sup>2</sup> )	消耗量 * Consumption (liter/ min)
UCP (Thread Trimming Only)	4~5	10
UCP + Fabric Trimmer (CTD 9085/9311, CX 2085/2311)	5~6	40



\* 經驗值供參考  
\* Empirical value for reference

## 密縫裝置 Condensed Stitch Device



CS	適用機型 Application
CS01P	CT / CTD9085
CS002	CT / CTD90□□
CS003	CT / CTD9311
CS004	CT / CTD97□□/ CXD27□□
CS005	CXM20□□
CS05P	CXM20□□/RP08 壓腳/托輪連動型 presser foot / Read puller Synchroized

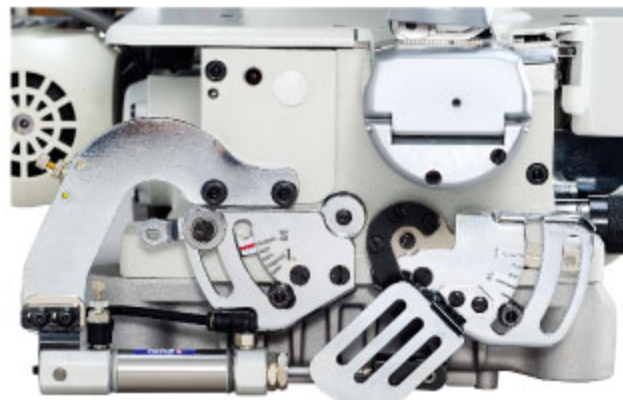
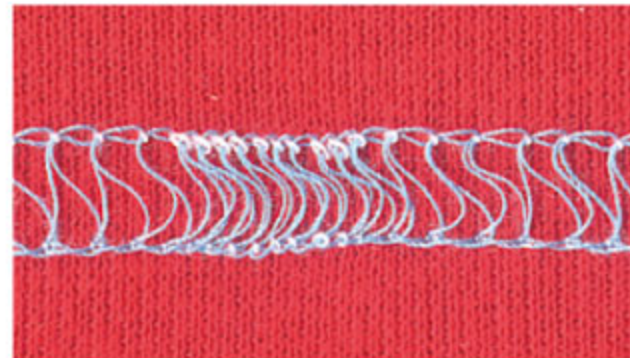

CS004



CS005/CS05P

空壓需求: 5kg/ cm<sup>2</sup> 或 70 psi 以上  
Air compressor: 5kg/ cm<sup>2</sup> or 70 psi above

## 擴張滾輪組 Tubular Extending Roller Set



TR	TR001	TR02A	TR03A	TR05A	TR007
標配 Standard	CT□□42		CT9085, CXM2085		
選配 Optional		CT□□42, CT□□11, CT9085, CXM2085		CT□□42, CT□□85, CT9085, CXM2085	氣動式, 膝動開關 Pneumatic, Knee switch

## 後拖輪組 Rear Puller Set

RP	適用機型 Application	上下齒輪數 Upper / Lower Rollers (Teeth)		
		A (標配) Standard	E (選配) Optional	F (CT9042) (CXM2042)
RP003□ RPC03□	CT9000 CT9300			
RP004□ RPC04□	CT9700 CXD2700	上/Upper 30 下/Lower 15	上/Upper 50 下/Lower 25	上/下輪 橡膠平輪 Upper / Lower Flat Rubber
RP008□ RPC08□	CXM20□□			



RP003□  
RPC03□



RP004□  
RPC04□



RP008□  
RPC08□

## 雙重上飾線 Double Covering Stitch

<b>DC</b>	適用機型 Application
DC001	CT9000
DC002	CTD9000



## 氣壓式壓腳穩壓裝置 Pneumatic Presser Foot Pressure Regulator

### AL015

具精密調壓閥，壓腳的壓力數字化設定，當車縫中面料厚度改變時，壓力控制穩定。

With the air pressure valve, the pressure value is done by digital setting. When sewing across the material thickness changing, the pressure keeps constant.



## 氣動式下擺折縫導布 Pneumatic Hemming Edge Guide

配備光學感應器，動作精準。  
Equipped With optical sensor for accurate sewing.

<b>EG</b>	適用機型 Application
EG009	CT / CTD / CTU9011
EG010	CT / CTD / CTU9311

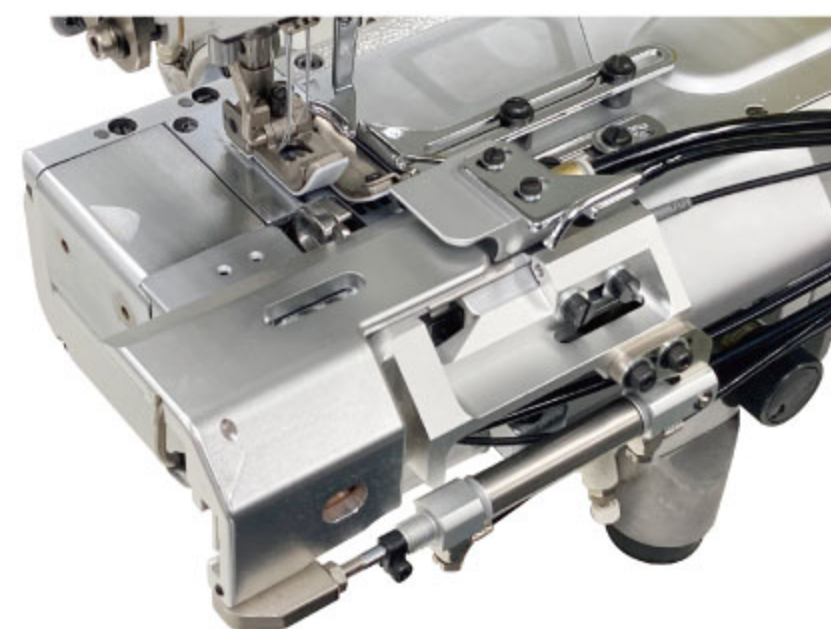

## 氣動式切帶 Pneumatic Tape Cutter

最大切斷寬 18mm，刀口距離壓腳 28mm  
Max. cutting width 18 mm. The gap between knife and presser foot is 28 mm.

<b>TCS</b>	適用機型 Application
TCS31	CTD9700
TCS32	CXM2000

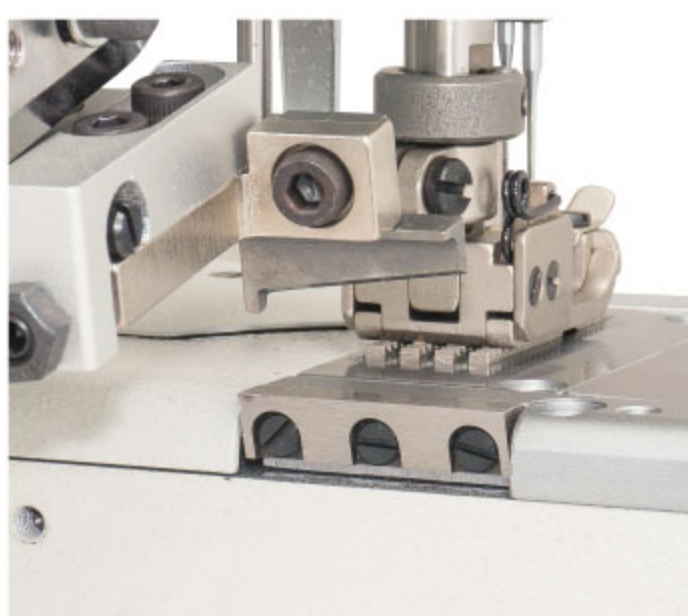

氣動式吹氣裝置  
吹氣式布邊防捲裝置  
Air-Blowing Type Anti-Curling Device

**UN002**

左切刀修布機型CT□9311適用，CTD 9811  
與CXM 2311 為標準配備。

Left edge trimmer model, CT□9311, is  
compatible. And it is standard equipment of  
CT 9811 and CXM 2311.

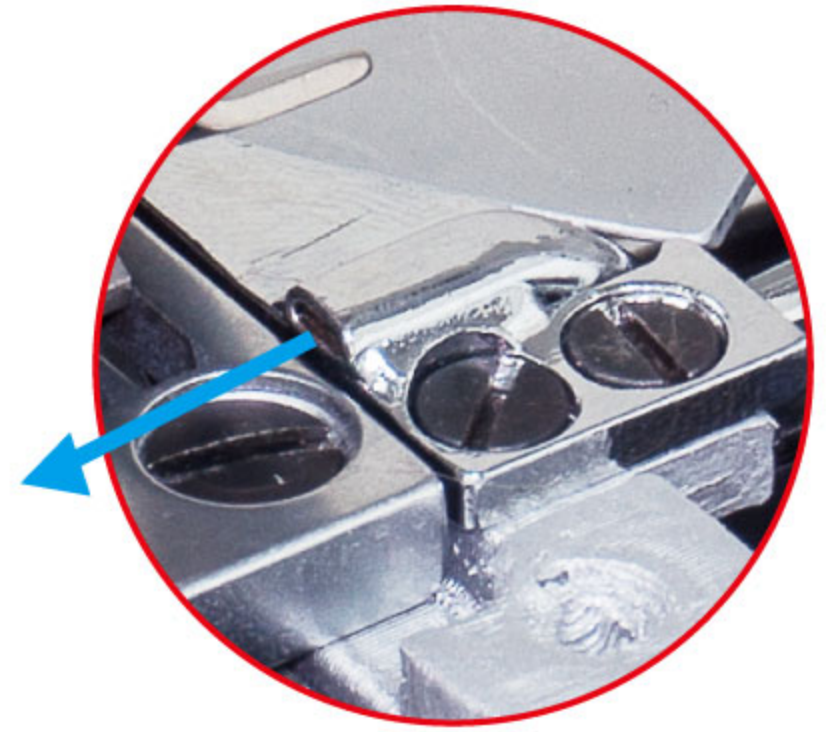
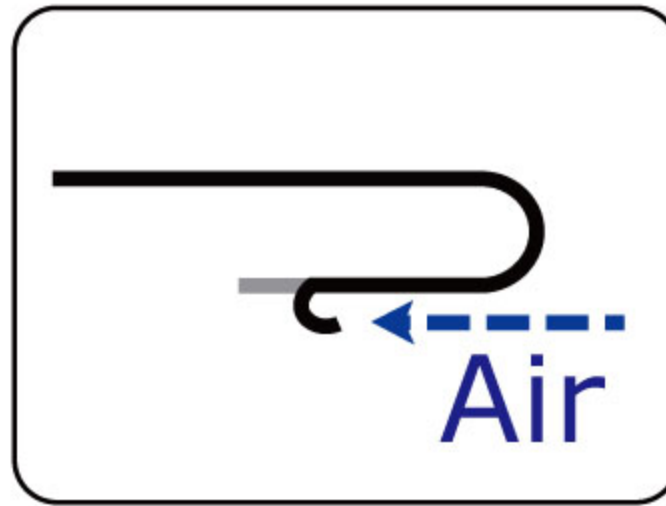

吹氣式布邊防捲裝置（專利）  
Air-Blowing Type Anti-Curling Presser Foot (Patent)UN002

**AF01□**

□ 針位/ Gauge  
A: 240/ B: 248/ C: 356/ D: 364

右切刀修布機型CT/CTD 9085與 CXM 2085 適  
用，CXM 2085 為標準配備。  
The right edge trimmer models, CT/CTD 9085  
and CXM 2085, are  
compatible. And it is standard equipment of  
CXM 2085.

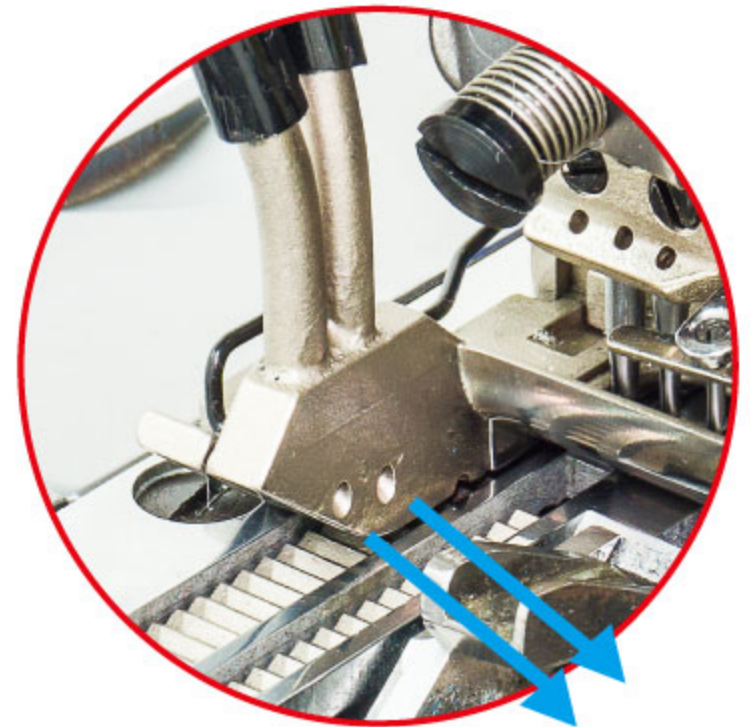
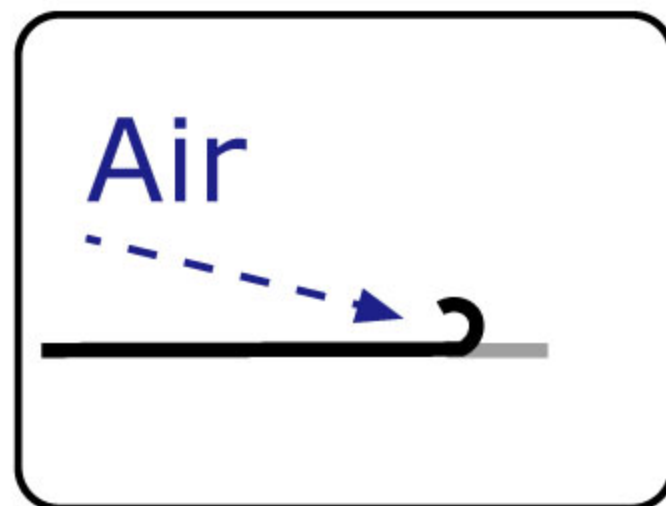

補強帶導模  
Tape Binder

**TB**

TB 002 上送帶導布器  
Top loading tape binder  
TB 003 褲耳車縫  
Belt loop sewing



TB 002



TB 003

步履式壓腳  
Walking Foot

**WF**

對應送具的動作，壓腳可前後滑動，以產生最小壓布力，適用於薄布料  
或易發生壓痕的面料。  
Corresponding to the stroke of feed dog, the presser foot slides back  
and forth to provide the minimum pressure, which is applicable  
to light material or fabrics that are prone to creasing.





**精機機械廠股份有限公司**  
CHING CHI MACHINE CO., LTD  
<http://www.kingtexsewing.com.tw>

公司:新北市板橋區三民路2段31-33號13F  
電話:(02)2961-6865 FAX:(02)2954-6007  
OFFICE:13F., NO.33, Sec2, San Min Rd.Panchiao Dist.,  
New Taipei City, 22069 Taiwan,(R.O.C)  
TEL:(02)2961-6865(REP)  
FAX:(02)2954-6007  
E-Mail:Kingtexs@kingtexs.com.tw

