

○ 機型編號說明

○ MODEL NUMBERING

FTU7011-0-□356M/UFP-FB1

1

2

3

4

5

6

7

機型 / Machine Type:

- FTU70 : 高速直驅上送平台型繙縫機
Direct Drive, Top Feed, Flat Bed Coverstitch Interlock Machine
- FTU72 : 高速直驅上送特厚類平台型繙縫機
Direct Drive, Top Feed, Flat Bed Coverstitch Interlock Machine For Extra Heavy Materials
- FTD70 : 高速直驅平台型繙縫機
Direct Drive Type Flat Bed Coverstitch Interlock Machine
- FTD72 : 高速直驅特厚類平台型繙縫機
Direct Drive Type Flat Bed Coverstitch Interlock Machine For Extra Heavy Materials
- FT70 : 高速平台型繙縫機
Flat Bed Type Coverstitch Interlock Machine
- FT72 : 高速特厚類平台型繙縫機
Flat Bed Coverstitch Interlock Machine For Extra Heavy Materials

用途代號 / Application Code:

- 00-0 : 一般平縫(基本型)
General Plain Seaming(Basic Type)
- 02-0 : 雙鉤針環車縫
Double Chainstitch Tape Attaching
- 03-0 : 上帶滾邊(滾領)車縫
Tape Binding (Collarette Binding)
- 10-0 : 褲袋裏車縫裝置
Pocket Lining Seaming Device
- 11-0 : 下襠車縫
Bottom Hemming (For Thin, Light Weight Materials And Medium Weight Materials)
- 13-0 : 包縫骨壓縫
(倒骨式、包縫骨寬度3.0mm以內)
Overlock Seam Covering (Folding Over, Overlock Seam Width Under 3.0mm)
- 13-1 : 包縫骨壓縫(立骨式、包縫骨寬度3.0mm以內)
Overlock Seam Covering (Flattening Out, Overlock Seam Width Under 3.0mm)
- 13-2 : 包縫骨壓縫(倒骨式、包縫骨寬度6.0mm以內)
Overlock Seam Covering (Folding Over, Overlock Seam Width Under 6.0mm)
- 15-0 : 摺線車縫
Pin Tack Seaming
- 60-0 : 四針六線平台型繙縫機
4-Needle, 6-Thread Flat Bed Type Coverstitch Interlock Machine
- 69-0 : 機械式鬆緊帶或蕾絲鬆緊帶車縫
Mechanical Type Elastic Tape or Lace Attaching (With Right Hand Side Fabric Trimmer)
- 69-2 : 上鬆緊帶或蕾絲車縫, 不具機械式送料裝置
Elastic Or Lace Attaching, But Without Mechanical Metering Device
- 69-3 : 上鬆緊帶滾邊車縫
Elastic or Lace Attaching, With Mechanical Type Metering Device, With Right Hand Side Fabric Trimmer, With Additional Tape Foler

裝飾縫區分碼 / Top Coverstitch Code:

- 0: 無上飾縫
Without Top Coverstitch
- : 有上飾縫
With Top Coverstitch

- 針距 / Needle Distance:
- 40: 40m.m.
 - 48: 48m.m.
 - 52: 52m.m.
 - 56: 56m.m.
 - 60: 60m.m.
 - 64: 64m.m.

- 針數 / Number Of Needle:
- 2: 2針, 2-Needle
 - 3: 3針, 3-Needle
 - 4: 4針, 4-Needle

針板舌之形狀 / Shape Of Needle Plate Tongue:

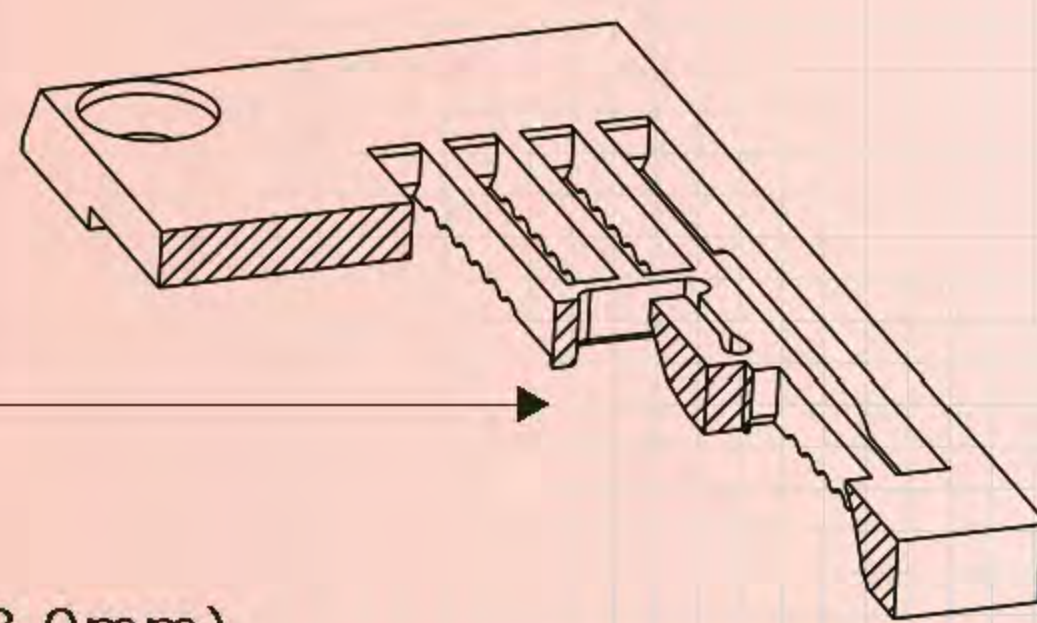
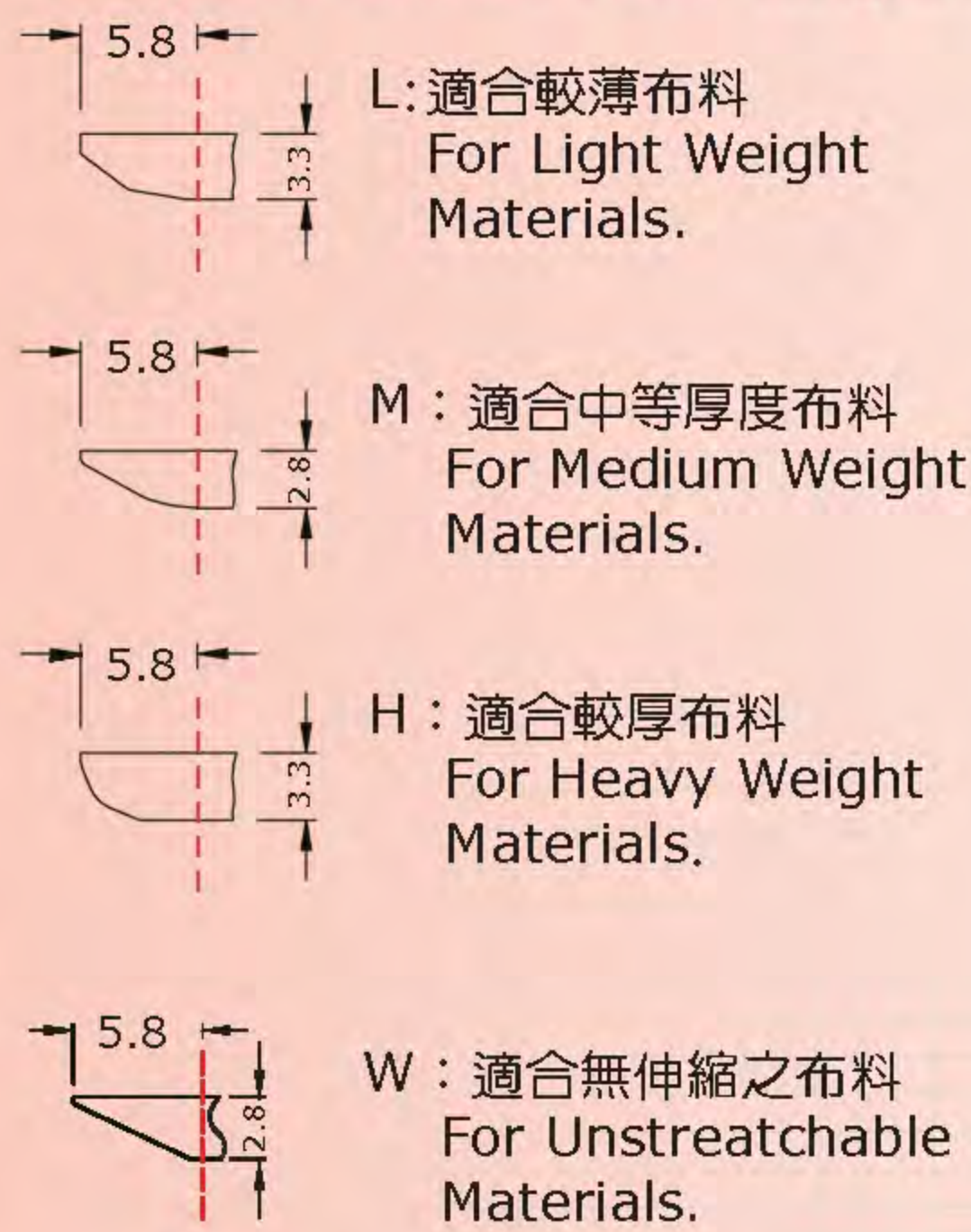

可選擇加裝之裝置 / Optional Device:

- KI002 : 吸風式自動切線裝置
Suction Type Chain Cutter
 - TB002 : 褲面補強裝置
Reinforcing Tape Attaching
 - TB003 : 褲耳車縫
Belt Loop Seaming
 - BOF : 上載式滾邊導模(平台型繙縫機用)
Bed-on Type Folder (For Flatbed Interlock Machine usage)
 - SE005 : 反射式電眼開關組
Reflective Electronic Edge Sensor Set Parts
 - TFU : 上送電動送料裝置
Upper Tape Feeding Device
 - RP005 : 後拉引式拖輪裝置 (FTD7000 & FT7000)
Rear Puller
- FTU7000 series :
- UFP-FB1 : 氣動式自動切線裝置(含UTD7F, STB04)
Pneumatic Type Top And Bottom Thread Trimming System
 - UFE-FB1 : 電動式自動切線裝置(含UTE7E, STC04)
Electric Type Top And Bottom Thread Trimming System
 - TCS01 : 氣動式切帶裝置(平台型繙縫機用)
Pneumatic Type Tape Cutting System (For Flat Bed Interlock Machines)
 - TCS02 : 電動式切帶裝置(平台型繙縫機用)
Electric Type Tape Cutting System (For Flat Bed Interlock Machines)
 - TCS09 : 氣動式切帶裝置(FTU7003上帶滾邊專用)
Pneumatic Type Tape Cutting System (For The Use Of Tape Binding Of FTU7003 Only)
- FTD7000 series :
- TCS03 : 氣動式切帶裝置(FTD7003上帶滾邊專用)
Pneumatic Type Tape Cutting System (For The Use Of Tape Binding Of FTD7003 Only)
 - TCS19 : 氣動式切帶裝置(FTD7069-5上鬆緊帶滾邊車縫專用)
Pneumatic Type Tape Cutting System (For The Use Of Extra Heavy Flat Bed Interlock Of FTD7069-5 Only)
- UFP-B1 : 氣動式自動切線裝置(含UTD7, STD3)
Pneumatic Type Top And Bottom Thread Trimming System
- UFE-B1 : 電動式自動切線裝置(含UTE7, STE3)
Electric Type Top And Bottom Thread Trimming System
- FT7000 series :
- UFP-A1 : 氣動式自動切線裝置(含UTD2, STD)
Pneumatic Type Top And Bottom Thread Trimming System
 - UFE-A1 : 電動式自動切線裝置(含UTE2, STE)
Electric Type Top And Bottom Thread Trimming System
- 69-3A : 上鬆緊帶滾邊車縫, 不具機械式送料裝置
Elastic Tape Or Lace Attaching, With Binding Tape Folder, With Right Hand Side Fabrics Trimmer, Without Mechanical Type Metering Device
 - 69-4 : 變速機鬆緊帶或蕾絲鬆緊帶車縫
Elastic Tape or Lace Attaching By Mechanical Type Metering Device (With Right Hand Side Fabric Trimmer)
 - 69-5 : 變速機上鬆緊帶滾邊車縫
Elastic Tape Feeding By Mechanical Type Metering Device
 - 69-6 : 上鬆緊帶或蕾絲車縫, 電控式送料裝置
Elastic Tape or Lace Attaching Is Driving By Simplified Type Computerized Metering Device
 - 69-6A : 上鬆緊帶或蕾絲車縫, 進階式電控送料裝置
Elastic Tape or Lace Attaching Is Driving By Advance Type Computerized Metering Device With Panel

○ 一般特性
○ GENERAL FEATURES

- 無段按鈕式調整縫目疏密，簡易快捷。特殊設計有效的防止手輪捲線。(圖A)
Simple Push-Button Type Stitch Length Regulator, So The Stitch Length Can Be Adjusted Easily. Special Design Hand Wheel Prevent Sewing Threads From Winding Inside Hand Wheel. (Fig. A)
- 具備省力且靈活的鬆線機構。(圖B)
Equipped with light and soomth thread tension release mechanism. (Fig. B)
- 可微調差動比，運轉中亦可輕易調整差動比例。(圖C)
Easy Micro-Adjustment Of Differential Feeding Ratio; Even During Running Operation. (Fig.C)

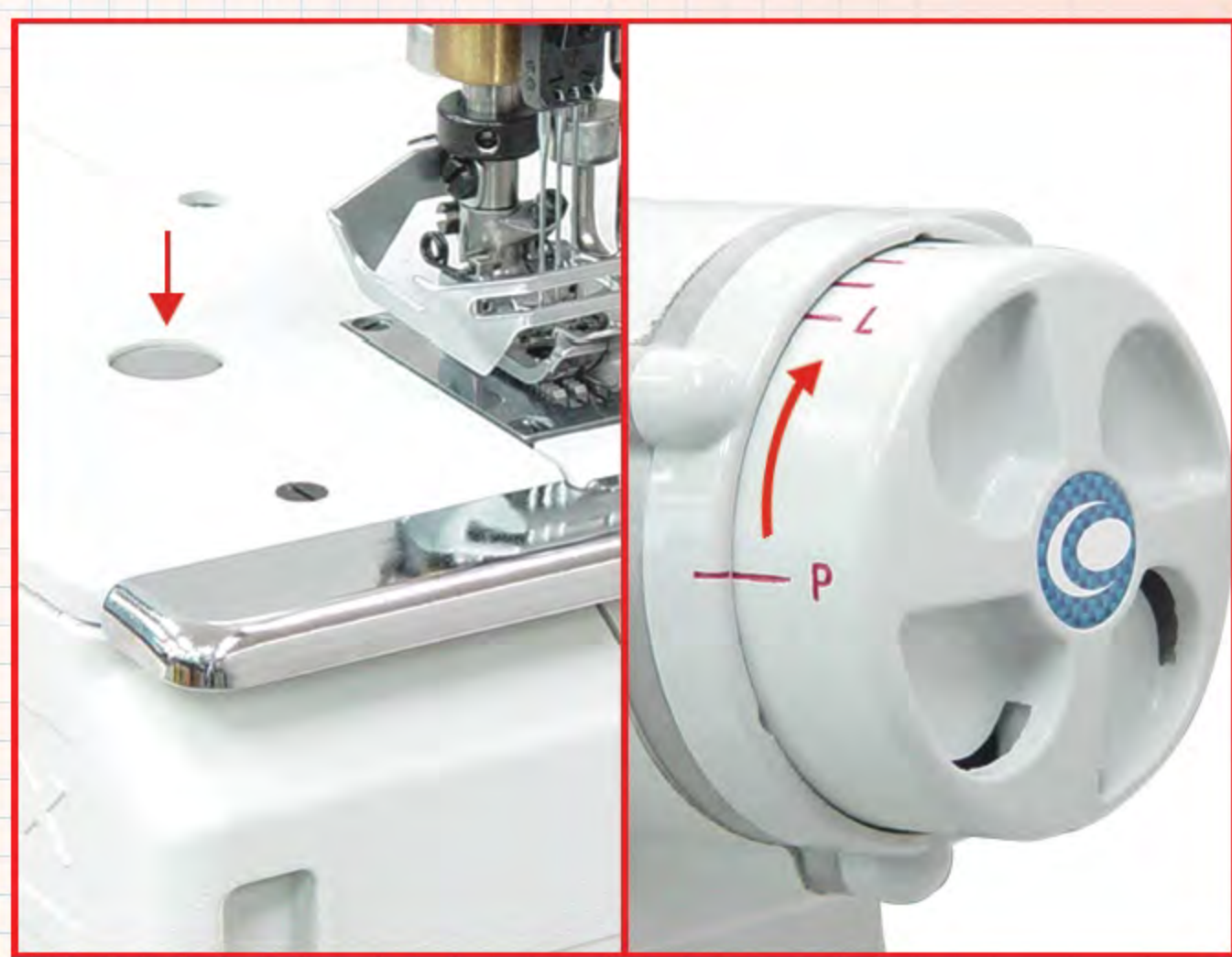

A

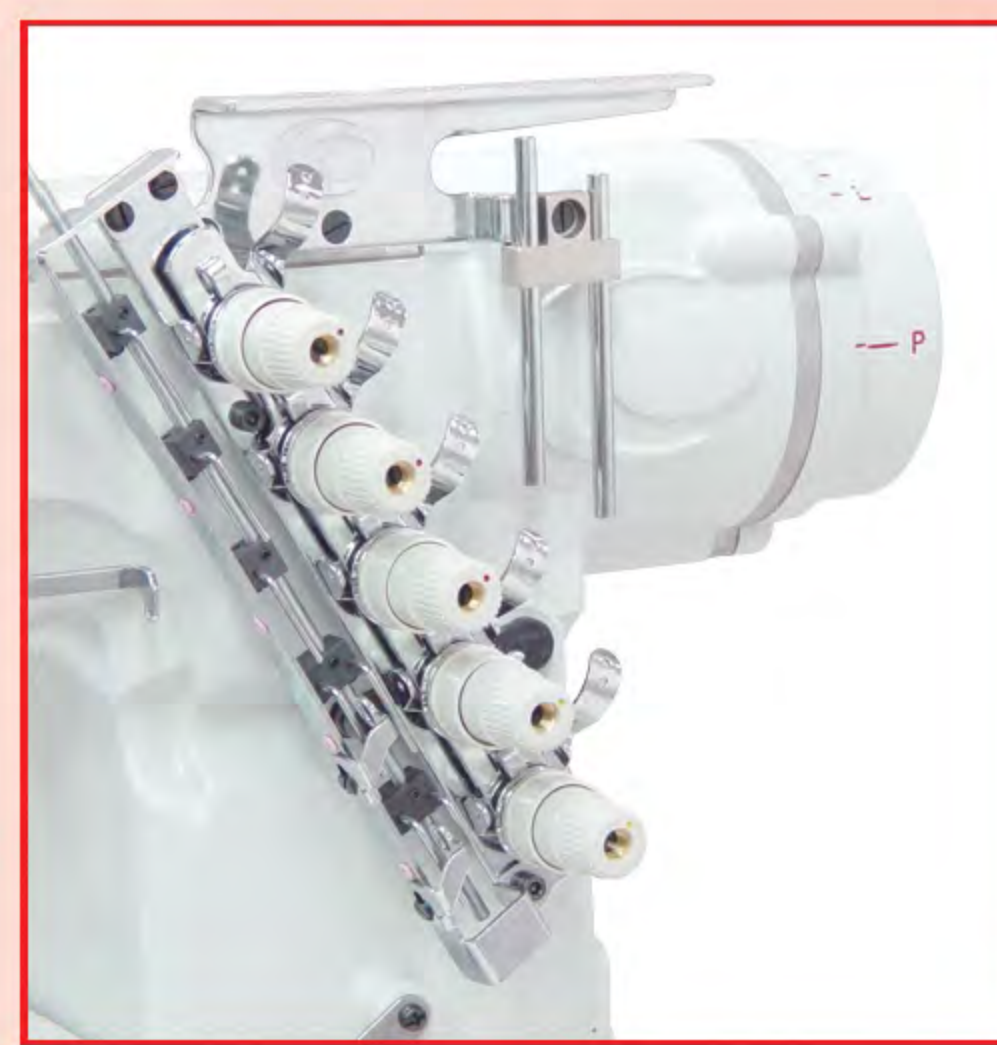

B



C

- 利用上下送布齒送布，不但防止布料的扭曲和波折，還可以有效的防止接縫處密針現象。
By using top and bottom feed dogs, not only can prevent the twisting or curling of the sewing fabrics from happening, but also can prevent the jamming at the cross seam section from happening during the sewing operation.
- 上、下送布齒可以分別調整其差動比，以適應不同布料及縫製效果。
The differential feeding ratio of upper & lower feed dogs can be adjusted individually to adopt different materials or to meet special sewing requirements, such as patterm matching, or sewing slippage materials.

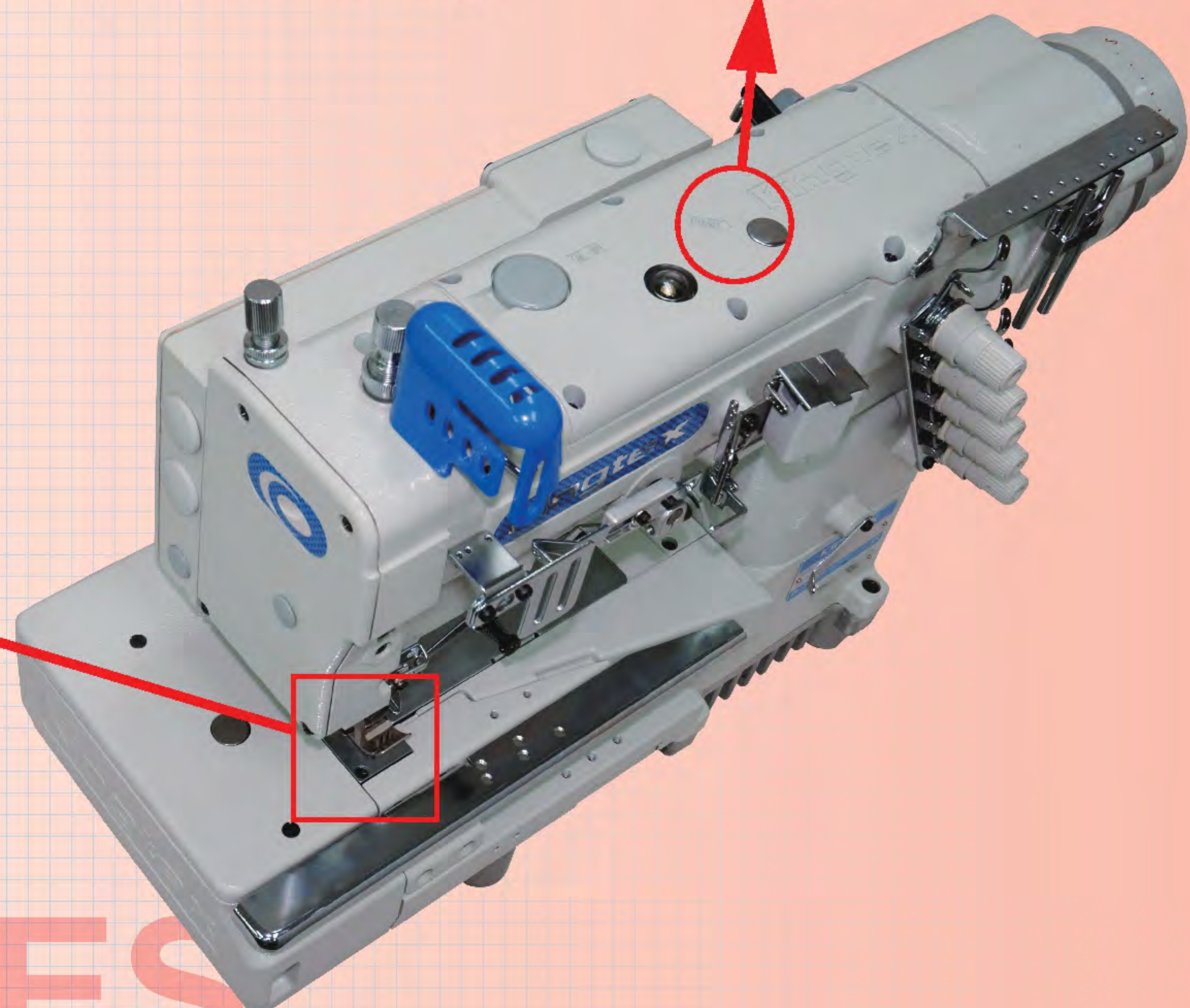



FT 7000-0

- 一般車 (平) 縫
General Plain Seaming
- 針織內衣褲、運動衫、休閒服等；
薄至中厚布料。
Knit underwear, brief,
sports wear--- etc.
Light to medium weight materials.



車下擺導模
Bottom hemming device



BOF: 上載式滾邊導模
Bed-on type tape binder

FT 7200-0

- 特厚類平台式繙縫機
Extra Heavy Flat Bed Interlock
- 針織內衣褲、運動衫、休閒服等；中厚至厚布料。
Knit underwear, brief, sports wear, fleece wear --- etc.
Medium to heavy weight materials.



FT7200-0



FT 7002-0









- 補強帶車縫 (2針4線、雙勾針、雙鏈縫目)
Tape Attaching
(2-Needle, 4-Thread, Double Chain-Stitch)
- 男用針織內褲、T恤、運動裝、休閒服等；
薄至中厚布料。
Men's knit briefs, T-shirts,
polo shirts...etc.
Light to medium weight materials.

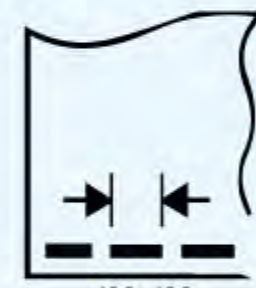

FT 7010-0

- 褲袋裏車縫裝置
Pocket Lining Seaming Device
- 牛仔褲、西褲、等口袋內線；
薄至中厚布料。
For the pocket lining of jeans,
trouser etc.
Light to medium weight materials.

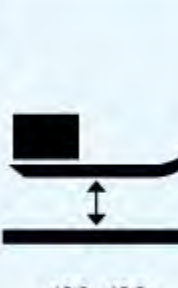

			 m.m.	 m.m.		 m.m.	 UY128 GAS #	 S.P.M.	OPTIONAL DEVICE
FT7000-0-□□□M	2 3	4 5	4.0 / 4.8 4.8 / 5.6 / 6.4						●KI002 ●RP005 ●TB003 ●UFP-A ●UFE-A
FT7000-0-□□□H	2 3	4 5	4.0 / 4.8 4.8 / 5.6 / 6.4	1.4~4.0	1:0.7~1:2	5	#11 ? #14	6000	●TC001 ●TC002 ●TC008 ●TB
FT7000-0-□□□L	2 3	4 5	4.0 / 4.8 4.8 / 5.6 / 6.4						
FT7000-0-□□□W	3	5	5.6 / 6.4						
FT7002-0-264M	2	4	4.8 6.4	1.4~4.0	1:0.7~1:2	5	#11 ? #14	6000	●KI002 ●UFP-A ●UFE-A
FT7010-0-388M	3	7	8.8	1.4~4.0	1:0.7~1:2	5	#12	5500	
FT7200-0-356H FT7200-0-364H	3	5	5.6 6.4	1.4~4.5	1:0.7~1:2	5	#14	5000	

□□□:240, 248, 356, 364

□□□:356, 364



FT 7003-0

- 上帶滾邊(滾領)車縫
Tape Binding(Collarettte Binding).
- 針織、內褲、T恤等。
薄至中厚布料。
Knit underwear, T-shirt, briefs, ---etc.
Light to medium weight materials.



TC003

- 氣動式切帶裝置 (FT7003上帶滾邊專用)
Pneumatic Type Tape Cutting Device
(For The Use Of Tape Binding
Of FT7003 Only)

- 適用蕾絲帶、鬆緊帶、滾條補強帶。
Suitable For Attaching Lace,
Elastic Tape, Binding Tape,
Reinforcement Tape etc.



- 可切斷寬度最大28mm的布料。
Maximum cutting width 28mm .
- 須配合空壓機使用 (5Kg/cm² 或 70PSI)
Must be used together with compressed air. (5Kg/cm² or 70PSI)
- 刀口與壓腳距離5.3mm
The distance between cutting blade and the
rear end of presser foot is 5.3mm



FT 7011-0

- 下襠車縫
(適用於輕、薄、質軟、以及一般中厚布料)
Bottom Hemming
(For Thin, Light Weight Material)
- 男女內衣褲、運動服等針織服裝；薄至中厚布料。
Men's & women's under wears, sports wears,...etc.
Light to medium weight materials.



FT 7060-0

- 4針6線平台式繙縫機 (平縫2裁片之接縫或補強)
4-Needle 6-Thread Flat Bed Interlock
(Plain Seaming, Closing Crotch Of Briefs Or Seam
Reinforcing)
- 男女內衣褲；一般薄布料。
Men's & women's underwears, sports wears,...etc.
Thin or Light to medium weight materials.



裁片導模
Fabric Guide

								OPTIONAL DEVICE
			m.m.	m.m.		m.m.	UV128GAS S.P.M.	
FT7003-0-232M	2	4	3.2					
FT7003-0-240M	2	4	4.0				#11	●TC001
FT7003-0-248M	2	4	4.8	1.4~4.0	1:0.7~1:2	5	?	●TC002
FT7003-0-356M	3	5	5.6				#14	●TC003
FT7003-0-364M	3	5	6.4					●TC009
FT7011-0-□□□M	2	4	4.0 4.8	1.4~4.0	1:0.7~1:2	5	#11	●UFP-A
FT7011-0-□□□M	3	5	5.6 6.4					●UFE-A
FT7060-0-4□□M	4	6	5.2 5.6 6.0 6.4	1.4~4.0	1:0.7~1:2	5	MY1014B #10	●UFP-A
FT7060-0-464H	4	6	6.4					●KI002

□□□:240, 248, 356, 364

□□:52, 56, 60, 64



FT 7013-0

- 包縫骨壓縫 (倒骨式、包縫骨寬度3.0m.m.以內)
Overlock Seam Covering
(Folding Over, Overlock Seam Width Under 3.0m.m.)
- 適用於針織內衣、T恤、運動服等；薄至中厚布料。
Knit underwear, brief, sports wear--- etc.
Light to medium weight materials.



13-0:包縫骨壓縫裝置(倒骨式)
Seam Coverlock Attachment
(Folding Over)



FT 7013-1

- 包縫骨壓縫 (立骨式、包縫骨寬度3.0m.m.以內)
Overlock Seam Covering
(Flattening Out, Overlock Seam Width Under 3.0m.m.)
- 適用於針織內衣、T恤、運動服等；薄至中厚布料。
Knit underwear, brief, sports wear--- etc.
Light to medium weight materials.



13-1:包縫骨壓縫裝置(立骨式)
Seam Coverlock Attachment
(Flattening Out)



FT 7013-2

- 包縫骨壓縫 (倒骨式、包縫骨寬度6.0m.m.以內)
Overlock Seam Covering
(Folding Over, Overlock Seam Width Under 6.0m.m.)
- 適用於針織內衣、T恤、運動服等；薄至中厚布料。
Knit underwear, brief, sports wear--- etc.
Light to medium weight materials.



13-2:包縫骨壓縫裝置(倒骨式)
Seam Coverlock Attachment
(Folding Over)

FT 7015

- 摺線車縫
Pintuck Seaming
- 適用於運動服、牛仔或其他服飾之凸面摺線條車縫。
Suitable for sportswear, jeans or on other
desired clothes.



							UV128GAS 		OPTIONAL DEVICE
			m.m.	m.m.		m.m.		S.P.M.	
FT7013-□-240M	2	4	4.0						
FT7013-□-248M	2	4	4.8						
FT7013-□-348M	3	5	4.8	1.4~4.0	1:0.7~1:2	5	#11	6000	●UFP-A ●UFE-A
FT7013-□-356M	3	5	5.6						
FT7013-□-364M	3	5	6.4						
FT7015-0-232M	2	3	3.2	1.4~4.0	1:0.7~1:2	5	#11	6000	

□:0, 1, 2



FT 7069-0

- 上鬆緊帶或蕾絲車縫 (適用於輕、薄、質軟及一般中厚布料)
Elastic Or Lace Attaching
(With Right Hand Side Fabric Trimmer).
- 女用內衣、內褲；薄至中厚布料。
最大適用寬度：蕾絲帶：80m.m.、鬆緊帶：25m.m.
Women's underwear, briefs.
Light to medium weight materials.
Max.applicable width: Lace:80m.m.
Elastic tape:25m.m.



69-0:右切刀修布裝置
Right Hand Fabric Trimmer

FT 7069-1

- 上鬆緊帶或蕾絲車縫,不具有右切刀修布裝置 (適用於輕、薄、質軟及一般中厚布料)
Elastic Or Lace Attaching, With Mechanical Metering Device, But Without Right Hand Knife
(With Right Hand Side Fabric Trimmer)

- 女用內衣、內褲；薄至中厚布料。
最大適用寬度：蕾絲帶：80m.m.、鬆緊帶：25m.m.
Women's underwear, briefs.
Light to medium weight materials.
Max.applicable width: Lace:80m.m.
Elastic tape:25m.m.



69-1



FT 7069-2

- 上鬆緊帶或蕾絲車縫,不具機械式送料裝置 (適用於輕、薄、質軟及一般中厚布料)
Elastic Or Lace Attaching, With Right Hand Knife, But Without Mechanical Metering Device
(With Right Hand Side Fabric Trimmer).

- 女用內衣、內褲；薄至中厚布料。
最大適用寬度：蕾絲帶：80m.m.、鬆緊帶：25m.m.
Women's underwear, briefs.
Light to medium weight materials.
Max.applicable width: Lace:80m.m. Elastic tape:25m.m.



69-2:右切刀修布裝置
Right Hand Fabric Trimmer











FT 7069-3

- 上鬆緊帶滾邊車縫
Elastic Tape Attaching, With Mechanical Type Metering Device, With Right Hand Side Fabric Trimmer, With Additional Tape Foler.

- 女用內衣、內褲；薄至中厚布料。
Women's underwear, briefs.
Light to medium weight materials.



69-3

			 m.m.	 m.m.		 m.m.	UY128GAS  #	 S.P.M.	OPTIONAL DEVICE
FT7069-0-232M	2	4	3.2						
FT7069-0-240M	2	4	4.0						
FT7069-0-248M	2	4	4.8	1.4~4.0	1:0.7~1:2	5	#11	4500	
FT7069-0-356M	3	5	5.6						
FT7069-0-364M	3	5	6.4						
FT7069-1-356M	3	5	5.6	1.4~4.0	1:0.7~1:2	5	#11	4500	●TC004
FT7069-1-364M	3	5	6.4						●TC005
FT7069-2-232M	2	4	3.2						●TC009
FT7069-2-240M	2	4	4.0						●SE005
FT7069-2-248M	2	4	4.8	1.4~4.0	1:0.7~1:2	5	#11	4500	
FT7069-2-356M	3	5	5.6						
FT7069-2-364M	3	5	6.4						
FT7069-3-232M	2	4	3.2	1.4~4.0	1:0.7~1:2	5	#11	4500	

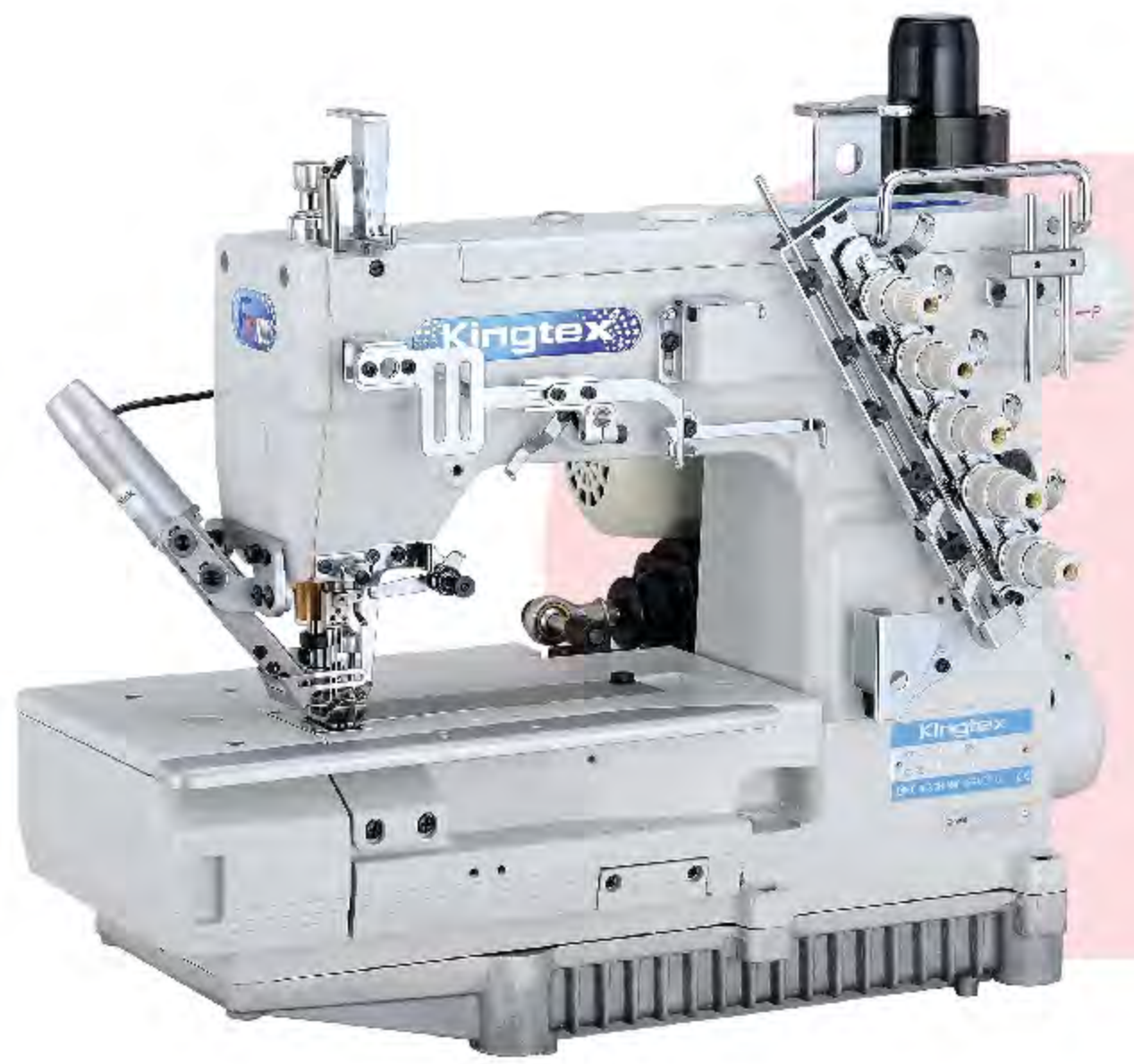

UFE-A

- 電動式自動切線裝置(平台型繙縫機用)
Electric Type Thread Trimming System
(For Flat Bed Interlock Machines)

特點 Feature

- 本裝置可適用於所有 FT 系列機種，但不單獨供應此裝置。
Suitable for all FT series machines, but only supply together with machine head.
- 須配合伺服馬達使用或電子馬達
Should be used together with AC servo motor or E.C.motor .



WPH: 撥線裝置
Wiper



UTE2: 電動切底線裝置
Electric Under Bed Thread Trimmer



UTE2: 電動切上飾線裝置
Electric Top Cover Thread Trimmer

UFE - A1

① ② ③ ④

① 自動切線裝置代號	① Under bed thread trimmer device
② 機型 C:方筒型繙縫機 F:平台型繙縫機	② Model C:Cylinder bed interlock F:Flat bed interlock
③ 動力 P:氣動式 E:電動式	③ Power P:Pneumatic Type E:Electric Type
④ 裝置組合代號	④ Combination of devices

MODEL	電動式自動切線裝置 Electric Type Thread Trimming System			
	(UTE2) 切底線裝置 Under Bed Thread Trimmer	(STE) 切上飾線裝置 Top Cover Thread Trimmer	(WPH) 撥線裝置 Wiper	壓腳提昇裝置 Presser foot Lifter
UFE-A1	●	●		●
UFE-A2	●		●	●
UFE-A3	●	●	●*	●
UFE-A4	●			●

* 包裝於附件箱中 Packed in the accessories box



電動式壓腳提昇裝置
Electric Presser foot Lifter



UFP-A

- 氣動式自動切線裝置(平台型繙縫機用)
Pneumatic Type Thread Trimming System
(For Flat Bed Interlock Machines)

特點 Feature

- 本裝置可適用於所有 FT 系列機種，但不單獨供應此裝置。
Suitable for all FT series machines, but only supply together with machine head.
- 須配合伺服馬達使用或電子馬達
Should be used together with AC servo motor or E.C.motor.
- 須配合空壓機使用，(5kg/cm² 或 70PSI)
Compressed air is required(5kg/cm² 或 70PSI)



WPC: 撥線裝置
Wiper



UTD2: 電動式切底線裝置
Electric Under Bed Thread Trimmer



STD: 氣動式切上飾線裝置
Pneumatic Top Covering
Thread Trimmer

UFP - A1

① ② ③ ④

① 自動切線裝置代號	① Under bed thread trimmer device
② 機型 C:方筒型繙縫機 F:平台型繙縫機	② Model C:Cylinder bed interlock F:Flat bed interlock
③ 動力 P:氣動式 E:電動式	③ Power P:Pneumatic Type E:Electric Type
④ 裝置組合代號	④ Combination of devices

MODEL	氣動式自動切線裝置 Pneumatic Type Thread Trimming System					備註 Comment
	(UTD2) 切底線裝置 Under Bed Thread Trimmer	(UTD4) 切底線裝置 Under Bed Thread Trimmer	(STD) 切上飾線裝置 Top Cover Thread Trimmer	(WPH) 撥線裝置 Wiper	壓腳提昇裝置 Presser foot Lifter	
UFP-A1	●		●		●	
UFP-A2	●			●	●	
UFP-A3	●		●	●*	●	
UFP-A4	●				●	
UFP-AA		●	●		●	FT7060用 For FT7060

* 包裝於附件箱中 Packed in the accessories box



氣動式壓腳提昇裝置
Pneumatic Presser foot Lifter

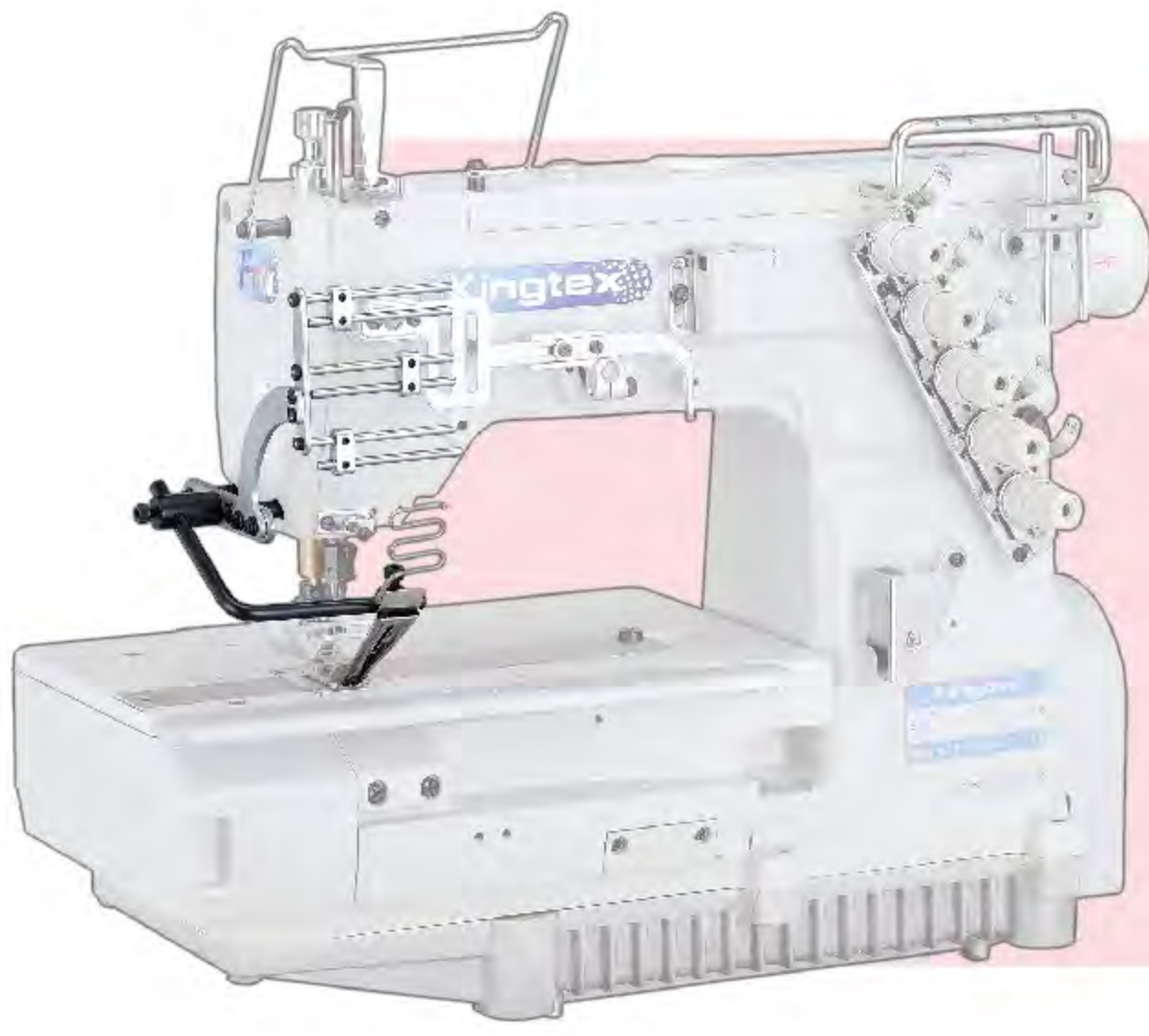

TB002

- 褲面補強帶裝置
Reinforcins Tape Attaching
- 利用已裁好之等寬布條連續快速車縫。
Using Pre-Cut Strip Tapes, Fast Continuous Seaming Can Be Achieved Easily.
- 方便易調整支架, 適合各式各樣車縫
Using Convenient Adjustable Bracket, Suitable For Different Kinds Of Sewing Requirement.



TB003

- 褲耳車縫
Belt-Loop Seaming
- 將預裁等寬之滾條快速連續縫製褲耳。
Can Sew Pre-Cut Tapes Fast And Easily Into Belt Loop.



KI002

- 下吸式自動切線裝置
Pneumatic Type Under Bed Suction Chain Cutter.
- 適用大部分 FT 系列機種。
Suitable For Most Of FT Series Of Machine.



TC001

- 氣動式切帶裝置(平台型繃縫機用)
Pneumatic Type Tape Cutting Device (For Flat Bed Interlock Machines).
- 適用蕾絲帶、鬆緊帶、滾條補強帶。
Suitable For Attaching Lace, Elastic Tape, Binding Tape, Reinforcement Tape etc.
- 刀口與壓腳距離31.9mm
The distance between cutting blade and the rear end of presser foot is 31.9mm.





TC002

- 電動式切線裝置 (平台型繙縫機用)
Electric Type Tape Cutting Device
(For Flat Bed Interlock Machines).
- 適用蕾絲帶、鬆緊帶、滾條補強帶。
Suitable For Attaching Lace, Elastic Tape, Binding Tape, Reinforcement Tape etc.
- 可切斷寬度最大32mm的布料。
Maximum cutting width 32mm .
- 刀口與壓腳距離31.9mm。
The distance between cutting blade and the rear end of presser foot is 31.9mm.



TC004

- 氣動式切帶裝置
(FT7069-0~FT7069-5上鬆緊帶或蕾絲車縫專用)
Pneumatic Type Tape Cutting Device
(For The Use Of Cutting Elastic Tape Or Lace Of FT7069-0 ~ FT7069-5 Only).
- 適用蕾絲帶、鬆緊帶、滾條補強帶。
Suitable For Attaching Lace, Elastic Tape, Binding Tape, Reinforcement Tape etc.
- 可切斷寬度最大32mm的布料。
Maximum cutting width 32mm .
- 須配合空壓機使用 (5Kg/cm² 或 70PSI)
Must be used together with compressed air. (5Kg/cm² or 70PSI)
- 刀口與壓腳距離31.9mm。
The distance between cutting blade and the rear end of presser foot is 31.9mm.



TC005

- 電動式切線裝置 (FT7069-0 ~ FT7069-5上鬆緊帶或蕾絲車縫專用)
Electric Type Tape Cutting Device
(For The Use Of Cutting Elastic Tape Or Lace Of FT7069-0 ~ FT7069-5 Only).
- 適用蕾絲帶、鬆緊帶、滾條補強帶。
Suitable For Attaching Lace, Elastic Tape, Binding Tape, Reinforcement Tape etc.
- 可切斷寬度最大32mm的布料。
Maximum cutting width 32mm .
- 刀口與壓腳距離31.9mm
The distance between cutting blade and the rear end of presser foot is 31.9mm.



TC009

- 氣動式切帶裝置
(FT7003, FT7069-0, FT7069-2, FT7069-4, FT7069-6 用)
Pneumatic Type Tape Cutting Device
(For FT7003, FT7069-0, FT7069-2, FT7069-4, FT7069-6 Only).
- 適用蕾絲帶、鬆緊帶、滾條補強帶。
Suitable For Attaching Lace, Elastic Tape, Binding Tape, Reinforcement Tape etc.
- 可切斷寬度最大28mm的布料。
Maximum cutting width 28mm .
- 須配合空壓機使用 (5Kg/cm² 或 70PSI)
Must be used together with compressed air. (5Kg/cm² or 70PSI)
- 刀口與壓腳距離12.3mm
The distance between cutting blade and the rear end of presser foot is 12.3mm.





FTD 7000-0

- 一般車 (平) 縫
General Plain Seaming.
- 一般針織內衣褲、運動衫、休閒服等；
薄至中厚布料。
Knit underwear, brief, sports wear--- etc.
Light to medium weight materials.



車下擺導模
Bottom hemming device



BOF: 上載式滾邊導模
Bed-on type tape binder

FTD 7200-0

- 特厚類平台式繙縫機
Extra Heavy Flat Bed Interlock.
- 一般針織內衣褲、運動衫、休閒服等；中厚至厚布料。
Knit underwear, brief, sports wear, fleece wear --- etc.
Medium to heavy weight materials.



FTD7200-0

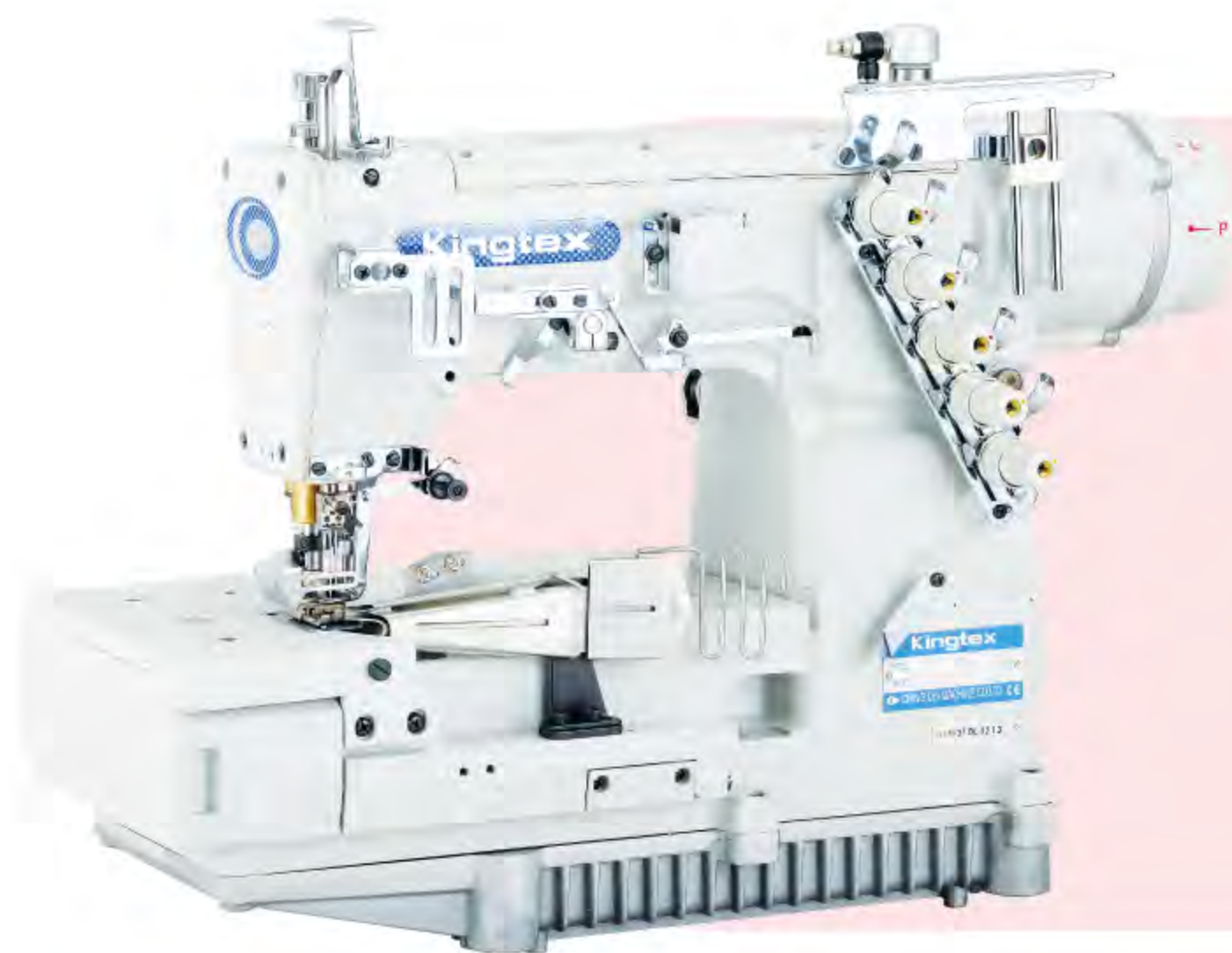

FTD 7003-0

- 上帶滾邊(滾領)車縫
Tape Binding(Collarettte Binding).
- 針織、內褲、T恤等。
薄至中厚布料。
Knit underwear, T-shirt, briefs,---etc.
Light to medium weight materials.











FTD 7060-0

- 4針6線平台式繙縫機 (平縫2裁片之接縫或補強)
4-Needle 6-Thread Flat Bed Interlock
(Plain Seaming, Closing Crotch Of Briefs Or Seam Reinforcing).
- 男女內衣褲；一般薄布料。
Men's & women's underwears, sports wears,---etc.
Thin, Light to medium weight materials.

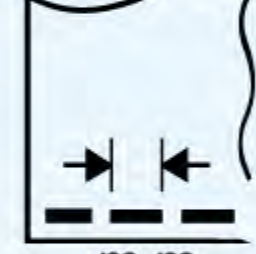

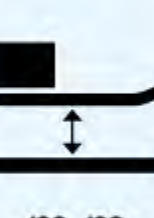
裁片導模
Fabric Guide

			 m.m.	 m.m.		 m.m.	UY128GAS 	 S.P.M.	OPTIONAL DEVICE
FTD7000-0-□□□M	2 3	4 5	4.0 / 4.8 4.8 / 5.6 / 6.4						
FTD7000-0-□□□H	2 3	4 5	4.0 / 4.8 4.8 / 5.6 / 6.4						●UFP-B ●UFE-B
FTD7000-0-□□□L	2 3	4 5	4.0 / 4.8 4.8 / 5.6 / 6.4	1.4~4.0	1:0.7~1:2	5	#11 ? #14	6000	
FTD7000-0-3□□W	3	5	5.6 / 6.4						
FTD7003-0-□□□M	2 3	4 5	3.2 / 4.0 4.8 / 5.6 / 6.4						●TCS0□
FTD7060-0-□□□M	4	6	5.2 5.6 6.0 6.4	1.4~4.0	1:0.7~1:2	5	MY1014B #10	5000	●UFP-B ●KI002
FTD7060-0-464H	4	6	6.4						
FTD7200-0-3□□H	3	5	5.6 / 6.4	1.4~4.5	1:0.7~1:2	5	#14	5000	●UFP-B ●UFE-B

□□□:240, 248, 356, 364
□□:56, 64

□□□:232, 240, 348, 356, 364
TCS0□:1, 2, 3, 9

□□□:452, 456, 460, 464



FTD 7011-0

- 下襠車縫 (適用於輕、薄、質軟、以及一般中厚布料)
Bottom Hemming (For Thin, Light Weight Material)
- 男女內衣褲、運動服等針織服裝；薄至中厚布料。
Men's & women's under wears, sports wears,...etc.
Light to medium weight materials.



FTD 7013-0

- 包縫骨壓縫 (倒骨式、包縫骨寬度3.0m.m.以內)
Overlock Seam Covering (Folding Over, Overlock Seam Width Under 3.0m.m.)
- 適用於針織內衣、T恤、運動服等；薄至中厚布料。
Knit underwear, brief, sports wear--- etc.
Light to medium weight materials.



13-0:包縫骨壓縫裝置(倒骨式)
Seam Coverlock Attachment (Folding Over)



FTD 7013-1

- 包縫骨壓縫 (立骨式、包縫骨寬度3.0m.m.以內)
Overlock Seam Covering (Flattening Out, Overlock Seam Width Under 3.0m.m.)
- 適用於針織內衣、T恤、運動服等；薄至中厚布料。
Knit underwear, brief, sports wear--- etc.
Light to medium weight materials.











13-1:包縫骨壓縫裝置(立骨式)
Seam Coverlock Attachment (Flattening Out)

FTD 7013-2

- 包縫骨壓縫 (倒骨式、包縫骨寬度6.0m.m.以內)
Overlock Seam Covering (Folding Over, Overlock Seam Width Under 6.0m.m.)
- 適用於針織內衣、T恤、運動服等；薄至中厚布料。
Knit underwear, brief, sports wear--- etc.
Light to medium weight materials.

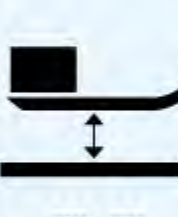

13-2:包縫骨壓縫裝置(倒骨式)
Seam Coverlock Attachment (Folding Over)

			 m.m.	 m.m.		 m.m.	UY128GAS  m.m.	 S.P.M.	OPTIONAL DEVICE
FTD7011-0-240M	2	4	4.0						
FTD7011-0-248M	2	4	4.8	1.4~4.0	1:0.7~1:2	5	#11	6000	●UFP-B ●UFE-B
FTD7011-0-356M	3	5	5.6						
FTD7011-0-364M	3	5	6.4						
FTD7013-□-240M	2	4	4.0						
FTD7013-□-248M	2	4	4.8	1.4~4.0	1:0.7~1:2	5	#11	6000	●UFP-B ●UFE-B
FTD7013-□-348M	3	5	4.8						
FTD7013-□-356M	3	5	5.6						
FTD7013-□-364M	3	5	6.4						

□:0, 1, 2



FTD 7069-4

- 上鬆緊帶或蕾絲車縫, 變速機送料裝置
(適用於輕、薄、質軟及一般中厚布料)
Elastic Tape or Lace Attaching Is Driving By Mechanical Type Metering Device.
(Suitable For Light, Thin, Soft Fabrics and also suitable for Light To Medium Weight Fabrics).
- 女用內衣、內褲; 薄至中厚布料。
最大適用寬度: 蕾絲帶: 80m.m.、鬆緊帶: 25m.m.
Women's underwear, briefs.
Light to medium weight materials.
Max.applicable width: Lace:80m.m. Elastic tape:25m.m.

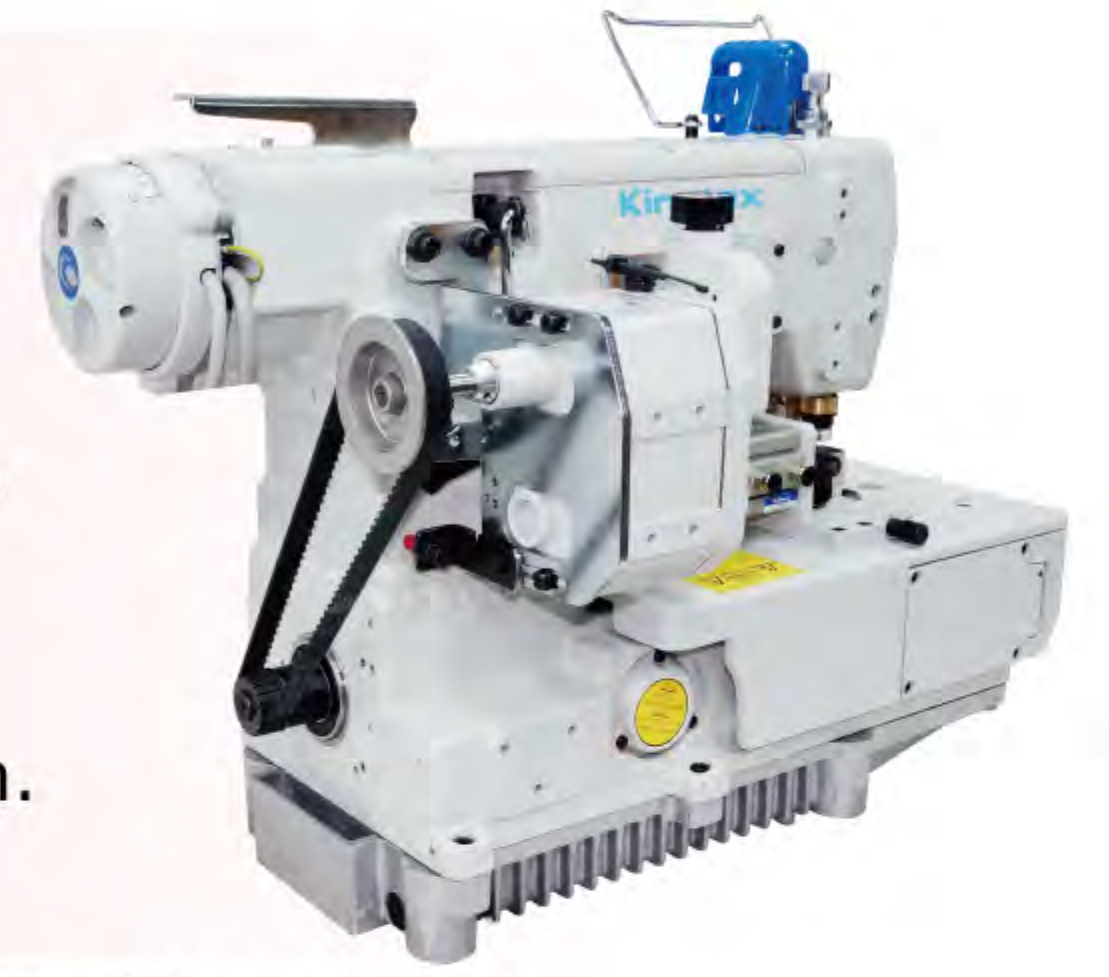

FTD 7069-5

- 變速機上鬆緊帶滾邊車縫
Elastic Tape Binding By Mechanical Type Metering Device.
- 女用內衣、內褲; 薄至中厚布料。
Women's underwear, briefs.
Light to medium weight materials.



FTD



FTD 7069-6

- 上鬆緊帶或蕾絲車縫, 電控式送料裝置
Elastic Tape or Lace Attaching Is Driving By Simple Type Computerized Metering Device.

7069-6A

- 上鬆緊帶或蕾絲車縫, 進階式電控送料裝置
Elastic Tape or Lace Attaching Is Driving By Advance Type Computerized Metering Device With operation Panel.
- 適用於輕、薄、質軟及一般中厚布料
Suitable For Light, Thin, Soft Fabrics and also suitable for Light To Medium Weight Fabrics.
- 女用內衣、內褲; 薄至中厚布料。
最大適用寬度: 蕾絲帶: 80m.m.、鬆緊帶: 25m.m.
Women's underwear, briefs.
Light to medium weight materials.
Max.applicable width: Lace:80m.m. Elastic tape:25m.m.



FTD7069-6A

							UY128 GAS			OPTIONAL DEVICE
			m.m.	m.m.		m.m.			S.P.M.	
FTD7069-□-232M	2	4	3.2							
FTD7069-□-240M	2	4	4.0							
FTD7069-□-248M	2	4	4.8							
FTD7069-□-356M	3	5	5.6							●TCS04
FTD7069-□-364M	3	5	6.4							●TCS05
FTD7069-□-232L	2	4	3.2	1.4~4.0	1:0.7~1:2	5	#11	4500		●TCS09
FTD7069-□-240L	2	4	4.0							●SE005
FTD7069-□-356L	3	5	5.6							
FTD7069-□-364L	3	5	6.4							
FTD7069-5-232M	2	4	3.2	1.4~4.0	1:0.7~1:2	5	#11	4500		●TCS04 ●TCS05 ●TCS19 ●SE005

□:4, 6, 6A

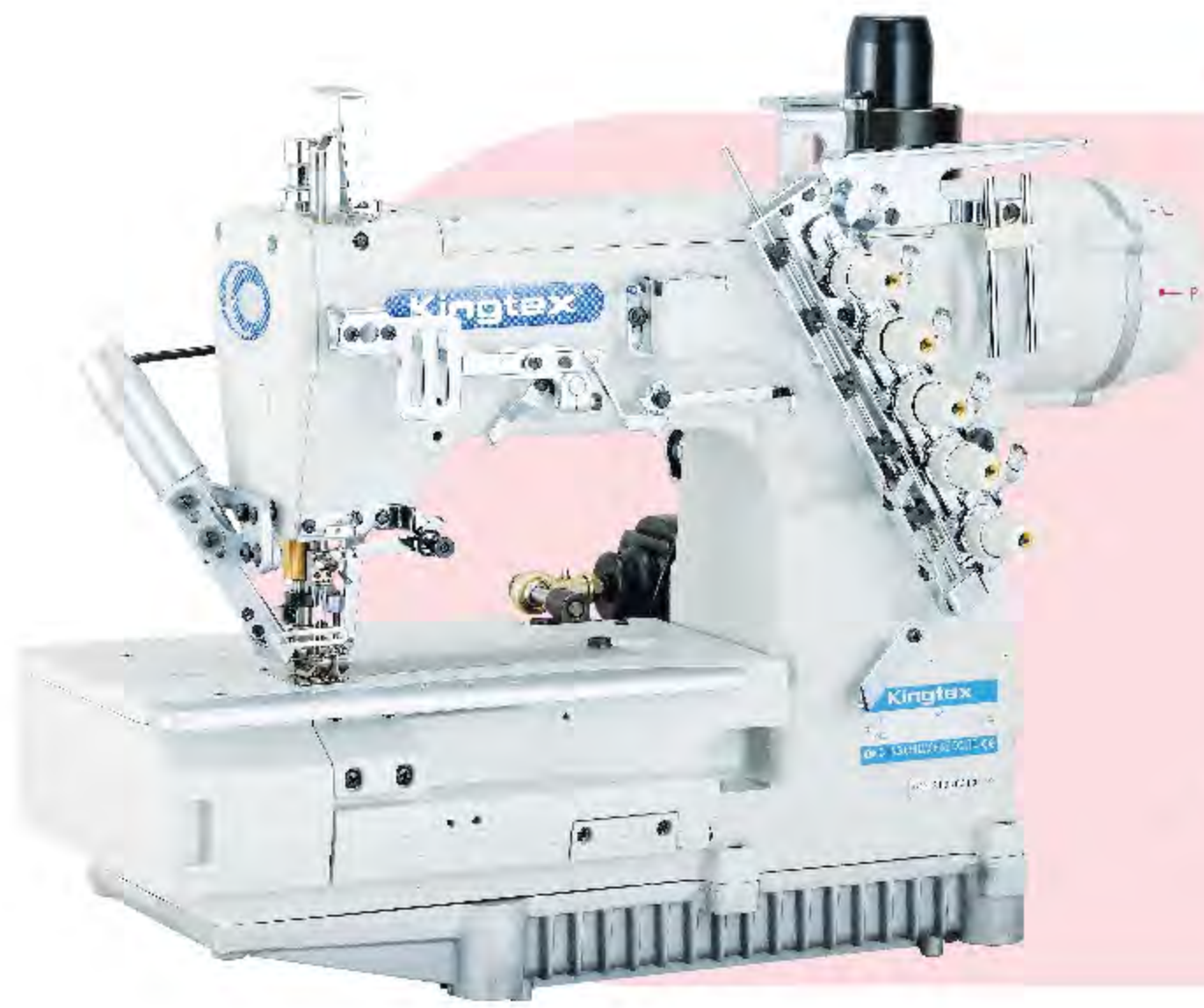

UFE-B

- 電動式自動切線裝置(平台型繙縫機用)
Electric Type Thread Trimming System
(For Flat Bed Interlock Machines)

特點 Feature

- 本裝置可適用於所有 FTD 系列機種，但不單獨供應此裝置。
Suitable for all FTD series machines, but only supply together with machine head.



WPH: 撥線裝置
Wiper



UTE07: 電動切底線裝置
Electric Under Bed Thread Trimmer



STE03: 電動切上飾線裝置
Electric Top Cover Thread Trimmer

UFE - B1

① ② ③ ④

① 自動切線裝置代號	① Under bed thread trimmer device
② 機型 C:方筒型繙縫機 F:平台型繙縫機	② Model C:Cylinder bed interlock F:Flat bed interlock
③ 動力 P:氣動式 E:電動式	③ Power P:Pneumatic Type E:Electric Type
④ 裝置組合代號	④ Combination of devices

MODEL	電動式自動切線裝置 Electric Type Thread Trimming System			
	(UTE07) 切底線裝置 Under Bed Thread Trimmer	(STE03) 切上飾線裝置 Top Cover Thread Trimmer	(WPH) 撥線裝置 Wiper	壓腳提昇裝置 Presser foot Lifter
UFE-B1	●	●		●
UFE-B2	●		●	●
UFE-B3	●	●	●*	●
UFE-B4	●			●

* 包裝於附件箱中 Packed in the accessories box



電動式壓腳提昇裝置
Electric Presser foot Lifter

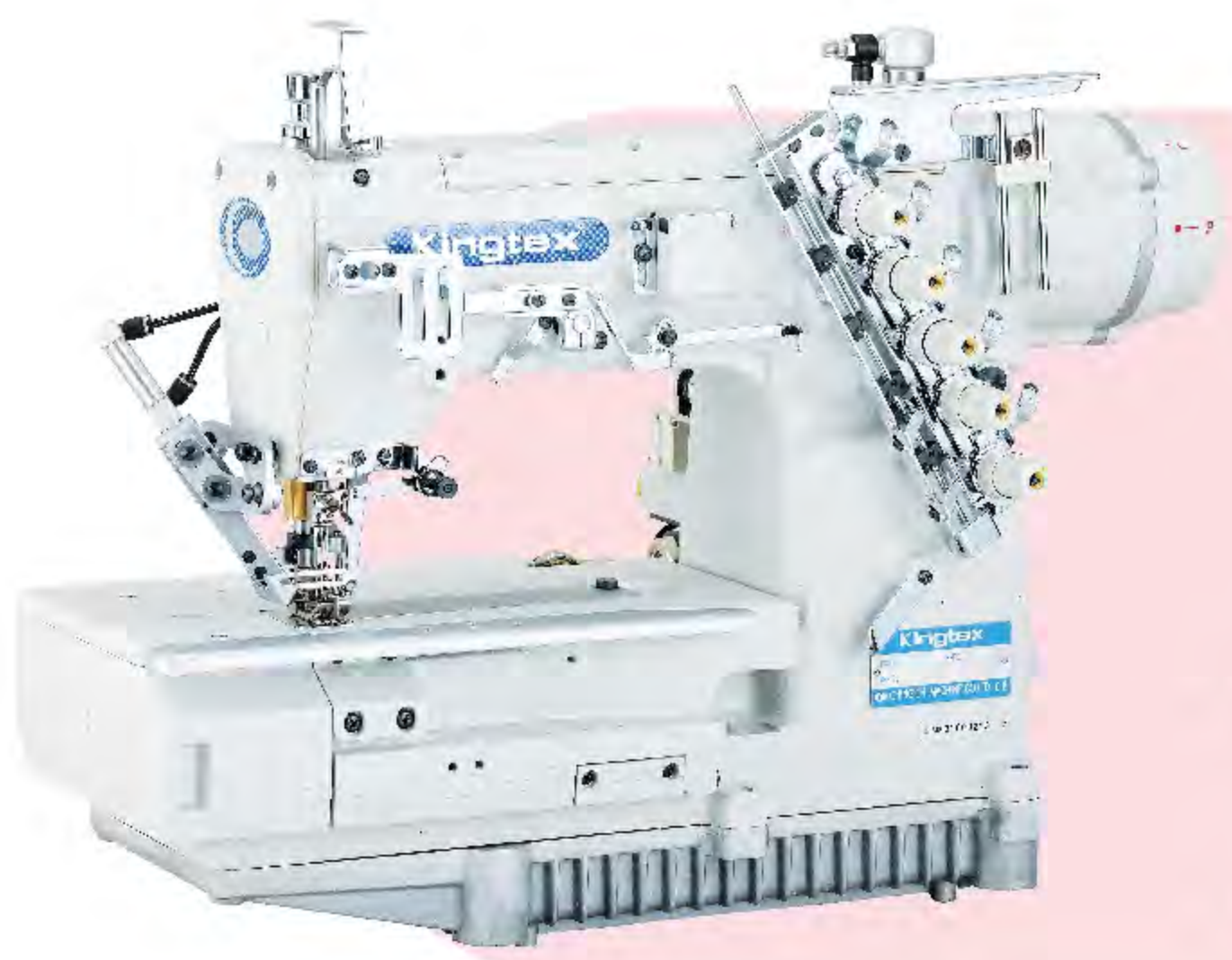

UFP-B

- 氣動式自動切線裝置(平台型繙縫機用)
Pneumatic Type Thread Trimming System
(For Flat Bed Interlock Machines)

特點 Feature

- 本裝置可適用於所有 FTD 系列機種，但不單獨供應此裝置。
Suitable for all FTD series machines, but only supply together with machine head.
- 須配合空壓機使用，(5kg/cm² 或 70PSI)
Compressed air is required(5kg/cm² 或 70PSI)



UTD07: 電動式切底線裝置
Electric Under Bed Thread Trimmer



STD03: 氣動式切上飾線裝置
Pneumatic Top Covering Thread Trimmer

UFP - B1

① ② ③ ④

① 自動切線裝置代號	① Under bed thread trimmer device
② 機型 C:方筒型繙縫機 F:平台型繙縫機	② Model C:Cylinder bed interlock F:Flat bed interlock
③ 動力 P:氣動式 E:電動式	③ Power P:Pneumatic Type E:Electric Type
④ 裝置組合代號	④ Combination of devices

MODEL	氣動式自動切線裝置 Pneumatic Type Thread Trimming System					
	(UTD07) 切底線裝置 Under Bed Thread Trimmer	(UTD07B) 切底線裝置 Under Bed Thread Trimmer	(STD03) 切上飾線裝置 Top Cover Thread Trimmer	(WPC02) 撥線裝置 Wiper	壓腳提昇裝置 Presser foot Lifter	備註 Comment
UFP-B1	●		●		●	
UFP-B2	●			●	●	
UFP-B3	●		●	●*	●	
UFP-B4	●				●	
UFP-BA		●	●		●	FTD7060用 For FTD7060

* 包裝於附件箱中 Packed in the accessories box



WPC02: 撥線裝置
Wiper

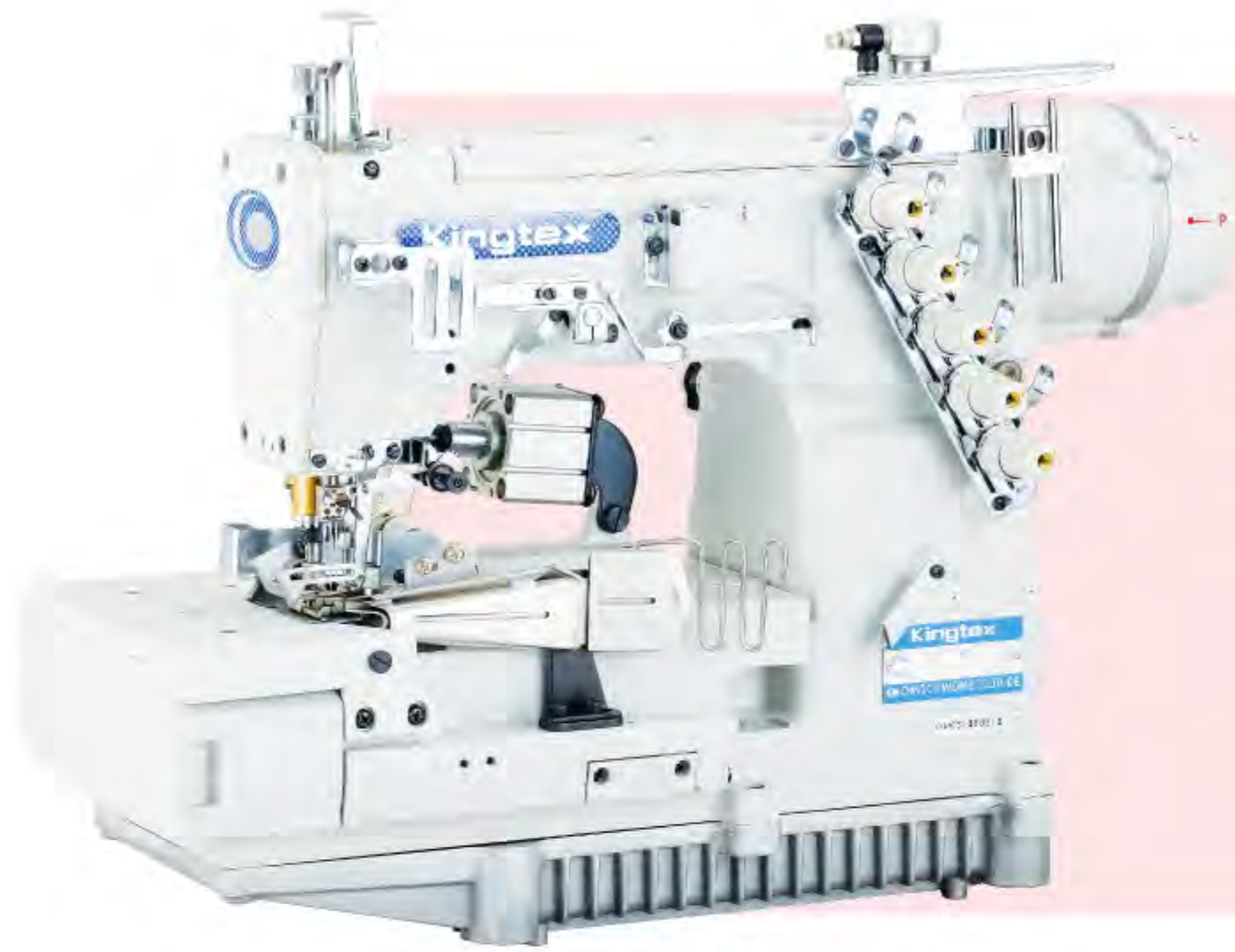

TCS01

- 氣動式切帶裝置 (FTD7003, FTU7003上帶滾邊用)
Pneumatic Type Tape Cutting Device
(For The Use Of Tape Binding Of FTD7003, FTU7003 Only).
- 適用蕾絲帶、鬆緊帶、滾條補強帶。
Suitable For Attaching Lace, Elastic Tape, Binding Tape, Reinforcement Tape etc.
- 可切斷寬度最大32mm的布料。
Maximum cutting width 32mm .
- 須配合空壓機使用 (5Kg/cm² 或 70PSI)
Must be used together with compressed air. (5Kg/cm² or 70PSI)
- 刀口與壓腳距離31.9mm。
The distance between cutting blade and the rear end of presser foot is 31.9mm.

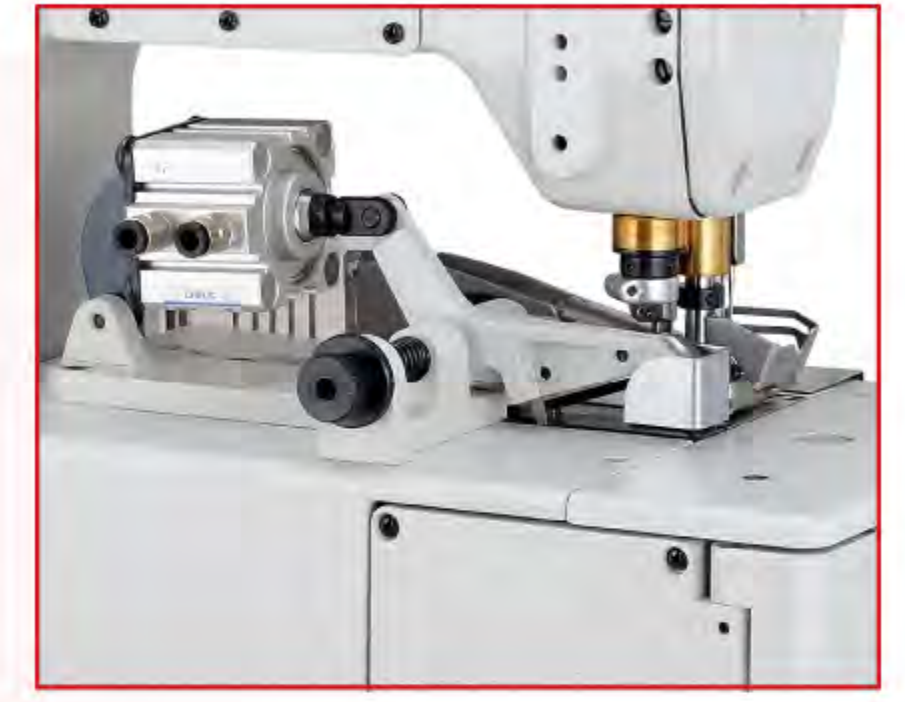

TCS02

- 電動式切帶裝置 (FTD7003, FTU7003上帶滾邊用)
Electric Type Tape Cutting Device
(For The Use Of Tape Binding Of FTD7003, FTU7003 Only).
- 適用蕾絲帶、鬆緊帶、滾條補強帶。
Suitable For Attaching Lace, Elastic Tape, Binding Tape, Reinforcement Tape etc.
- 可切斷寬度最大32mm的布料。
Maximum cutting width 32mm .
- 刀口與壓腳距離31.9mm。
The distance between cutting blade and the rear end of presser foot is 31.9mm.



TCS03

- 氣動式切帶裝置 (FTD7003上帶滾邊專用)
Pneumatic Type Tape Cutting Device
(For The Use Of Tape Binding Of FTD7003 Only).
- 適用蕾絲帶、鬆緊帶、滾條補強帶。
Suitable For Attaching Lace, Elastic Tape, Binding Tape, Reinforcement Tape etc.
- 可切斷寬度最大28mm的布料。
Maximum cutting width 28mm .
- 須配合空壓機使用 (5Kg/cm² 或 70PSI)
Must be used together with compressed air. (5Kg/cm² or 70PSI)
- 刀口與壓腳距離5.3mm
The distance between cutting blade and the rear end of presser foot is 5.3mm.



TCS09

- 氣動式切帶裝置 (FTD7003, FTD7069-0, FTD7069-2, FTD7069-4, FTD7069-6, FTU7003 上帶滾邊專用)
Pneumatic Type Tape Cutting Device
(For The Use Of Tape Binding Of FTD7003, FTD7069-0, FTD7069-2, FTD7069-4, FTD7069-6, FTU7003 Only).
- 適用蕾絲帶、鬆緊帶、滾條補強帶。
Suitable For Attaching Lace, Elastic Tape, Binding Tape, Reinforcement Tape etc.
- 可切斷寬度最大28mm的布料。
Maximum cutting width 28mm .
- 須配合空壓機使用 (5Kg/cm² 或 70PSI)
Must be used together with compressed air. (5Kg/cm² or 70PSI)
- 刀口與壓腳距離12.3mm
The distance between cutting blade and the rear end of presser foot is 12.3mm.





FTU 7003-0

- 上帶滾邊(滾領)車縫
Tape Binding(Collarett Binding).
- 針織、內褲、T恤等。
薄至中厚布料。
Knit underwear, T-shirt, briefs, ---etc.
Light to medium weight materials.



FTU 7011-0

- 下襠車縫
(適用於輕、薄、質軟、以及一般中厚布料)
Bottom Hemming (For Thin, Light Weight Material)
- 男女內衣褲、運動服等針織服裝；薄至中厚布料。
Men's & women's under wears, sports wears, ...etc.
Light to medium weight materials.



FTU7011-0

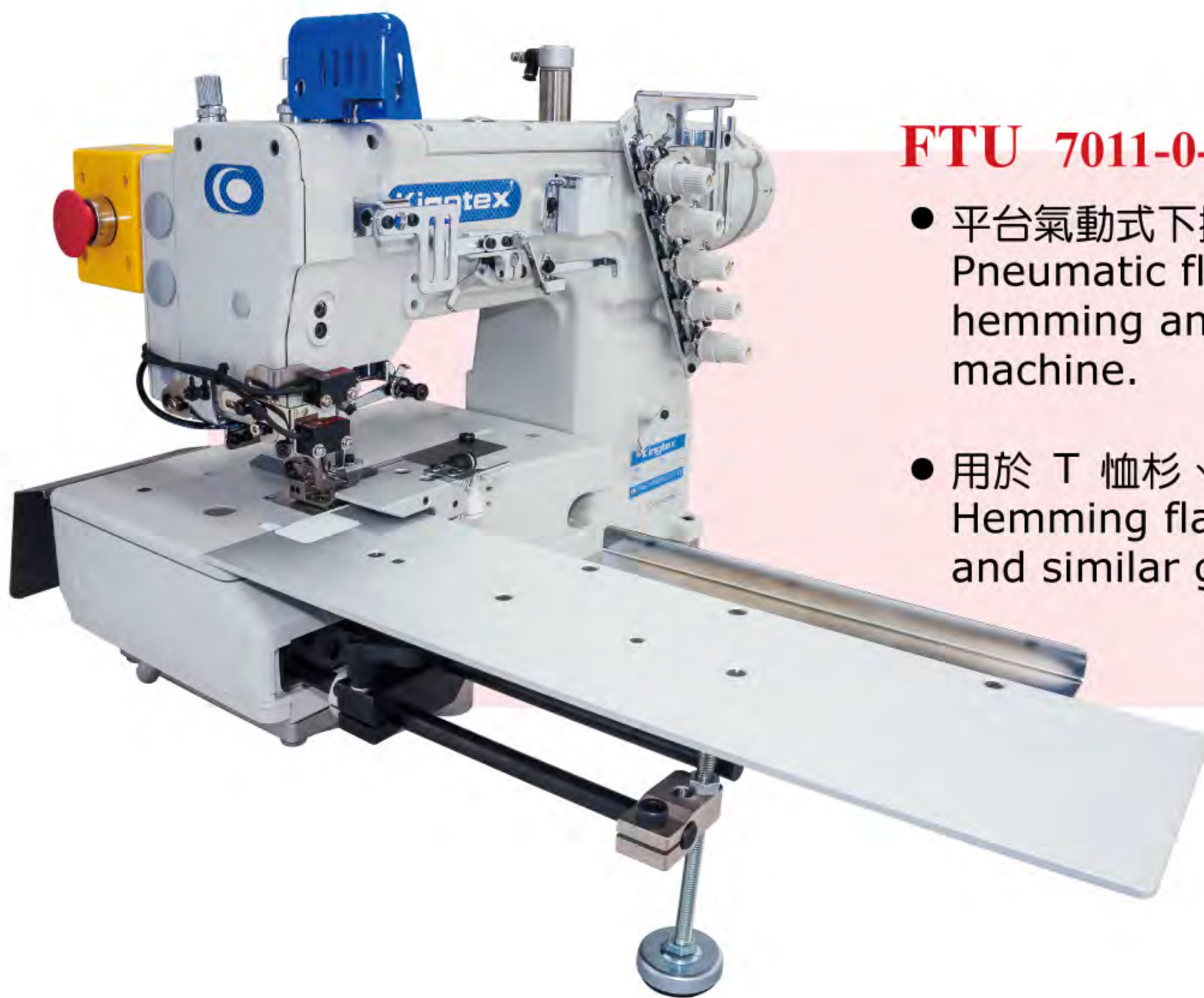

FTU 7011-0-356M/EG030

- 平台氣動式下擺及袖口自動車縫機
Pneumatic flat bed type, automatic bottom hemming and sleeve hemming interlock machine.
- 用於 T 恤衫、汗衫等平坦衣物的折縫工序。
Hemming flat sleeves of T-shirts, underwear and similar garments.
- 折邊寬度：15~30mm。
Hem width：15~30mm.



			 m.m.	 m.m.			 m.m.	 UY128GAS m.m.		OPTIONAL DEVICE
FTU7003-0-□□□M	3	5	4.8/5.6/6.4	1.4~4.0	1:0.7~1:2	1:6	5	#11	5500	● TCS01 ● TCS02 ● TCS09
FTU7003-0-356S	3	5	5.6							
FTU7011-0-240□	2	4	4.0							
FTU7011-0-348□	3	5	4.8							● UFP-FB ● UFE-FB
FTU7011-0-356□	3	5	5.6							
FTU7011-0-364□	3	5	6.4					#11		
FTU7011-0-248M/EG030	3	5	4.8							
FTU7011-0-356M/EG030	2	4	5.6	1.4~4.0	1:0.7~1:2	1:6	5		5500	
FTU7011-0-364M/EG030	3	5	6.4							
FTU7011-0-240H	2	4	4.0							
FTU7011-0-□□□H	3	5	4.8/5.6/6.4					#14		● UFP-FB ● UFE-FB
FTU7011-0-3□□W	3	5	5.6/6.4					#11		
FTU7060-0-460M	4	6	6.0	1.4~4.0	1:0.7~1:2	1:6	5	MY1014B #11	5500	● UFP-FB ● UFE-FB
FTU7200-0-3□□H	3	5	5.6/6.4	1.4~4.0	1:0.7~1:2	1:6	5	#14	5000	

□□□:348, 356, 364
□□:56, 64

□:M, L



UFE-FB

- 電動式自動切線裝置 (直驅上送平台型繙縫機用)
Electric Type Thread Trimming System (For Direct Drive Top Feed Flat Bed Interlock Machines)

特點 Feature

- 本裝置可適用於所有 FTU 系列機種，但不單獨供應此裝置。
Suitable for all FTU series machines, but only supply together with machine head.



UTE07F: 電動切底線裝置
Electric Under Bed Thread Trimmer



STC04: 電動切上飾線裝置
Electric Top Cover Thread Trimmer



PFE2F: 電動式壓腳提昇裝置
Electric Presser foot Lifter

UFE - FB1 ① ② ③ ④	① 自動切線裝置代號	① Under bed thread trimmer device
	② 機型 C:方筒型繙縫機 F:平台型繙縫機	② Model C:Cylinder bed interlock F:Flat bed interlock
	③ 動力 P:氣動式 E:電動式	③ Power P:Pneumatic Type E:Electric Type
	④ 裝置組合代號	④ Combination of devices

MODEL	電動式自動切線裝置 Electric Type Thread Trimming System		
	(UTE07F) 切底線裝置 Under Bed Thread Trimmer	(STC04) 切上飾線裝置 Top Cover Thread Trimmer	(PFE2F) 壓腳提昇裝置 Presser foot Lifter
UFE-FB1	●	●*	●
UFE-FB4	●		●

* 包裝於附件箱中 Packed in the accessories box

FTU



UFP-FB

- 氣動式自動切線裝置 (直驅上送平台型繙縫機用)
Pneumatic Type Thread Trimming System (For Direct Drive Top Feed Flat Bed Interlock Machines)

特點 Feature

- 本裝置可適用於所有 FTU 系列機種，但不單獨供應此裝置。
Suitable for all FTU series machines, but only supply together with machine head.
- 須配合空壓機使用，(5kg/cm² 或 70PSI)
Compressed air is required(5kg/cm² 或 70PSI)



UTD07F: 電動式切底線裝置
Electric Under Bed Thread Trimmer



STB04: 氣動式切上飾線裝置
Pneumatic Top Covering Thread Trimmer



WPC03: 撥線裝置
Air Wiper

UFP - FB1 ① ② ③ ④	① 自動切線裝置代號	① Under bed thread trimmer device
	② 機型 C:方筒型繙縫機 F:平台型繙縫機	② Model C:Cylinder bed interlock F:Flat bed interlock
	③ 動力 P:氣動式 E:電動式	③ Power P:Pneumatic Type E:Electric Type
	④ 裝置組合代號	④ Combination of devices

MODEL	氣動式自動切線裝置 Pneumatic Type Thread Trimming System			
	(UTD07F) 切底線裝置 Under Bed Thread Trimmer	(STB04) 切上飾線裝置 Top Cover Thread Trimmer	(WPC03) 撥線裝置 Wiper	壓腳提昇裝置 Presser foot Lifter
UFP-FB1	●	●*		●
UFP-FB2	●		●	●
UFP-FB3	●	●*	●*	●
UFP-FB4	●			●

* 包裝於附件箱中 Packed in the accessories box