

- 機型編號說明
- MODEL NUMBERING

GLK-1900C-SS

1

2

3

機型 / Machine Type:
GLK-19:標準機型
Standard type

用途代號 / Application Code:
00C:套結
Bar tacking
03C:釘釦
Button sewing
05C:套結和釘釦
Bar tacking and Button sewing
10C:小型花樣
Shape-tacking
11C:細筒型
Small cylinder
20C:電子鬆緊帶專用
Elastic Loop Joined Sewing
50C:全自動鬆緊帶專用
Automatic elastic waistband attaching
60C:椅墊專用
Cushion Shape-tacking

適用裁片厚度 /
Materials Thickness:

SS:中薄類至厚料
For medium to light weight materials.

HS:厚類,如牛仔褲
For heavy materials, such as jeans.

FF:鬆緊帶縫合
For elastic waistband attaching

鬆緊帶縫製圖案附表

鬆緊帶縫製圖案							
圖案號	縫製圖案	長度 (mm)	高度 (mm)	圖案號	縫製圖案	長度 (mm)	高度 (mm)
70		182					
71		113		74		173	
72		131	40 12				40 12
73		155		75		181	

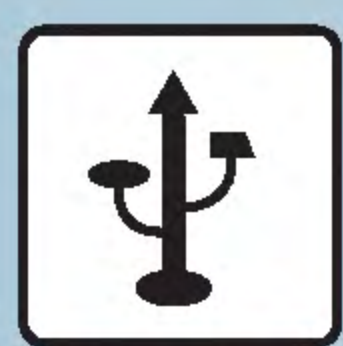

存儲端口
Storage Ports



集成電控
Computer controls



記憶體
Memory



轉速
Sewing Speed



計蹠長度
Stitch length



壓腳高度
Height of presser foot



機計型號
Needle



擺梭
Shuttle Bod



自動加油
Lubricating oil



工件範圍
Length of cylinder bed



自動切線
Thread cutting



重度
GW / NW



體積
Storage Ports



GLK-1900C-SS

○ 一般特性
○ GENERAL FEATURES

- 專利開發智慧型自動偵測織物厚薄感知系統。可自動依擊針針尖偵測織物的厚、薄，而自動加、減力量，無須另行設定。
The machine will follow the feedback of needle tip to detect the thickness of fabric for which increase or decrease the sewing power. Don't need to reset the machine.
- GLK1900C-SS最高實際操作速度可達3,000轉/分；GLK1903C最高實際操作速度可達2,700轉/分
The real operation speed for GLK1900 series is 3,000 rpm. The real sewing speed for GLK1903A is 2,700 rpm.
- 自主潤滑系統先進的無油設計，前蓋部分無機油潤滑徹底解決漏油的困擾。
Auto lubrication system and advanced dry-head technology design, The front cover part (needle bar and needle thread take-up) don't require any lubrication to solve the leaking problem.
- 簡便的操控面板，省略循環按鍵可直接挑選調整項目，簡單，快速尋找所需的功能。
The simplify control panel omitted the "Selection" key which to pick up the adjust item directly. To find the needed function in easy and fast.
- 特殊記憶程式，可執行25組循環花樣縫，每一組循環縫可儲存25種不同的車縫花樣。
The special memory program offers 25 different cycled sewing patterns, each of which combines could be stored 25 different sewing patterns in the memory.
- 多樣化的功能，可依使用者的需求自行設計所需的車縫花樣。
Flexible performance, follow the user's demand to design their needed sewing patterns.

NEWEST PRACTICAL MODEL

全新實用機種 · 一機雙功能！

2 FUNCTIONS IN 1 MACHINE !

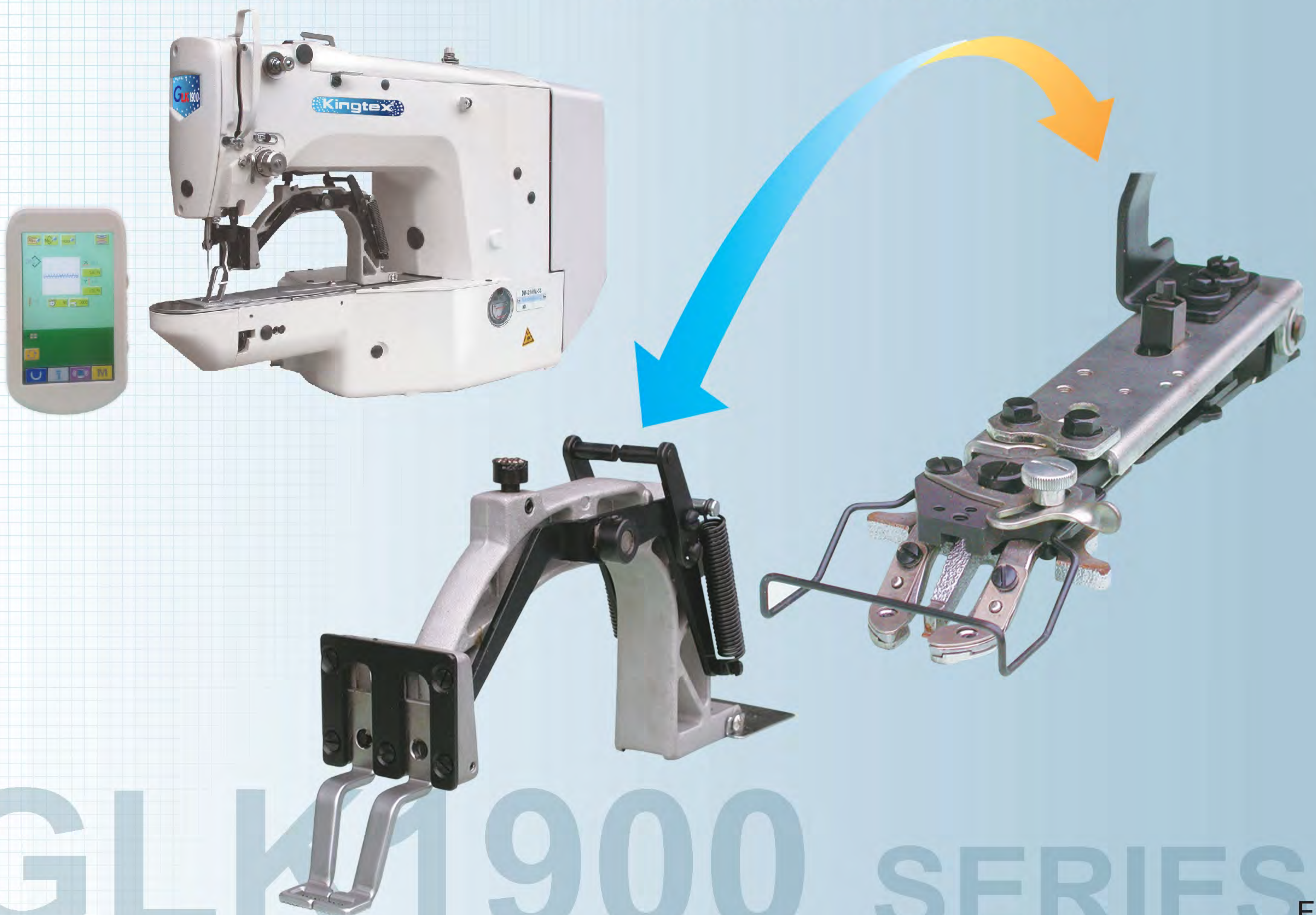











GLK 1900C-SS

- 全新觸控螢幕全自動直驅式高速電子套結機
Computer-controlled, Directly-drive Type, High Speed, Bar-tacking Machine

特點Feature

- 可記憶數據：999花樣
(可追加至150個花樣的縫製數據)。
Number of data that can be input : 200 patterns (for up to 150 patterns, sewing date can be added)
- 擴大、縮小機能：20-200%(1%單位)
隨縫目長度增、減方式來調整。
Enlarging/Reducing facility : 20% ~ 200% (1% per adjustment), Pattern enlargement/Reduction can be done by increasing/decreasing the stitch length.

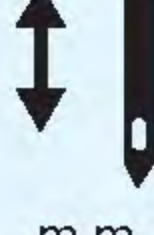

			 m.m.	 m.m.	 m.m.	 m.m.	 R.P.M. (max)	OPTIONAL DEVICE
GLK-1900C-SS	DP X 5(14)		40	30		41.2	3000	
GLK1900/AHS	DP X 17(21)		40	30	17	45.7	3000	●04A
GLK1900/AFS	DP X 5(11)	2	40	30		41.2	3000	
GLK1900/AFF	DP X 17(14)		25	52		45.7	2200	
GLK1903A	DP X 17(14)	2	40	30	17	45.7	2700	









GLK 1903C

- 全新觸控螢幕全自動直驅式高速電子平縫釘釦機
Computer-controlled, Directly-drive Type, High Speed, Lockstitch, Button Sewing Machine.

特點Feature

- 本機提供超過50種以上的標準釘釦樣式，能充分提供使用者設計上的需求與變化。
This machine is equipped with semi-rotary large capacity shuttle hook.
Our machine's standard is providing more than 50 different sewing patterns that most of user's demands or designs can be satisfied.

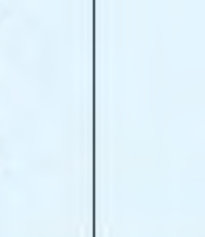

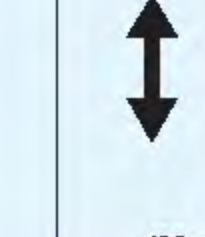
			 m.m.	 m.m.	 m.m.	 m.m.	 R.P.M. (max)
GLK-1903C	DP X 17(#14)	2	08	032	13	45.7	2700









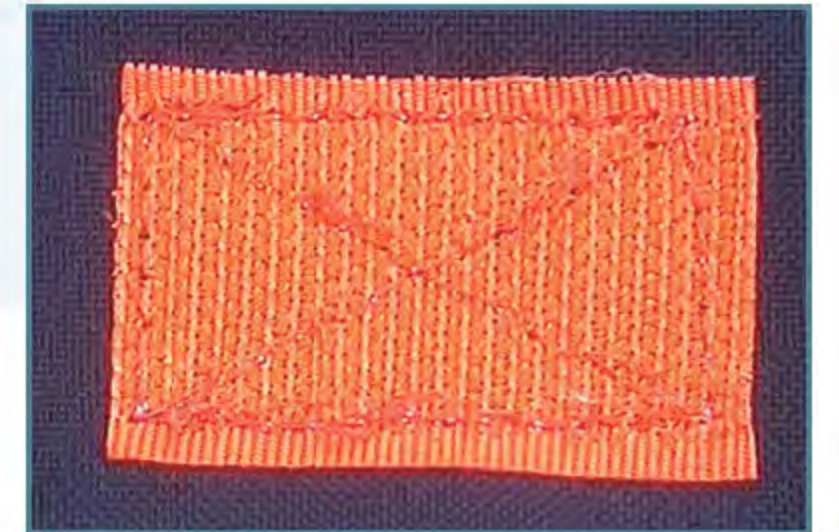

GLK 1910C-HS

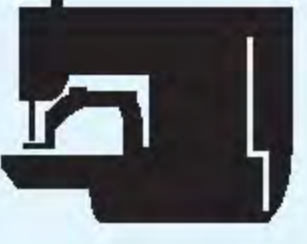
- 全新觸控螢幕全自動直驅式高速電子花樣機
Computer-controlled, Directly-drive Type, High Speed, Shape-tacking Sewing Machine

特點Feature

- 本機器具備40mm×48mm的縫製範圍。
The machine offers sewing area of 40mm X 48mm.
- 配備特有中壓腳設備，可因應各種縫製要求。
可在螢幕自由製作圖案。
The machine equipped with intermediate presser foot that suitable for varied applications.



			 m.m.	 m.m.	 m.m.	 m.m.	 R.P.M. (max)	OPTIONAL DEVICE
GLK-1910C-HS	DP X 17(21)	2	40	48	17	45.7	3000	●04A









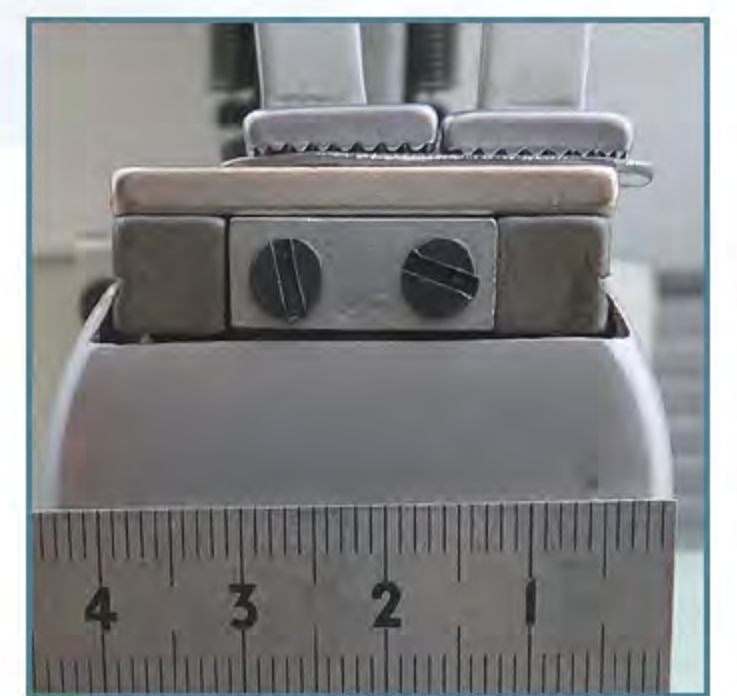

GLK 1911C-HS

- 全新觸控螢幕全自動直驅式細筒花樣機
Computer-controlled direct-drive type small cylinder bed pattern sewing machine

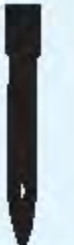
特點Feature

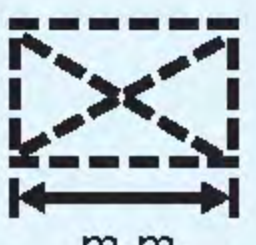
- 圓周135mm的特殊細筒型設計，可輕易深入小口徑的圓筒型織物中，提供所需要的車縫。如鞋後跟、衣袖、褲腿……等
The cylinder bed circumference of 135 m.m. that is designed for easy sewing for small-bore tubular goods. For example, the heel of shoe、sleeve、trousers.....etc.
- 工作範圍：30mm X 40mm
Working area : 30 mm X 40 mm



			 m.m.	 m.m.	 m.m.	 m.m.	 R.P.M. (max)	OPTIONAL DEVICE
GLK-1911CHS	DP X 17 (14-23#)	2	30	40	17	0.1~12.7	2000	











GLK 1920C-FF

- 全新觸控螢幕半自動直驅式高速電子鬆緊帶專用
Computer-controlled, Directly-driving Type,
High Speed, Elastic Loop Joined Sewing Machine.

特點Feature

- 本機器具備52mm×12mm的縫製範圍，可因應多樣的縫製要求。
The machine provides a sewing area of 52mm X 12mm that able to offers various applications.
- 專門針對連結鬆緊帶而設計、呈現出舒適美觀平整的觸感。
This machine is special designed for joining elastic loop operation that offers a fast and smooth joined sewing.
- 針對各式各樣鬆緊織物上的需求，加以變化及設計。
可自由編輯花樣
Based on different kinds of elastic tape requirements, the sewing pattern can be changed and be re-designed.



								OPTIONAL DEVICE
GLK-1920C-FF	DP X 17(#14)	2	52	12	17	45.7	2200	

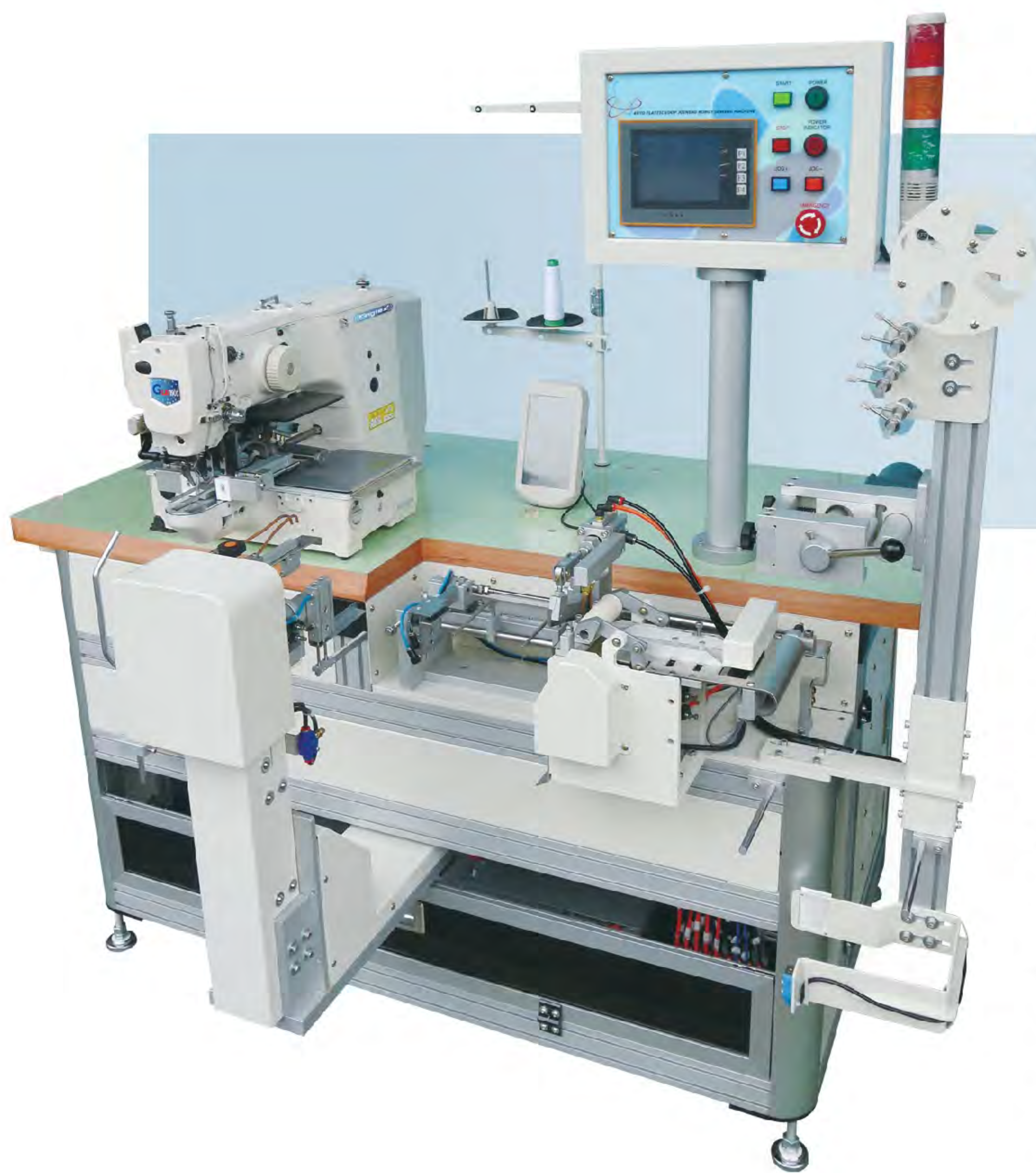









GLK 1950C-FF

- 全新觸控螢幕全自動鬆緊帶縫合機
Automatic Computer-controlled,
Direct-driving Type, High Speed,
Elastic Loop Joined Sewing Machine

特點Feature

- 本機器具備60mm×20mm的縫製範圍，可因應多樣的縫製要求。
The machine offers a sewing area of 60mm X 20mm with various applications.
- 自動送料功能，可自動傳送裁剪好的鬆緊帶到縫製部位，不需手工操作。
With automatic feeding function, the elastic tapes can be fed and be cut automatically without manual operation.
- 自動裁剪功能，可根據鬆緊的長度需求實現自動裁縫。
With automatic cutting function, the elastic tapes can be cut according to different desired lengths without manual operation.
- 針對各式各樣鬆緊織物上的需求，加以變化及設計，可實現自動完美拼接縫製。
Basing on the different types of fabrics requirements, the various patterns can be designed easily and perfect joined sewing can be obtained easily as well.



								OPTIONAL DEVICE
GLK-1950C-FF	DP X 17(14)	2	60	20	17	45.7	2200	











GLK 1960C-HS

- 全新觸控螢幕半自動直驅式椅墊專用電子花樣機
Computer-controlled, Directly-driving Type, Cushion Shape-tacking Machine

特點Feature

- 本機器具備20mm×20mm的縫製範圍。
The machine offers a sewing area : 20mm X 20mm
- 壓腳高變可達70mm
The height of presser foot is 70mm
- 縫製速度可達到1200轉
The maximum speed is 1200rpm



			 m.m.	 m.m.	 m.m.	 m.m.	 R.P.M. (max)	OPTIONAL DEVICE
GLK-1960C-HS	DP X 17(#14)	2	20	20	70		1200	







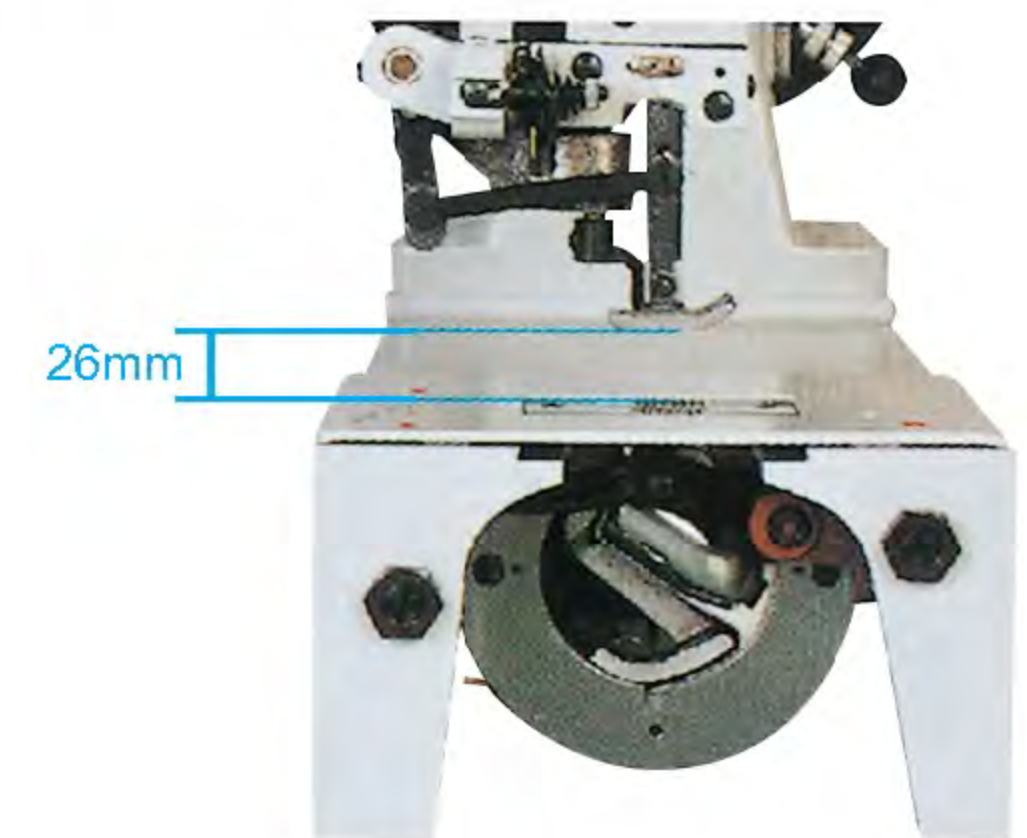
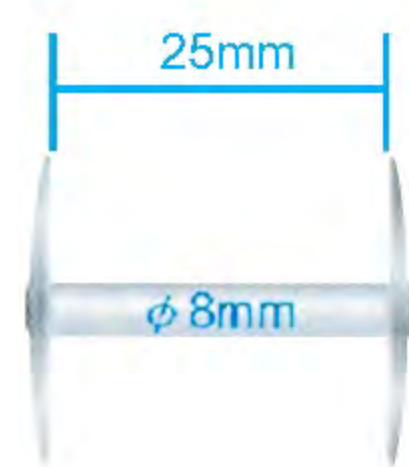

GLK 190-L

- 帶輸入功能大型極厚料電腦花樣機
Computer-controlled Pattern Sewing Machine with input function for large extremely thick materials

特點Feature

- 本機配有半迴轉式旋梭(大月眉)，適用於安全帶、貨物吊索、布輪、降落傘背帶、太空包、書籍裝訂等等之極厚物料之縫製。
This machine is equipped with semi-rotary large capacity shuttle hook, suitable for sewing extremely thick materials. Suitable for the products of safety and logging belts, luggage, cargo shlings, buffing wheels, harnesses, construction barriers, parachutes, ballons and book binding.

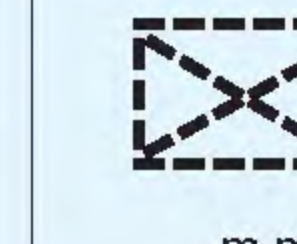
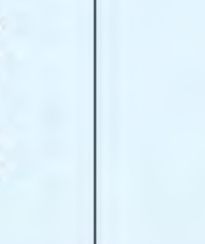
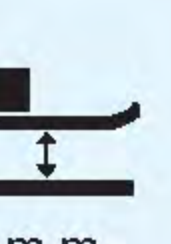

			 m.m.	 m.m.	 m.m.	 m.m.	 R.P.M. (max)	OPTIONAL DEVICE
GLK 190-L	Schmetz 1000 (#250)	#00~ #00	300	200	26mm 32mm(CK-767-FH)	66	700	











GLK 3020-AE

- 帶輸入功能電腦花樣縫紉機
Computer-controlled Pattern Sewing Machine with input function

特點Feature

- 液晶顯示器
LCD Panel.
- 中壓腳自動高低提升功能
Presser foot : Auto up and down
- 步進馬達多加裝編碼器，可讓步進馬達反應速度增快，避免出現走位之情形
Installing an encoder to stepping motor will boost the reaction of speed and avoid incorrect positioning for the stepping motor.
- 最高縫製速度2700轉
Maximum sewing speed : 2700 rpm.

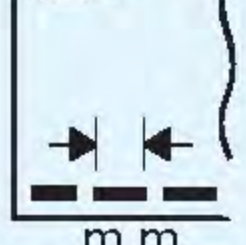

			 m.m.	 m.m.	 m.m.	 m.m.	 R.P.M. (max)	OPTIONAL DEVICE
GLK-3020-AE GLK-3020-AE-XL GLK-2210-AE GLK-2210-AE-XL GLK-1306-AE GLK-1306-AE-XL	DP X 17 (14-23#)	2	300	200	32	0.1~ 12.7	2700	



GLK 2210-45-AE







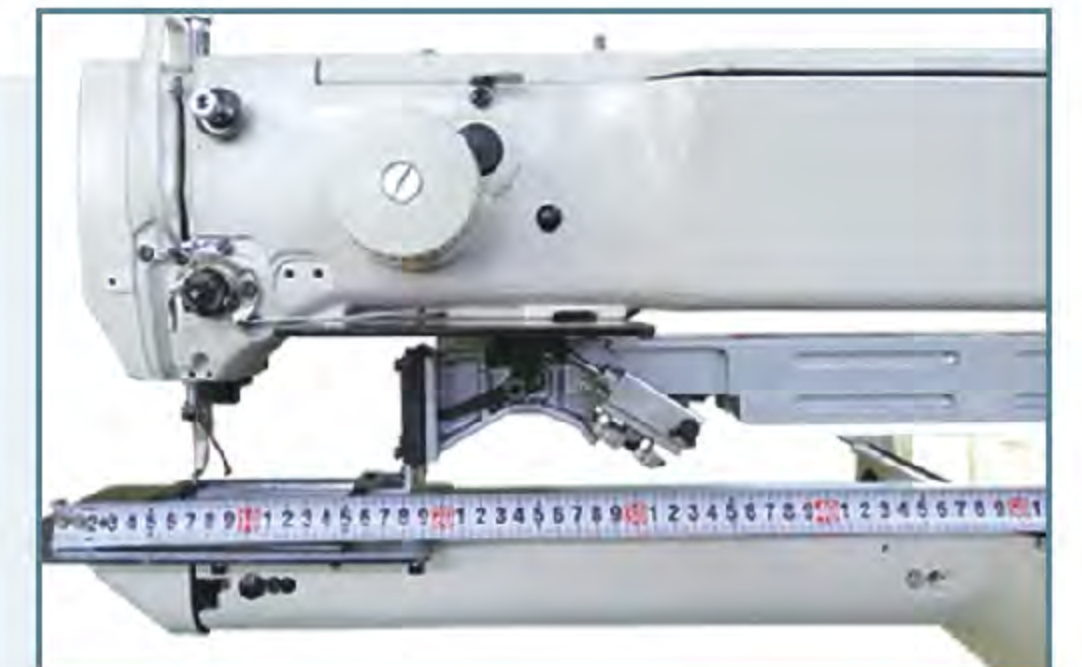

- 帶輸入功能電腦長筒型花樣縫紉機
Computer-controlled Cylinder Bed Type, Pattern Sewing Machine with input function

- 適用於一般窄管長褲、牛仔褲
For general legs of trousers, jeans.

特點Feature

- 液晶顯示器
LCD Panel.
- 中壓腳自動高低提升功能
Presser foot : Auto up and down
- 步進馬達多加裝編碼器，可讓步進馬達反應速度增快，避免出現走位之情形
Installing an encoder to stepping motor will boost the reaction of speed and avoid incorrect positioning for the stepping motor.
- 最高縫製速度2700轉
Maximum sewing speed : 2700 rpm.
加大操作空間，使縫紉更方便
Increased operating space. Make sewing easier.



			 m.m.	 m.m.	 m.m.	 m.m.	 R.P.M. (max)	OPTIONAL DEVICE
GLK-2210-45-AE GLK-2210-45-XL	DP X 17 (14-23#)	2	220	100	32	0.1~ 12.7	2700	



KBH 1790-S

- 高速電子平頭鎖眼機
Computer-controlled High-speed Lockstitch Buttonhole Machine

特點 Feature

- 具備彩色液晶觸控式的新型操作控制盤。
User-friendly colorful control panel is our unique design.
- 附有急停裝置，車縫行進中可即行停車。
Equipped with emergency breaking system, the machine can be stopped in case of emergency.



短壓腳 Short Presser Foot
工作範圍：25m/m
Operating: 25m/m

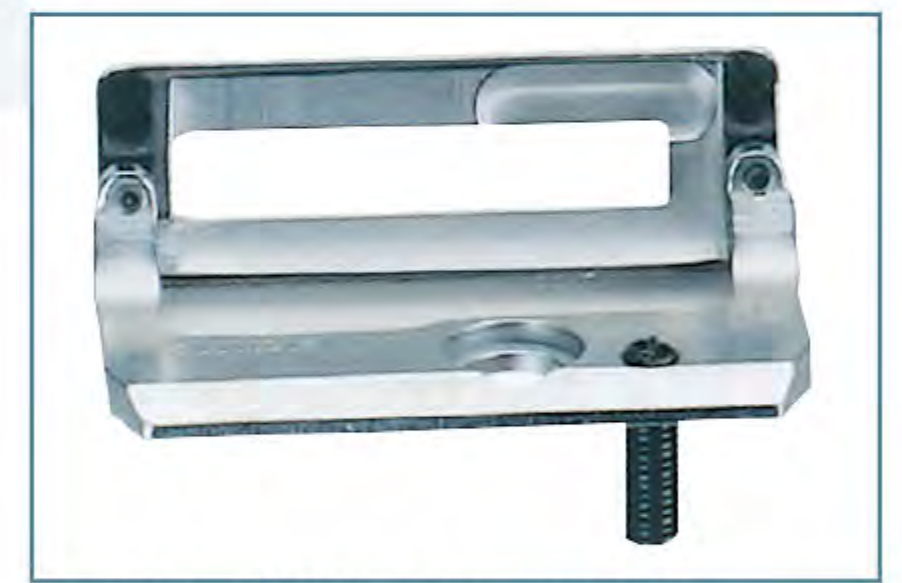



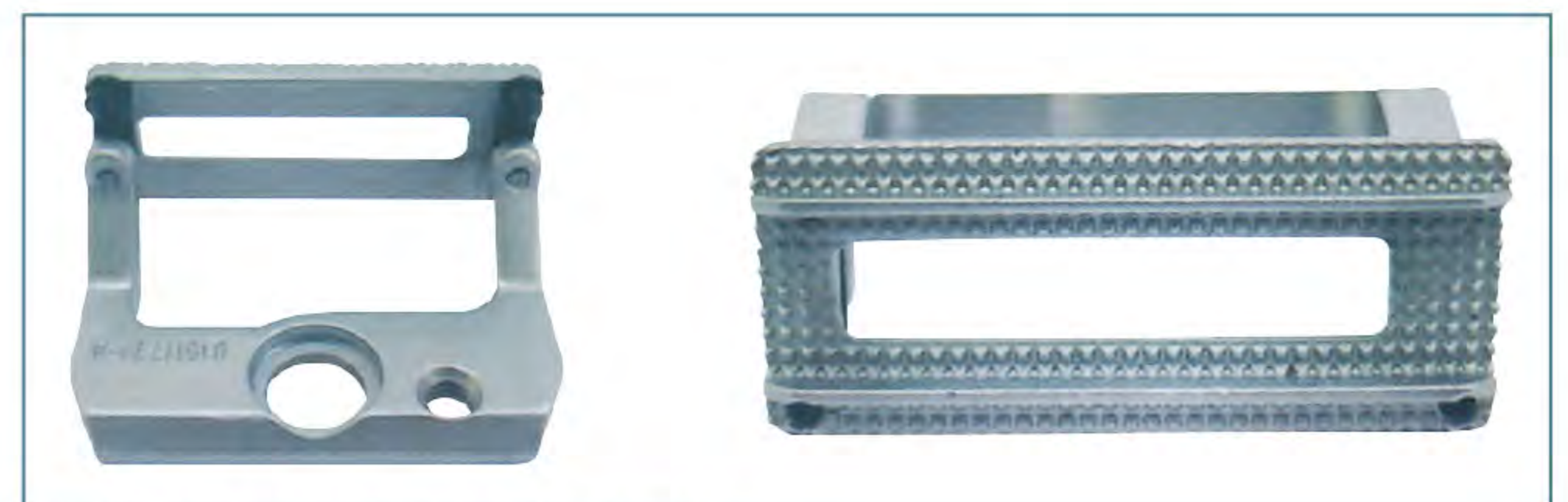

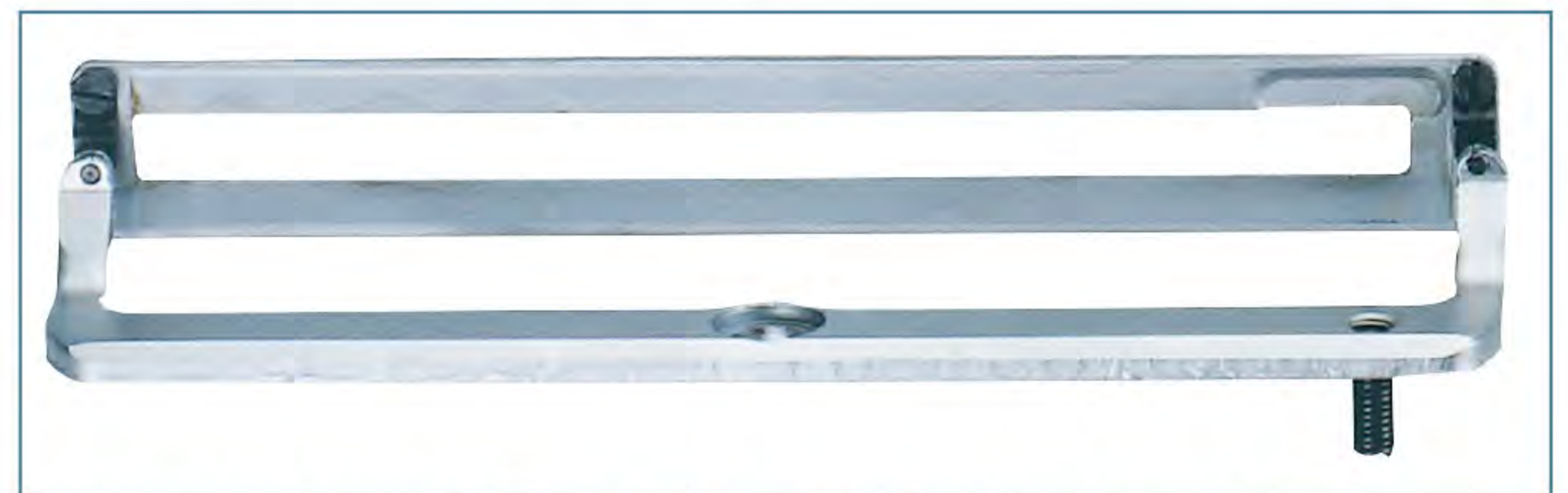

中壓腳 Middle Presser Foot
工作範圍：35m/m
Operating: 35m/m



針織壓腳 The Presser Foot for Knits

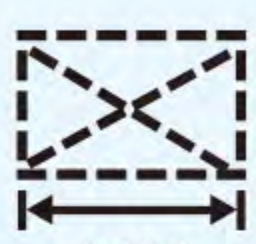

長壓腳 Long Presser Foot 工作範圍：120m/m Operating: 120m/m

			 m.m.	 m.m.	 m.m.	 m.m.	 R.P.M. (max)	OPTIONAL DEVICE
KBH-1790-S KBH-1790-L	DP X 17(14)	2					3600	