

○ 機型編號說明

○ MODEL NUMBERING

**MT4504P □ - 064 □ / PMD**

1

2

3

4

5

6

機型 / Machine Type:

- MT45 : 一般車縫(標準型)  
General Sewing (Standard Type)
- MTS45 : 一般車縫(短筒型)  
General Sewing (Short Cylinder Bed Type)
- MT40 : 一般車縫(單鏈式)  
General Sewing (Single Chain Stitch)
- MTD45 : 直驅式馬達  
With Direct Drive Servo Motor

針數 / Number Of Needle:

- 01:1針,Single Needle
- 04:4針,4-Needle
- 06:6針,6-Needle
- 09:9針,9-Needle
- 12:12針,12-Needle
- 13:13針,13-Needle
- 17:17針,17-Needle
- 23:23針,23-Needle
- 25:25針,25-Needle
- 33:33針,33-Needle
- 38:38針,38-Needle
- 50:50針,50-Needle

針距代碼 Needle Distance Code	針距寬 (inch/m.m.) Needle Distance
032	1/8"
048	3/16"
050	5m.m.
064	1/4"
085	1"
095	1-1/8"
106	1-1/4"
127	1-1/2"

齒形 / Puller Teeth:

- 未標示:上滾輪28齒、  
下滾輪15齒
- 0:上滾輪0齒、下滾輪0齒
- 1:上滾輪18齒、下滾輪10齒
- 2:上滾輪22齒、下滾輪12齒
- 3:鐵輪

齒輪長度:

- MT4501P~MT4504P:62 m.m.
- MT4506P~MT4523P:79 m.m.

Standard Type:

- Upper Roller:28 Teeth
- Lower Roller:15 Teeth
- 0:Upper Roller: 0 Teeth
- Lower Roller: 0 Teeth
- 1:Upper Roller:18 Teeth
- Lower Roller:10 Teeth
- 2:Upper Roller:22 Teeth
- Lower Roller:12 Teeth
- 3:Upper Grooved Steel Roller

Roller Length:

- MT4501~MT4504P:62 m.m.
- MT4506P~MT4523P:79 m.m.

可選擇加裝之裝置 / Optional Device:

- AL004:壓腳提升裝置  
Presser Foot Lifting Device
- TB004:補強帶車縫裝置  
Reinforce Tape Attaching Device
- PMD:下送式送料裝置  
Lower Front Feed Metering Device
- UT04A:切線機構  
Under Bed Thread Trimmer For 4-Needle
- UT12A:切線機構  
Under Bed Thread Trimmer For 12-Needle
- TCB41:氣動式切帶裝置  
Pneumatic Type Tape Cutting Device
- TCS41:氣動式切帶裝置  
Pneumatic Type Lower Front Tape Cutting Device

次機型 / Sub-class:

- A:兩件組壓腳底  
Bisector Presser Foot
- B:大針孔  
Bigger Needle Hole



P

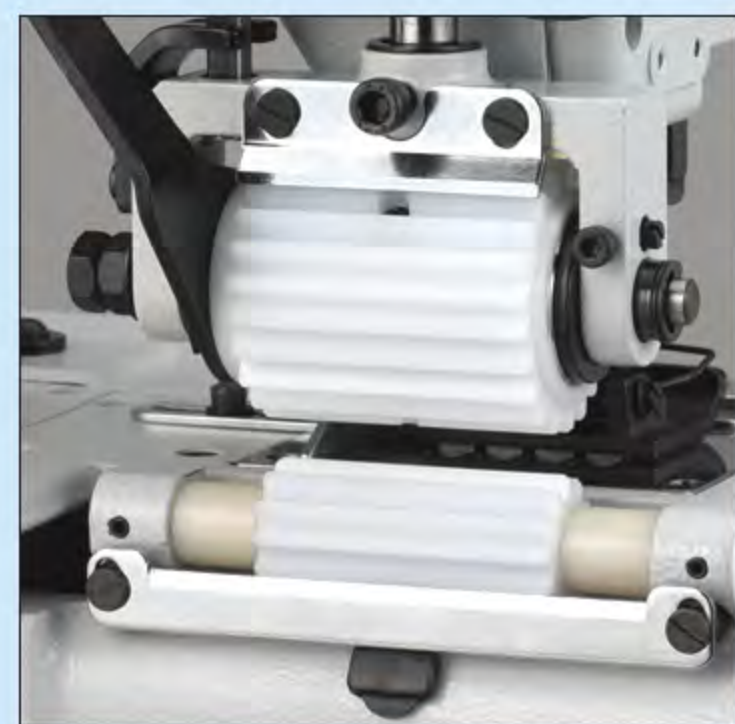

P2



P0



P3

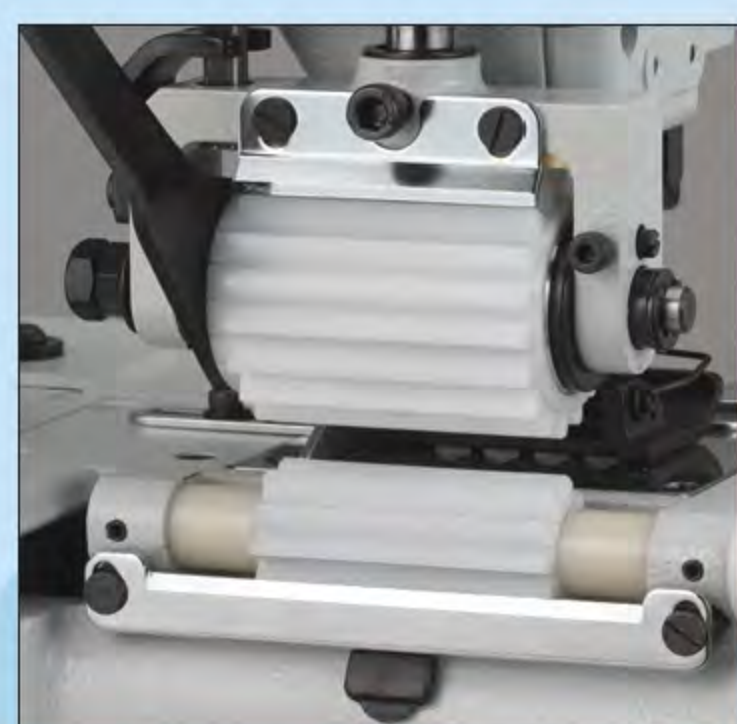

P1



MT4504P1-064



MT4504P3-064A



MT4504P-048

○ 一般特性  
○ GENERAL FEATURES

- 全自動供油潤滑系統，延長機台壽命。(如圖A、B)
- 全新筒型外型設計，車台更利於圓筒型衣物之縫紉。  
筒座圓周：430m.m.(含拖輪)。可更換不同規格組件，適合多樣車縫。(如圖C)
- 密封式天秤結構，且斜至於車頭上，完全防止漏油，減少車縫時的震動，增加作業人員車縫時的舒適。按鈕式調整縫目疏密，簡易快捷。(如圖D)
- 具備省力且靈活的鬆線機構。(如圖E、F)

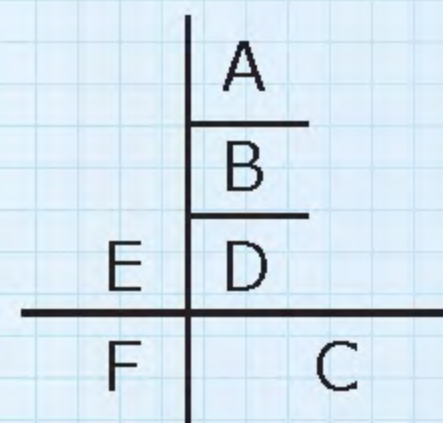
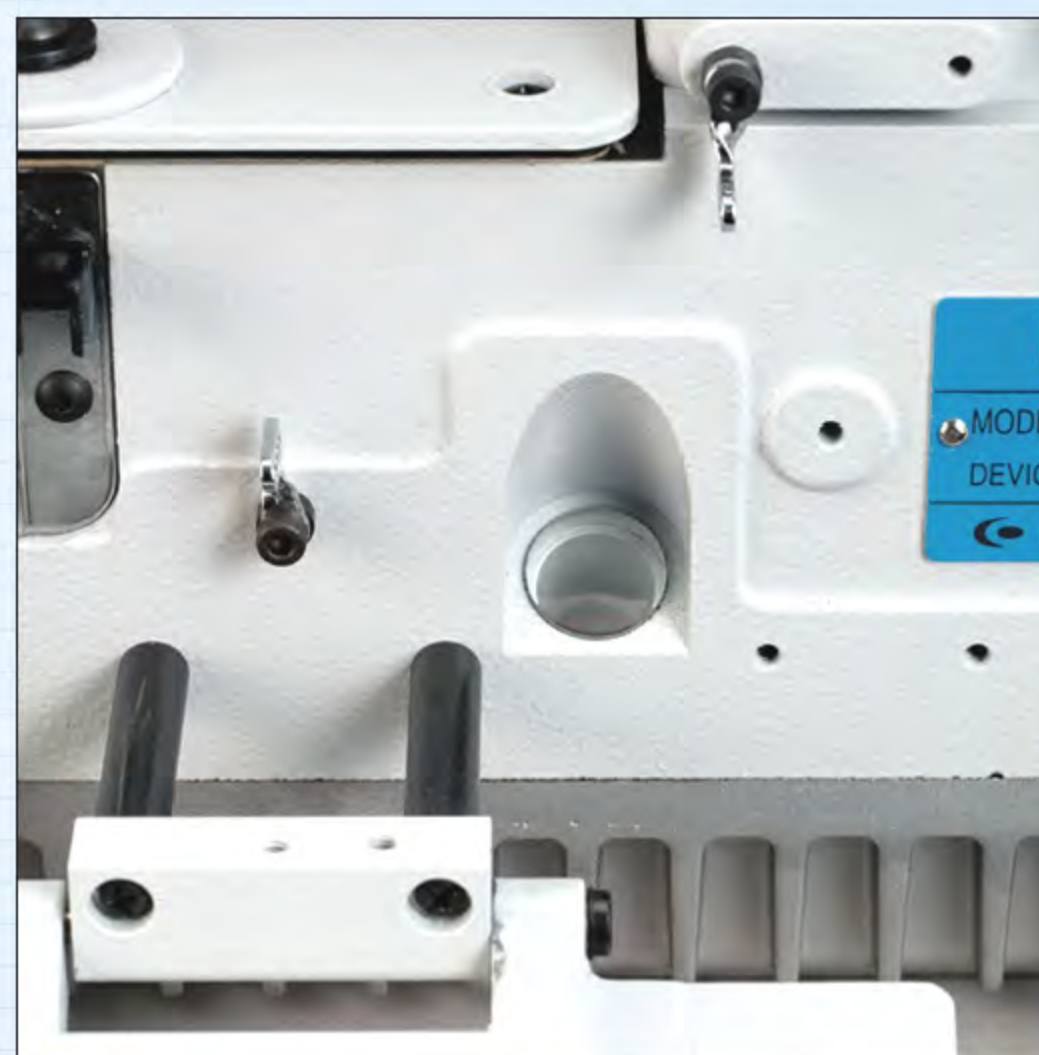
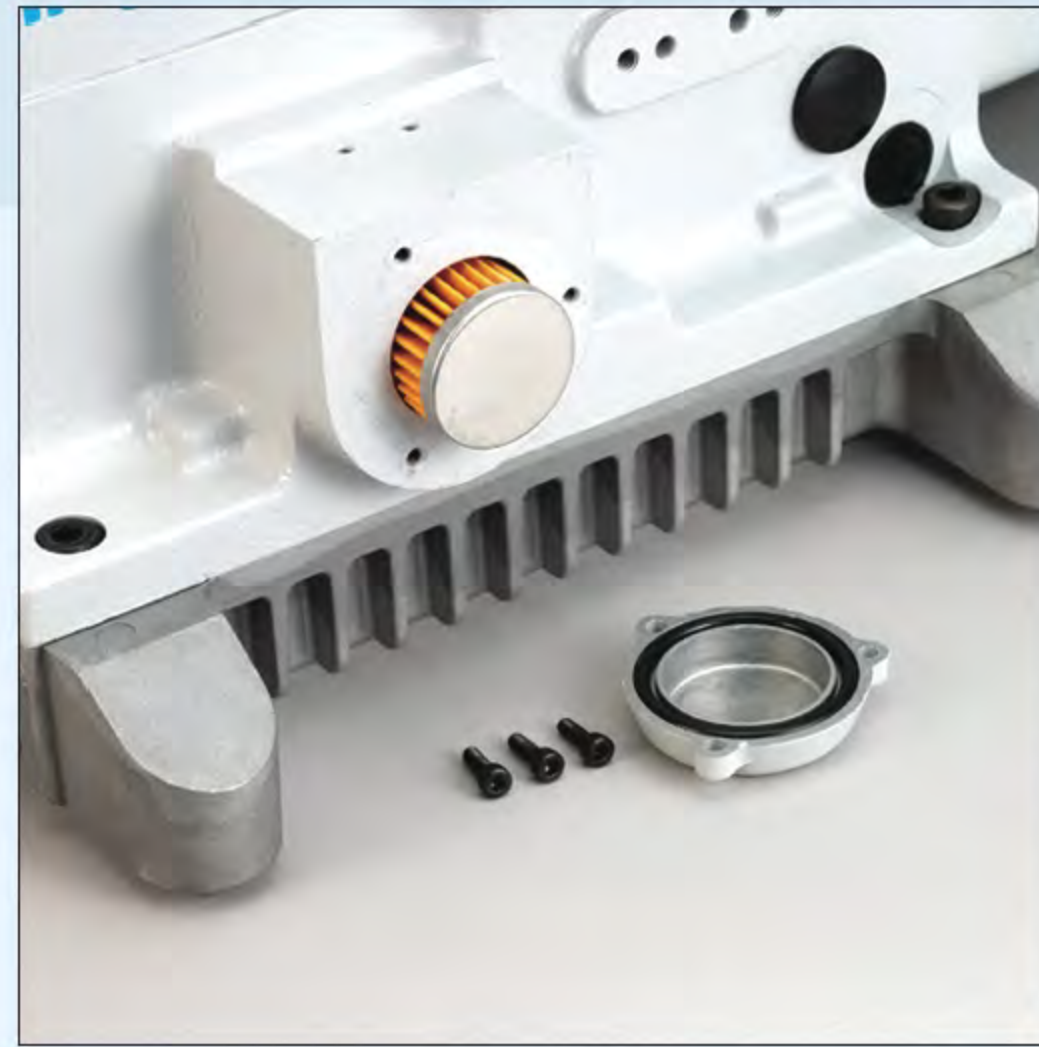

- With automatic oiling system, can provides longer machine and parts life.(Fig. A,B)
- Brand new cylinder bed design can provides easy and smooth sewing,especially for tubular goods.  
Cylinder bed circumference: 430m.m. (including the lower roller of rear puller).  
Different sewing requirements can be achieved by changing different gauge parts.(Fig. C)
- Patented thread take up system can provides easy sewing , reduces sewing vibration and prevents oil leaking.Push-bottom type stitch length regulator makes stitch length adjustments Easily.(Fig. D)
- Equipped with light and soomth thread tension release mechanism. (Fig. E,F)

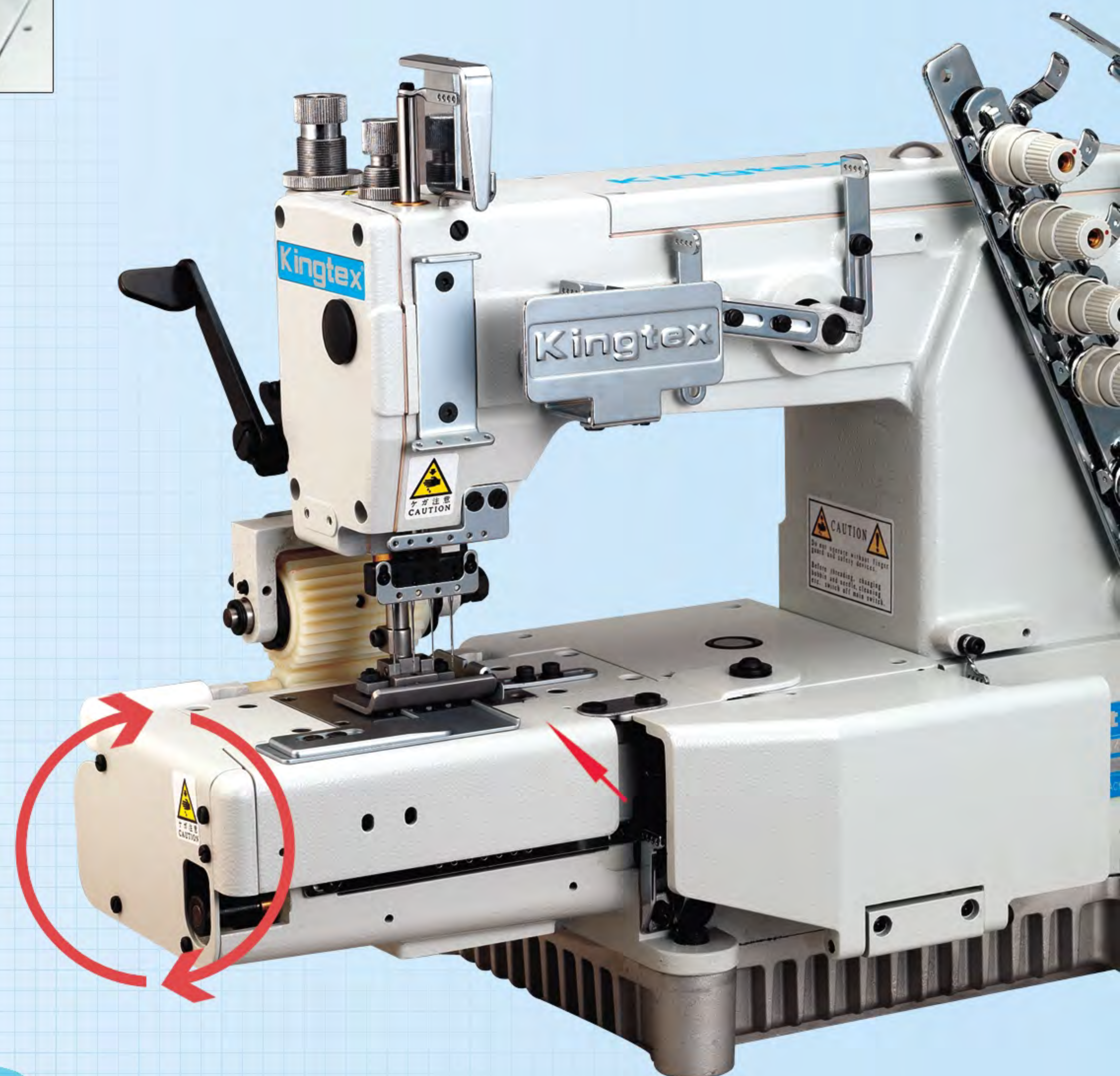

MT



### MT 4504P

- 四針雙鏈式環縫筒車  
4-Needle Double Chain Stitch Machine.
- 適用於短褲、運動短褲等褲頭上鬆緊帶用縫紉機。  
平鬆緊帶、環狀鬆緊帶均可使用。  
Suitable for attaching elastic tape to the waist of trunks, boxers and similar garments.



### MT 4506P







- 六針雙鏈式環縫筒車  
6-Needle Double Chain Stitch Machine.
- 適用於短褲、運動短褲等褲頭、上帶車縫紉機。  
平鬆緊帶、環狀鬆緊帶均可使用。  
Suitable for attaching elastic tape or line tapes to the sports pants or jackets and similar garment.

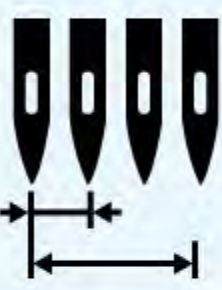

### MT 4509P

- 九針雙鏈式環縫筒車  
9-Needle Double Chain Stitch Machine.
- 適用於短褲、運動短褲等上鬆緊帶用縫紉機。  
平鬆緊帶、環狀鬆緊帶均可使用。  
Suitable for attaching elastic tape to the waist of trunks, boxers and similar garments And suitable for various applications, such as trunks, sports pants.



								OPTIONAL DEVICE
* MT4504P-032	4	8	Multi-needle distance	1.4~3.6	12	UO113	4000	●AL004 ●TB004 ●PMD
MT4504P-064			3/4" (19.1mm)					
MT4504P-085			1" (25.4mm)					
MT4504P-095			1-1/8" (28.5mm)					
MT4504P-106			1-1/4" (31.8mm)					
MT4504P-127			1-1/2" (38.1mm)					
MT4504P-048-191			3/16"-3/4"-3/16" (4.8-19.1-4.8mm)					
MT4504P-048-254			3/16"-1"-3/16" (4.8-25.4-4.8mm)					
MT4504P-064-127			1/4"-1/2"-1/4" (6.4-12.7-6.4mm)					
MT4504P-064-191			1/4"-3/4"-1/4" (6.4-19.1-6.4mm)					
MT4504P-064-254	1/4"-1"-1/4" (6.4-25.4-6.4mm)							
MT4506P-064	6	12	1/4" (6.4mm)					
MT4506P-085			1/3" (8.5mm)					
MT4506P-095			3/8" (9.5mm)					
MT4506P-064-191			(6.4-11.9mm)					
MT4509P-064	9	18	1/4" (6.4mm)					

\* 裝配十三之針距組, 但祇裝四根針  
Equipped with 13-Needle's Gauge Set. (Needle Clamp, Needle Plate, Feed Dog, Retainer Bar) But Equipped With 4-Needles Only.



### MT 4512P

- 十二針雙鏈式環縫筒車  
12-Needle Double Chain Stitch Machine.
- 適用於短褲、運動短褲等上帶車縫、摺布車縫用縫紉機。平鬆緊帶、環狀鬆緊帶均可使用。  
Suitable for attaching elastic tape to the waist of trunks, boxers and similar garments and also can be used for pin tucking application and suitable for attaching elastic tape to the waist of trunks, boxers and similar garments.



### MT 4513P

- 十三針雙鏈式環縫筒車  
13-Needle Double Chain Stitch Machine.
- 適用於短褲、運動短褲等上帶用縫紉機。平鬆緊帶、環狀鬆緊帶均可使用。  
Suitable for attaching elastic tape or line tapes to the sports pants or jackets and similar garment and suitable for attaching elastic tape to the waist of trunks, boxers and similar garments.



### MT 4517P









- 十七針雙鏈式環縫筒車  
17-Needle Double Chain Stitch Machine.
- 多用途縫紉機針幅最大達57.2mm(2 1/4 inches)針數可在1針及17針間任選。  
Versatile machine for Various applications, 1 to 17 needles can be used with up to 57.2mm (2 1/4 inches) needles space.



### MT 4523P

- 二十三針雙鏈式環縫筒車  
23-Needle Double Chain Stitch Machine.
- 多用途縫紉機針幅最大達69.9mm(2 3/4 inches)針數可在1針及23針間任選。  
Versatile machine for Various applications, 1 to 23 needles can be used with up to 69.9mm (2 3/4 inches) needles space.



								OPTIONAL DEVICE
MT4512P-048 MT4512P-064 MT4512P-050	12	24	3/16" (4.8mm) 1/4" (6.4mm) 5mm	1.4~3.6	12	#11 ? #14	4000	●AL004 ●TB004 ●PT001 ●PS001 ●PMD ●PSM ●PSSM
* MT4513P-032 MT4513P-064	13	24	Multi-needle distance 1/4" (6.4mm)	1.4~3.6	12	#11 ? #14	4000	●AL004 ●TB004 ●PMD
MT4517P-032	17	24	1/8" (3.2mm)					
* MT4523P-032	23	24	1/8" (3.2mm)					

\* 裝配十二針縫線張力控制組, 二十四之線架六根針  
Equipped with 12-Needle's Tension Disc Set, 24-Thread Stand And 6 Needles.



### MT 4525P

- 二十五針雙鏈式環縫筒車  
25-Needle Double Chain Stitch Machine.
- 多用途縫紉機針幅最大達152.4mm (6 inches)針數可在1針及25針間任選。  
Versatile machine for Various applications, 1 to 25 needles can be used with up to 152.4mm (6 inches) needles space.

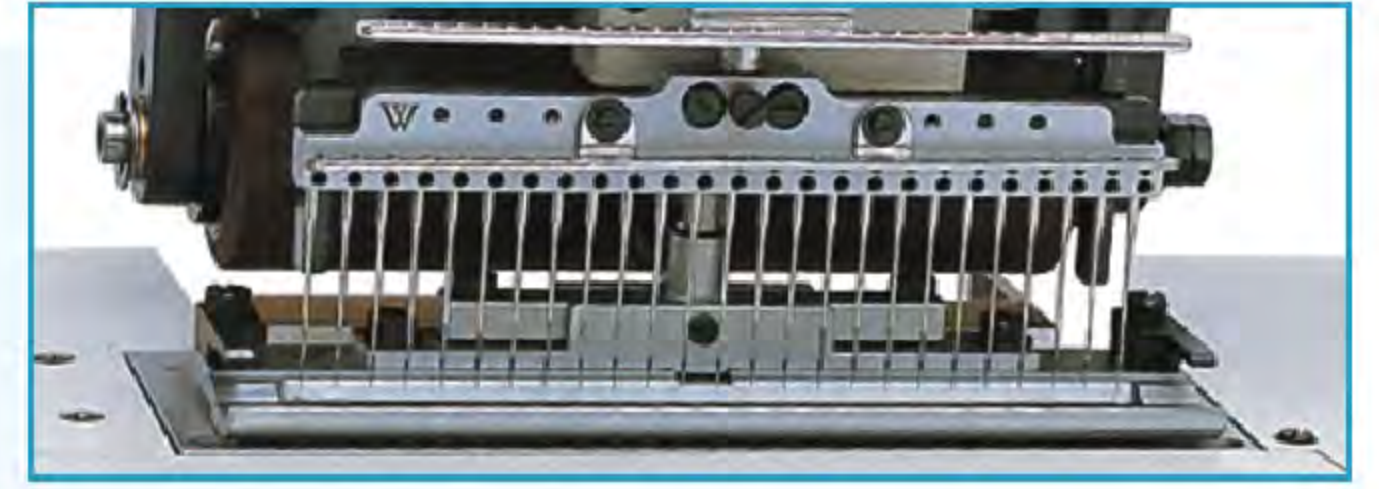

### MT 4533P

- 三十三針雙鏈式環縫筒車  
33-Needle Double Chain Stitch Machine
- 多用途縫紉機針幅最大達152.4mm (6 inches)針數可在1針及33針間任選。  
Versatile machine for Various applications, 1 to 33 needles can be used with up to 152.4mm (6 inches) needles space.



### MT PSM



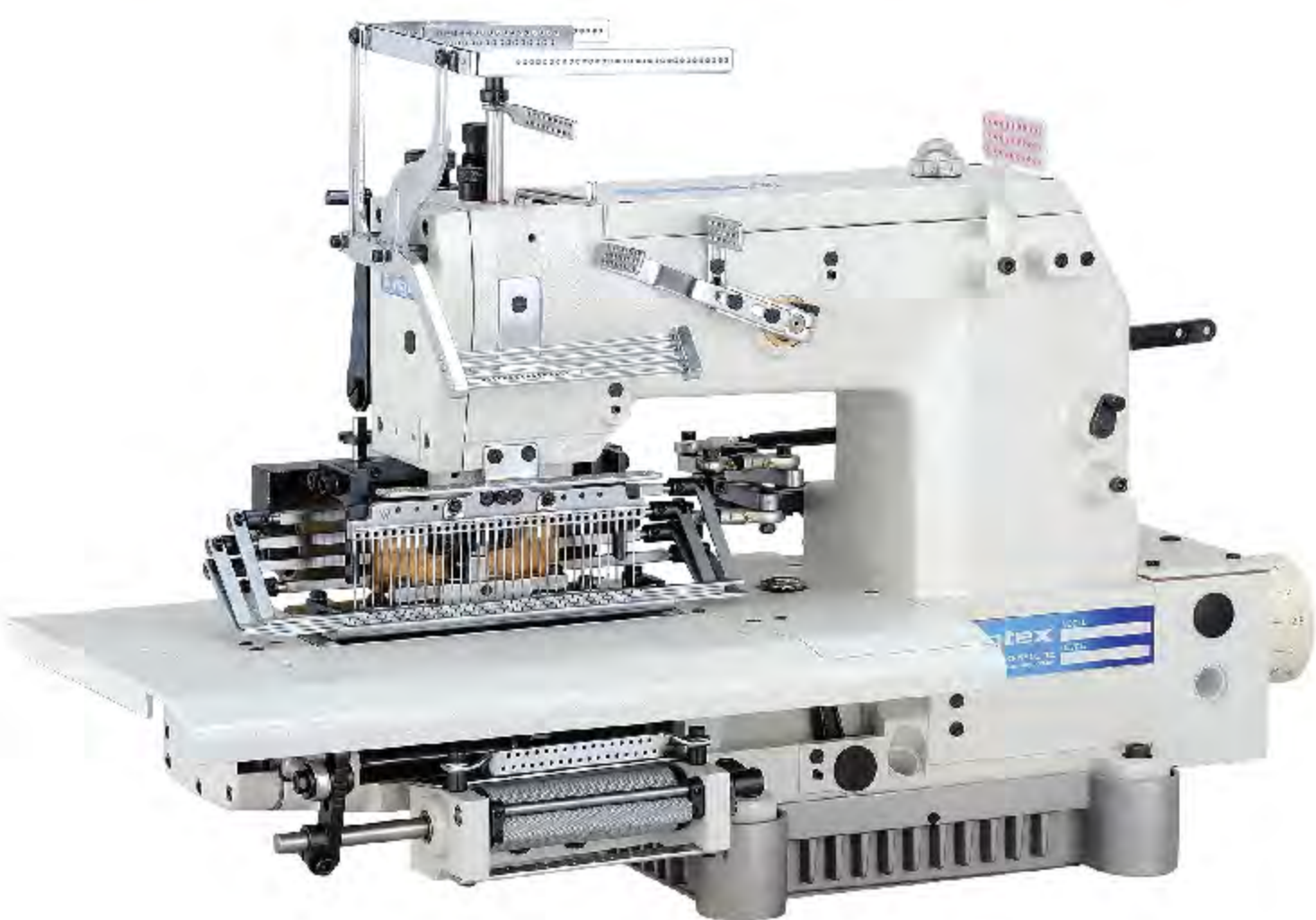
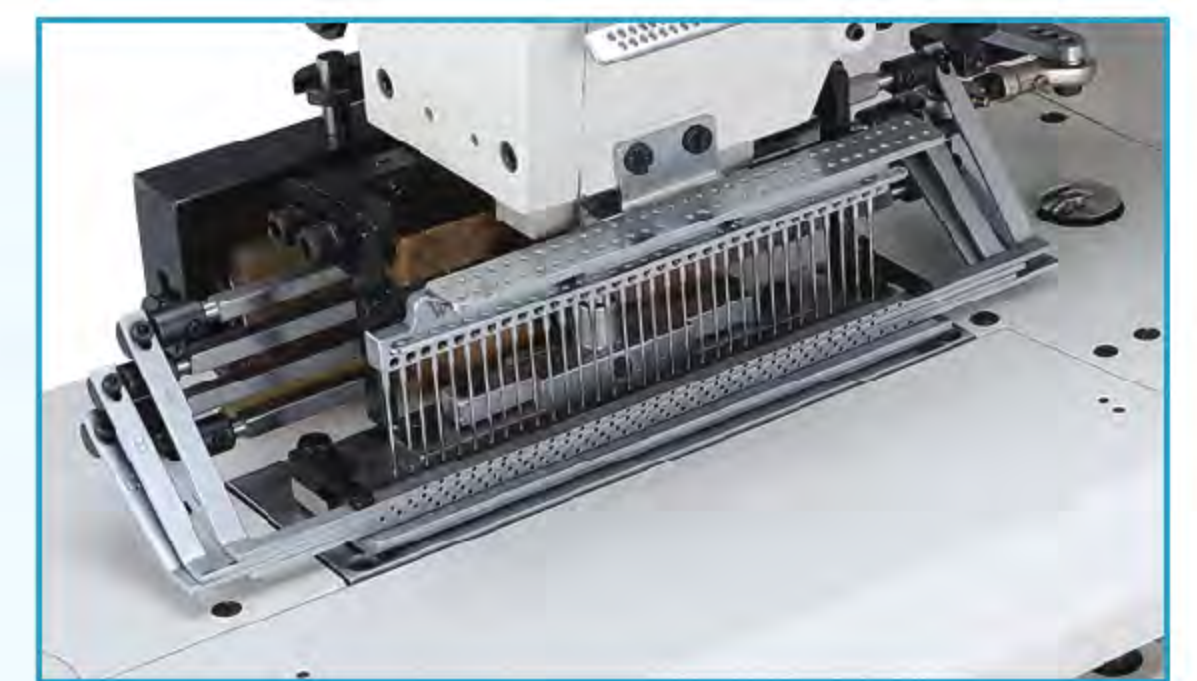



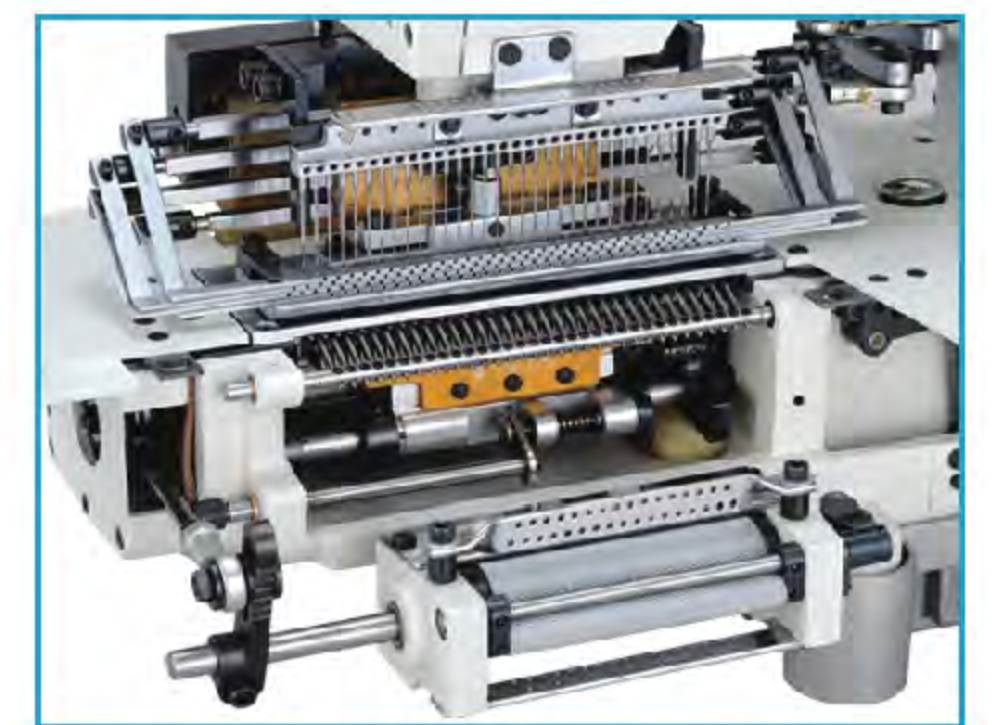

- 正面裝飾刺紡繡線跡目前有40種凸輪,可縫各種圖案,帶普通針線,普通彎針線。  
Machine for smocking, equipped with 40 different types of cams to sew various kinds of designs, with normal needle thread and normal looper thread.



### MT PSSM

- 正面裝飾刺紡繡線跡目前有40種凸輪,可縫各種圖案,帶普通針線,橡筋彎針線,帶前滾輪。  
Machine for smocking, equipped with 40 different types of cams to sew various kinds of designs, with normal needle thread, elastic looper thread and PMD.



								OPTIONAL DEVICE
MT4525P0-032	25	50	1/8" (3.2mm)	1.4~3.6	12	#11~#14 (UO113)	1500	●PMD ●PSM ●PSSM
MT4525P0-064			1/4" (6.4mm)					
MT4533P0-048			3/16" (4.8mm)					
MT4512P0-064/PSM	12	24	1/4" (6.4mm)	1.4~3.6	12	#14~#18 (DV57)	1500	
MT4516P0-048/PSM	16	32	3/16" (4.8mm)				1500	
MT4525P0-064/PSM	25	50	1/4" (6.4mm)				1500	
MT4533P0-048/PSM	33	66	3/16" (4.8mm)				1500	
MT4538P0-064/PSM	38	76	1/4" (6.4mm)				1000	
MT4550P0-048/PSM	50	100	3/16" (4.8mm)				1000	
MT4512P0-064/PSSM	12	24	1/4" (6.4mm)	1.4~3.6	12	#14~#18 (DV57)	1500	
MT4516P0-048/PSSM	16	32	3/16" (4.8mm)				1500	
MT4525P0-064/PSSM	25	50	1/4" (6.4mm)				1500	
MT4533P0-048/PSSM	33	66	3/16" (4.8mm)				1500	
MT4538P0-064/PSSM	38	76	1/4" (6.4mm)				1000	
MT4550P0-048/PSSM	50	100	3/16" (4.8mm)				1000	



### MT 4550P

- 五十針雙鏈式環縫筒車  
50-Needle Double Chain Stitch Machine
- 多用途縫紉機針幅最大達235.2mm (9 1/16 inches) 針數可在1針及50針間任選。  
Versatile machine for Various applications, 1 to 50 needles can be used with up to 235.2mm (9 1/16 inches) needles space.

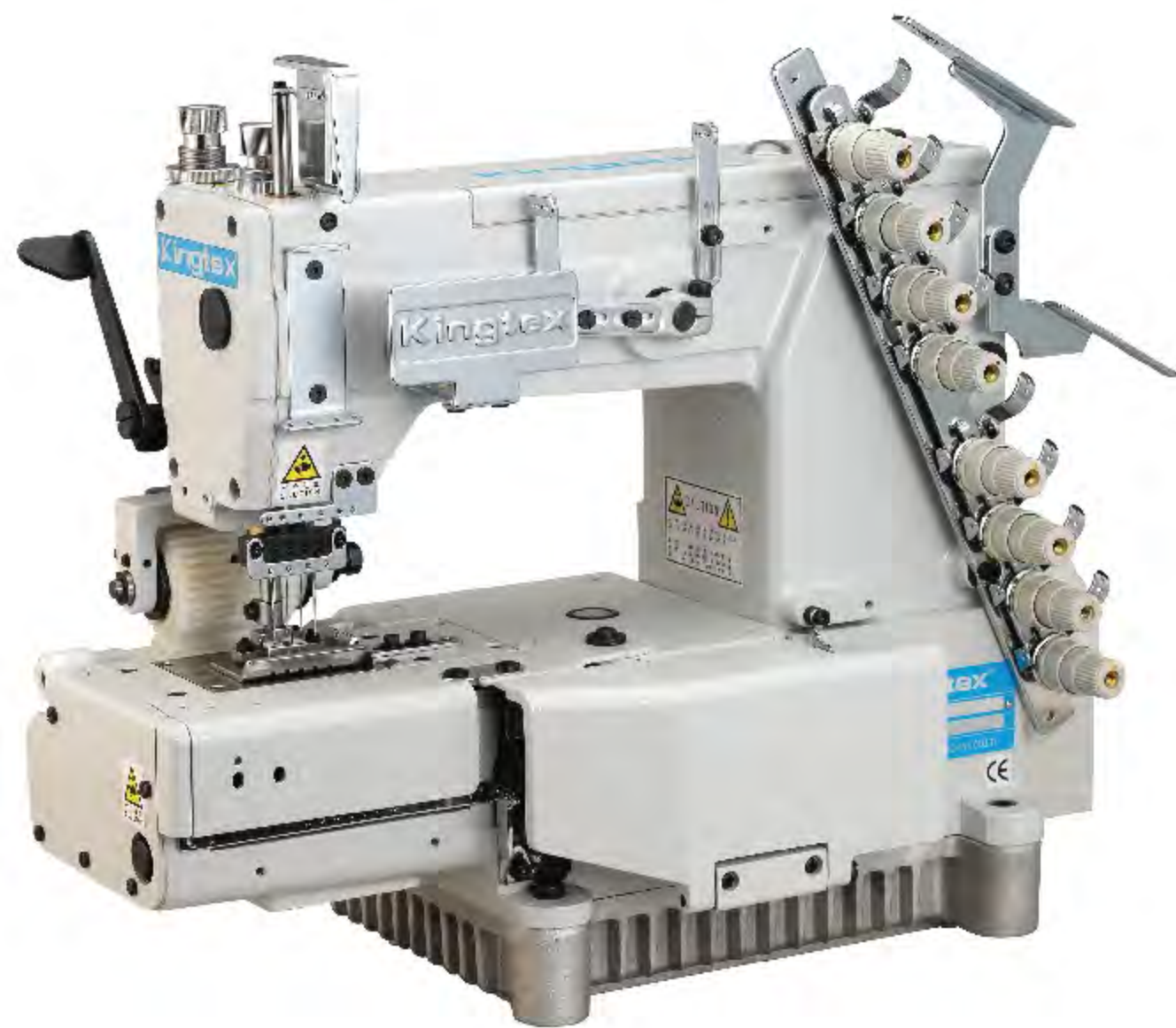
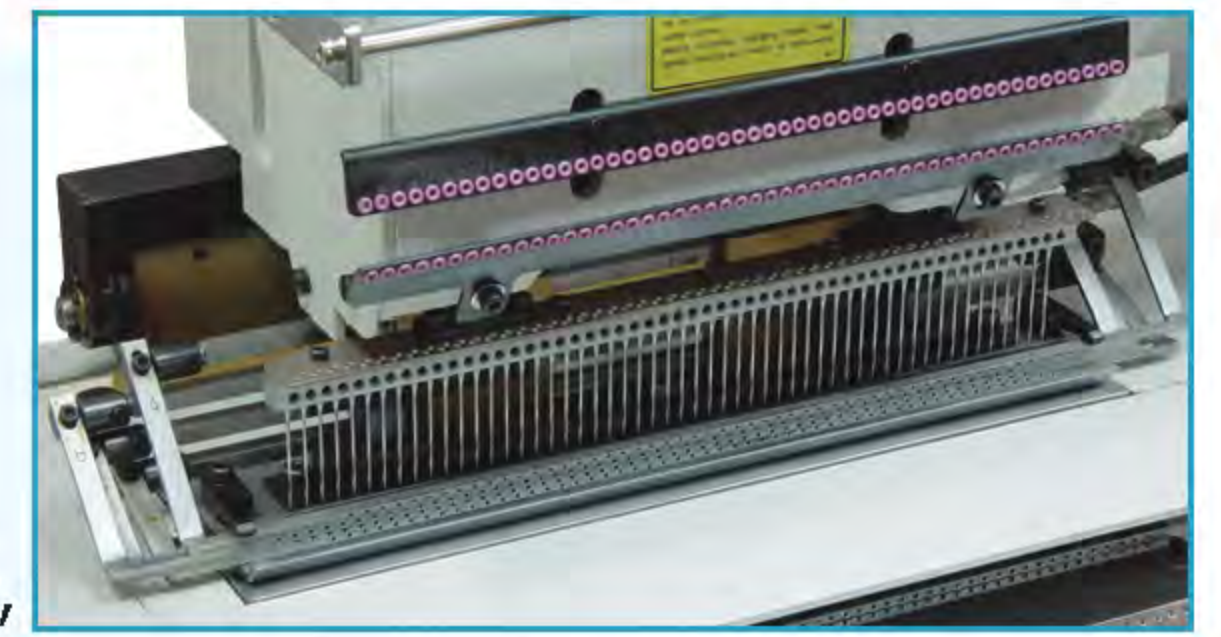

### MT MTS



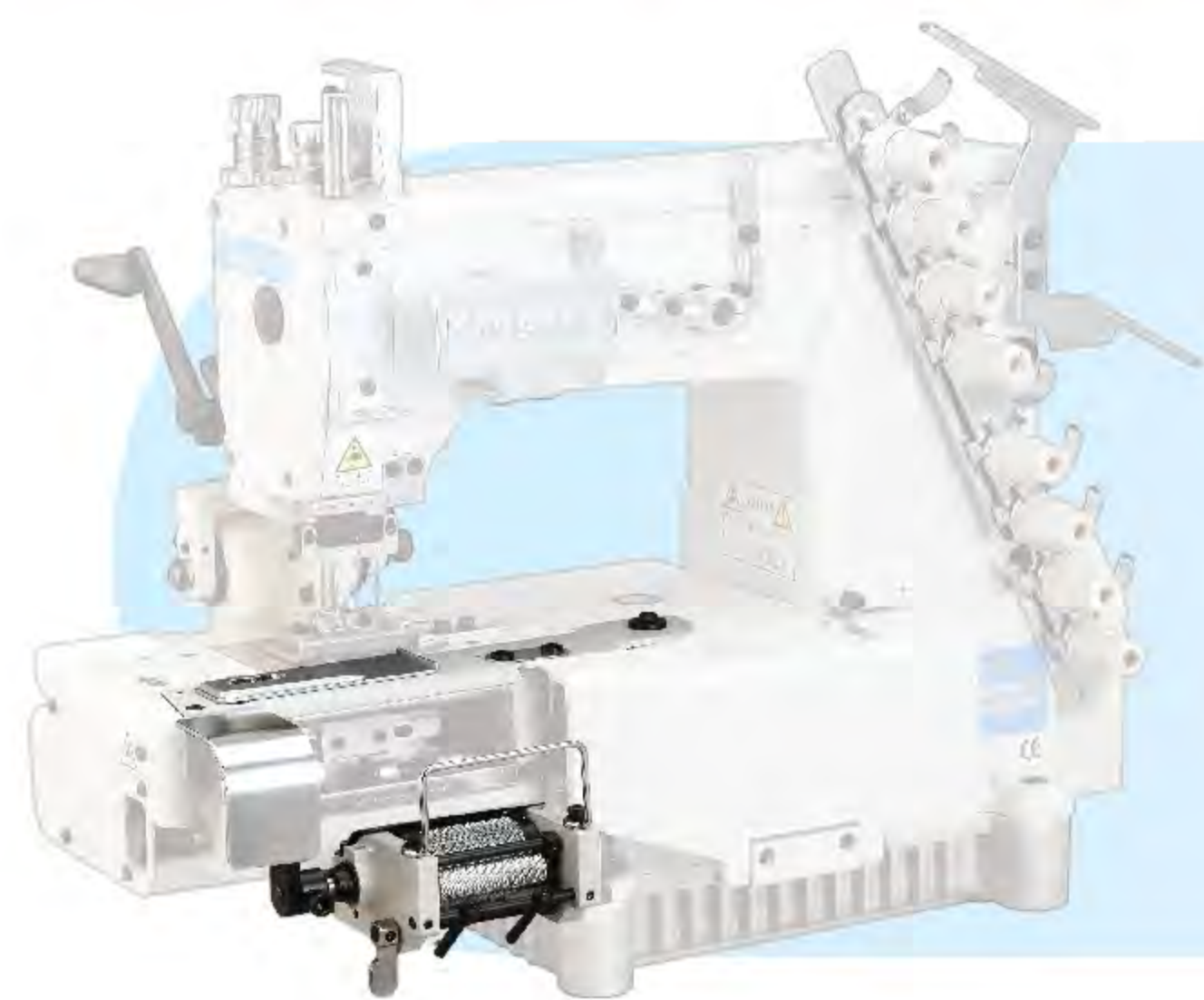
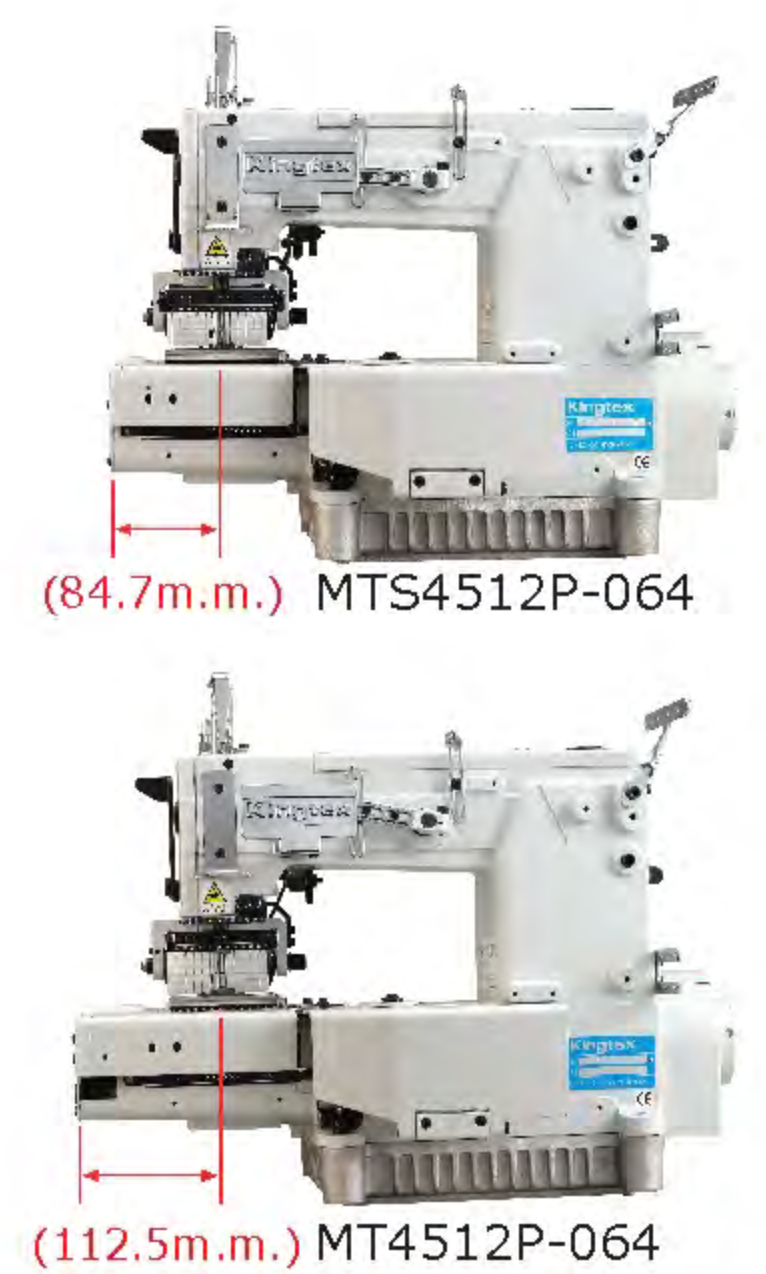



- 多針雙鏈短筒型環縫車  
Short Cylinder Bed Multi-Needle Double Chain Stitch Machine.
- 適合於童裝短褲、褲底較淺之環狀鬆緊帶車縫。  
Suitable for children's pants or the pants with low cut waist.

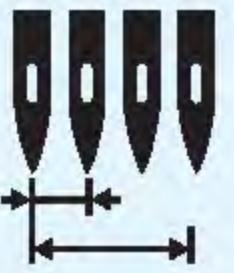

### MT PMD

- 鬆緊帶車縫  
Elastic Tape Inserting Attaching.
- 適用於短褲、運動短褲等褲頭車縫。  
Suitable for attaching elastic waistband to trunks or boxers, sports pants etc.
- PMD01: 壓花滾輪  
Knurl roller.
- PMD02: 平輪無壓花供PS01用  
With plain roller, using together with PS01.



								OPTIONAL DEVICE
MT4550P0-048	50	100	3/16" (4.8mm)	1.4~3.6	12	#12~#14	900	●PMD ●PSM ●PSSM
* MTS4504P	4	8	所有標準針距皆可用 Can be equipped with all standard specifications of needle distance.	1.4~3.6	12	#11 ? #14	4000	●AL004 ●TB004
* MTS4506P	6	12						
* MTS4509P	9	18						
* MTS4512P	12	24						
* MTS4513P	13	26						
* MTS4517P	17	34						
* MTS4523P	23	46						
** MT4504P-□□□/PMD	4	8	所有標準針距皆可用 Can be equipped with all standard specifications of needle distance.	1.4~3.6	12	#11 ? #14	3500	●AL004
** MT4506P-□□□/PMD	6	12						
** MT4509P-□□□/PMD	9	18						
** MT4512P-□□□/PMD	12	24						
** MT4513P-□□□/PMD	13	26						
** MT4517P-□□□/PMD	17	34						
** MT4523P-□□□/PMD	23	46						

\* PMD 鬆緊帶車縫不適用  
Not Suitable For PMD.

\*\* MTS 短筒環縫車不適用  
Not Suitable For MTS Series.



### MT 4004P

- 四針單鏈式環縫筒車  
4-Needle Single Chain Stitch Machine
- 適用女裝的裝飾縫。  
Suitable for decorative stitching on women's clothes.



### MT 4006P







- 六針單鏈式環縫筒車  
6-Needle Single Chain Stitch Machine
- 適用女裝的裝飾縫。  
Suitable for decorative stitching on women's clothes.

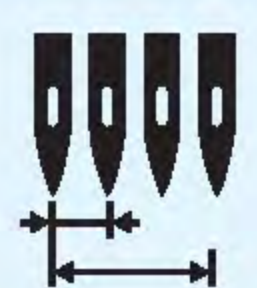

### MT 4012P

- 十二針單鏈式環縫筒車  
12-Needle Single Chain Stitch Machine
- 適用女裝的裝飾縫。  
Suitable for decorative stitching on women's clothes.



								OPTIONAL DEVICE
MT4004P-064			3/4 (18.8mm)					
MT4004P-085			1 (25.4mm)					
MT4004P-095	4	4	1-1/8 (28.6mm)	1.4~3.6	12	#11	3500	●AL004
MT4004P-106			1-1/4 (31.7mm)					
MT4004P-127			1/1/2 (38.1mm)					
MT4006P0-064			1/4" (6.4mm)					
MT4006P0-085	6	6	1/3" (8.5mm)					
MT4006P0-095			3/8" (9.5mm)					
MT4012P0-048			3/16" (4.8mm)	1.4~3.6	12	#11	3500	●AL004 ●PSM ●PSSM
MT4012P0-064	12	12	1/4" (6.4mm)					
MT4012P0-050			5mm					



#### MTD UT

- 氣動式自動切線裝置(多針雙鏈式環縫筒車)。  
Pneumatic Type Under Bed Thread Trimming System (For Multi-Needle Double Chain Stitch Machines).

#### 特點 Feature

- 本裝置可適用於所有MTD4500系列機種，但不單獨供應此裝置。  
Suitable for all MTD4500 Series Machines, but only supply together with Machine head.
- 須配合伺服馬達使用或電子馬達  
Should be used together with AC servo motor or EC motor.
- 須配合空壓機使用，(6kg / cm 或70PSI)。  
Compressed air is necessary (6kg / cm or 70PSI) .



AL004  
氣動式壓腳昇器  
Pneumatic Presser Foot Lifter



UT12A  
切底線裝置  
Under bed thread trimmer

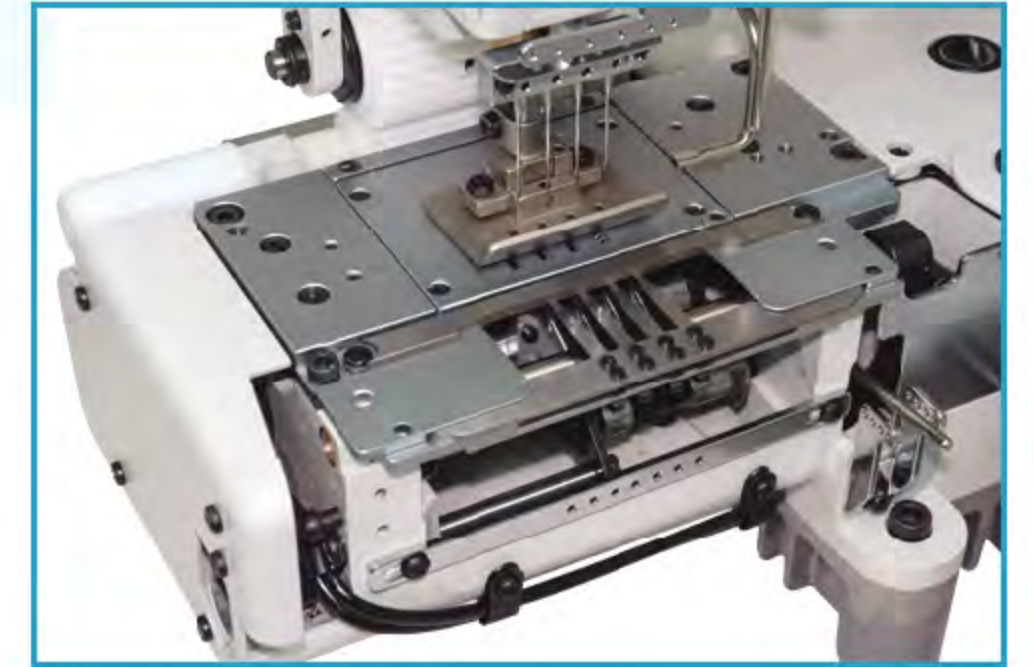

UT04A  
切底線裝置  
Under bed thread trimmer



撥線裝置  
Air wiper



UT12A  
鬆線組  
Thread Tension Set



UT12A  
鬆線組  
Thread Tension Set



MTD4500  
直驅式馬達  
Direct drive servo motor

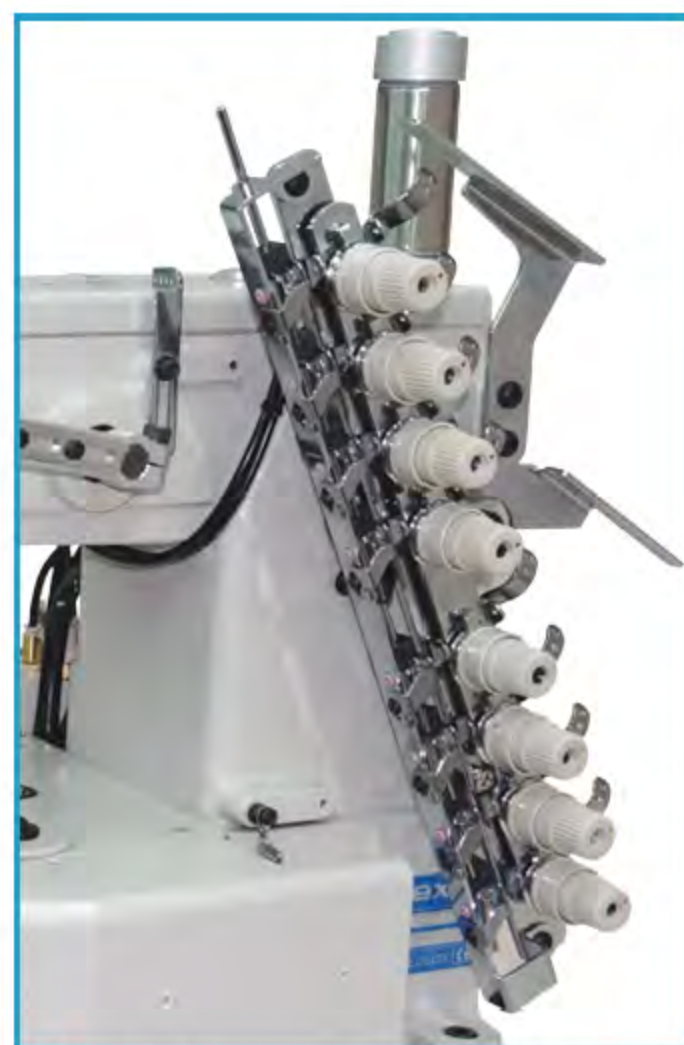

UT04A  
鬆線組  
Thread Tension Set



TL002  
LED 燈  
LED Light ASM

<b>UT 04 A</b> <b>① ② ③</b>	<b>①</b> 自動切線裝置代號 <b>②</b> 針數 04:4針 06:6針 12:12針 23:23針	<b>①</b> Under bed thread trimmer device <b>②</b> Number of Needle : 04:04-Needle 06:06-Needle 12:12-Needle 23:23-Needle
	<b>③</b> 針距 A: 1/4" (6.4mm) B: 1/3" (8.5mm) C: 3/8" (9.5mm) D: 5/12" (10.6mm) S: 1/8" (3.2mm)	<b>③</b> Needle Distance Code A: 1/4" (6.4mm) B: 1/3" (8.5mm) C: 3/8" (9.5mm) D: 5/12" (10.6mm) S: 1/8" (3.2mm)





**MT PS01A** (1/4", 6.4mm)  
**PS01B** (3/16", 4.8mm)

- 鬆緊線抽皺縫  
Elastic Thread Shirring
- 適用於女性流行服飾或束腰。  
Suitable for ladies fashion wear.

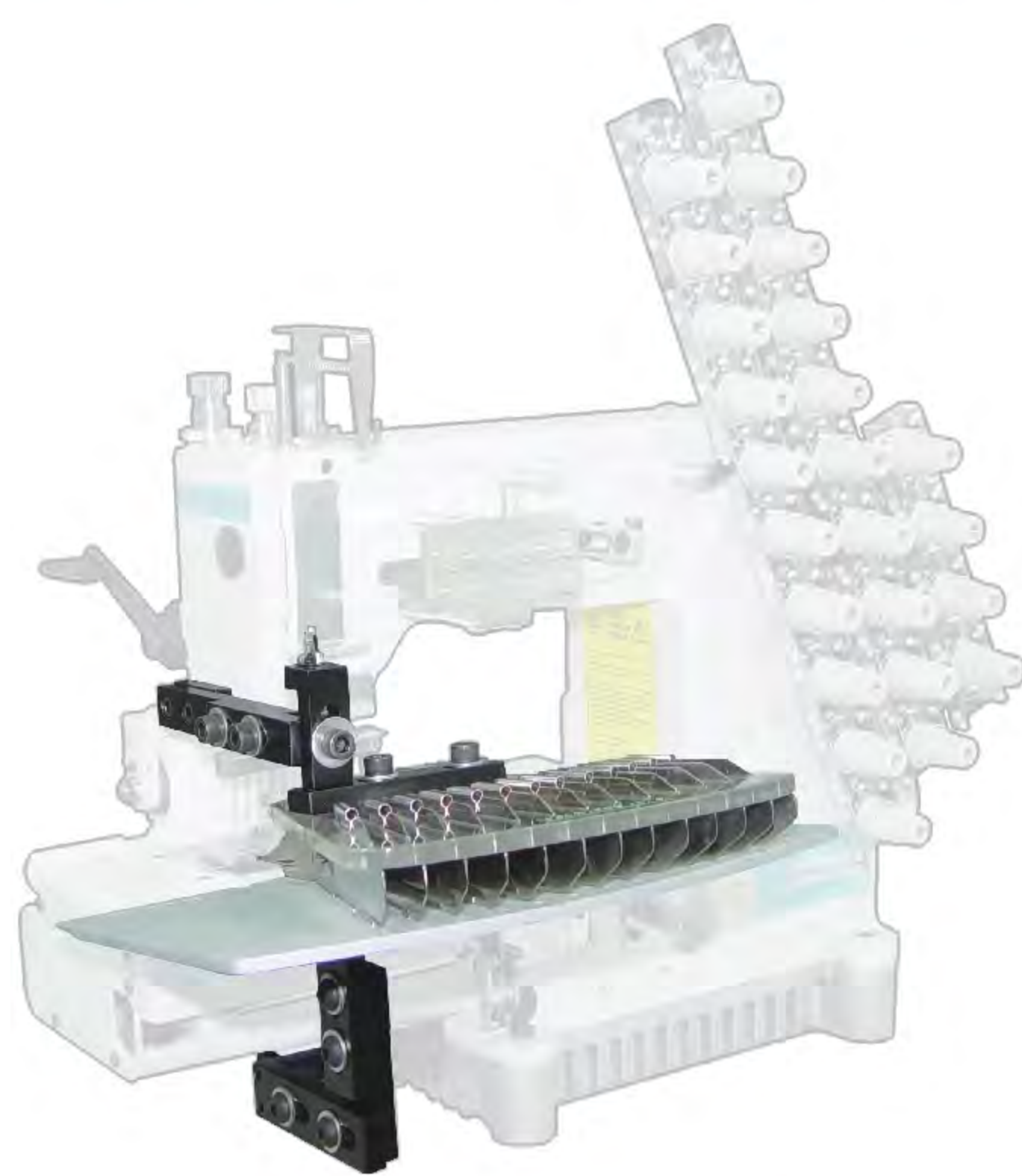
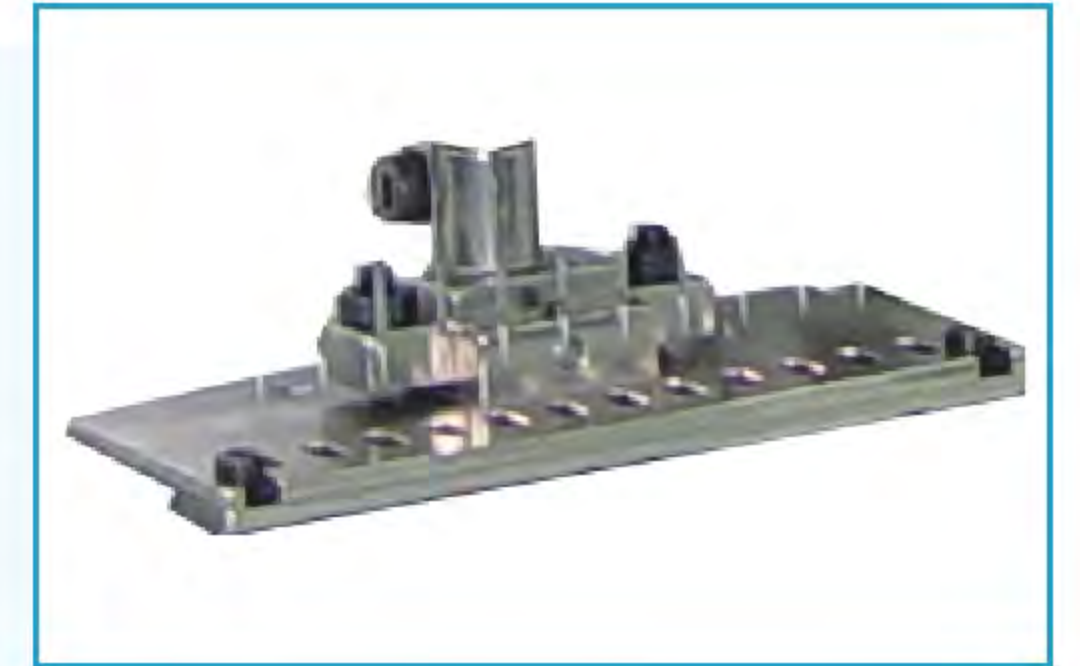

**MT PT001**



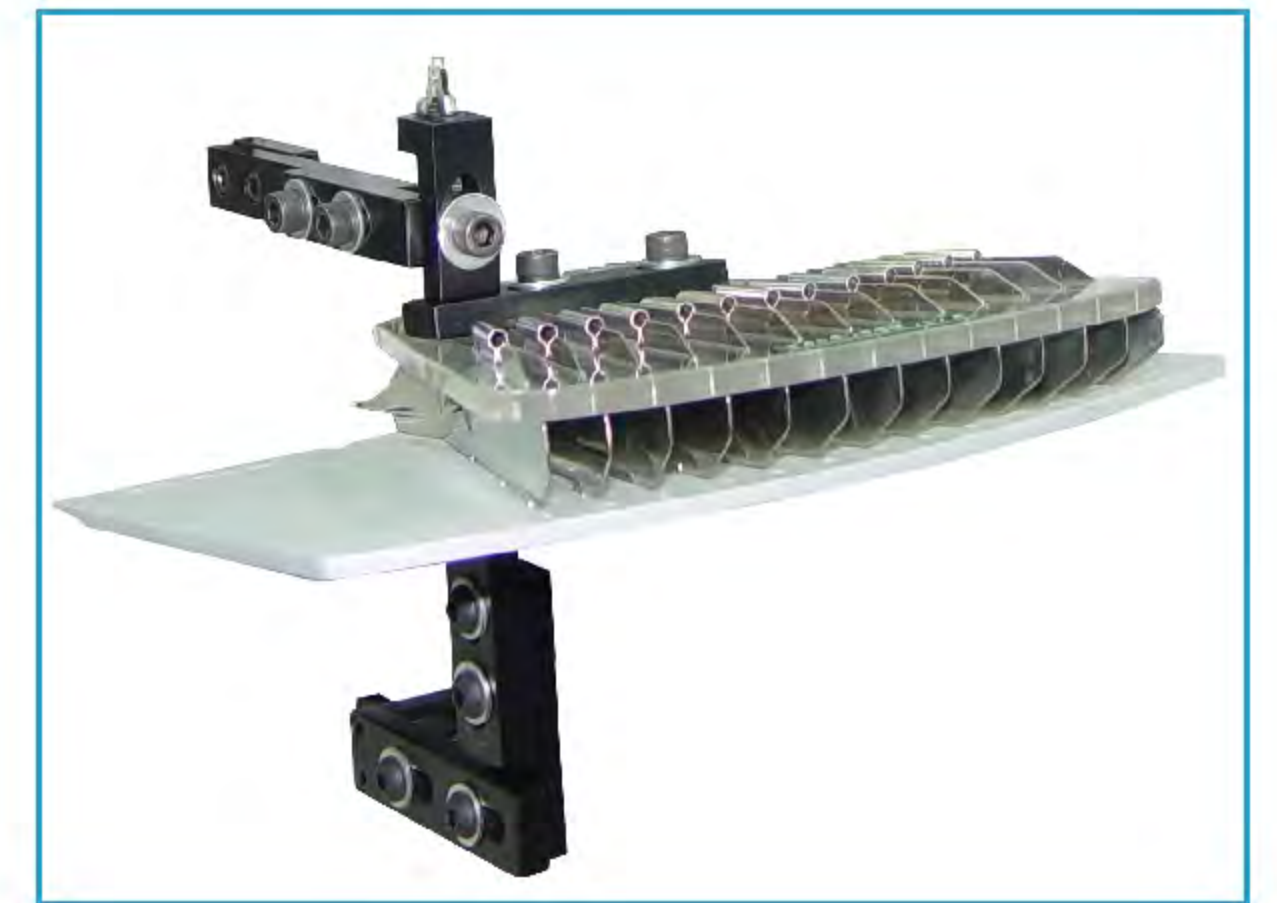



- 摺布車縫裝置。  
Pin Tucking.
- 適用於摺布車縫。  
Suitable for men's tuxedo shirts etc.

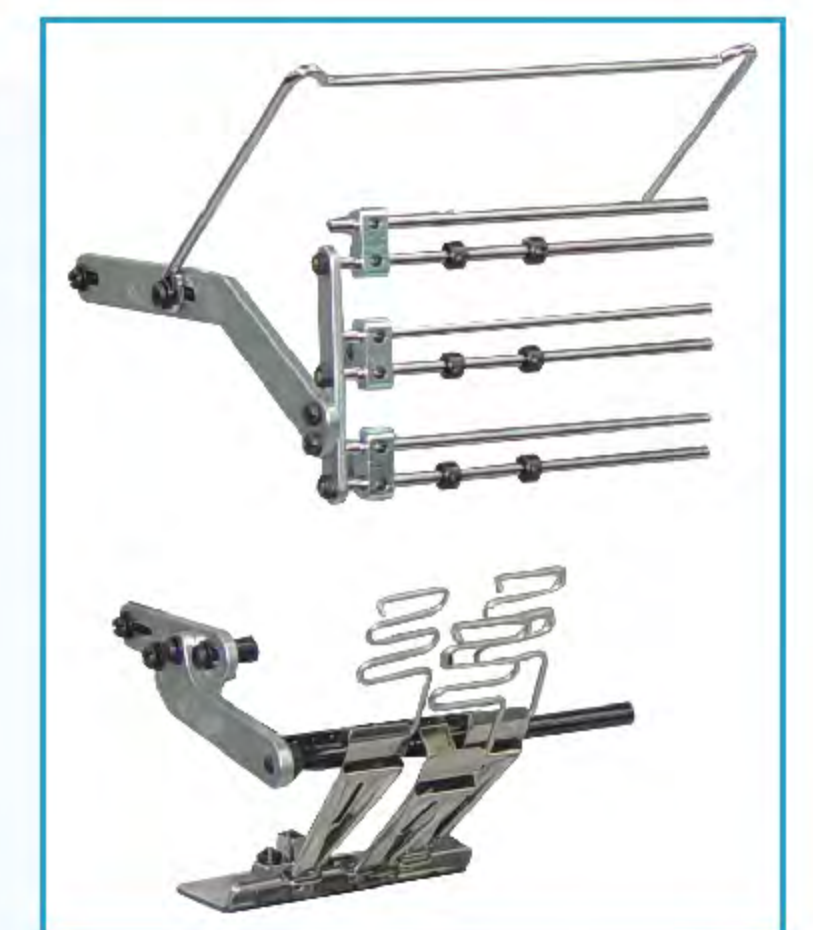

**MT TB004**

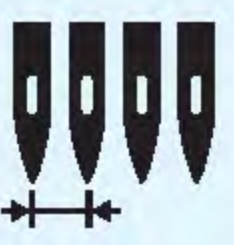
- 上帶補強帶車縫  
Reinforcing Tape Attaching.
- 適用於運動褲、運動衫、休閒服。  
Suitable for attaching line stripes on sports pants or sports jackets etc.



								OPTIONAL DEVICE
				m.m.	m.m.	U0113	S.P.M.	
MT4512P0-064/PS01A	12	24	1/4" (6.4mm)	1.4~3.6	12	#11~#14	3500	●AL004
MT4512P0-064/PS01B			3/16" (4.8mm)					
MT4512P0-048/PT001	12	24	3/16" (4.8mm)	1.4~3.6	12	#11~#14	2000	●AL004
MT4512P0-064/PT001			1/4" (6.4mm)					
MT4512P0-048/TB004	12	24	3/16" (4.8mm)	1.4~3.6	12	#11~#14	3500	●AL004
MT4512P0-064/TB004			1/4" (6.4mm)					

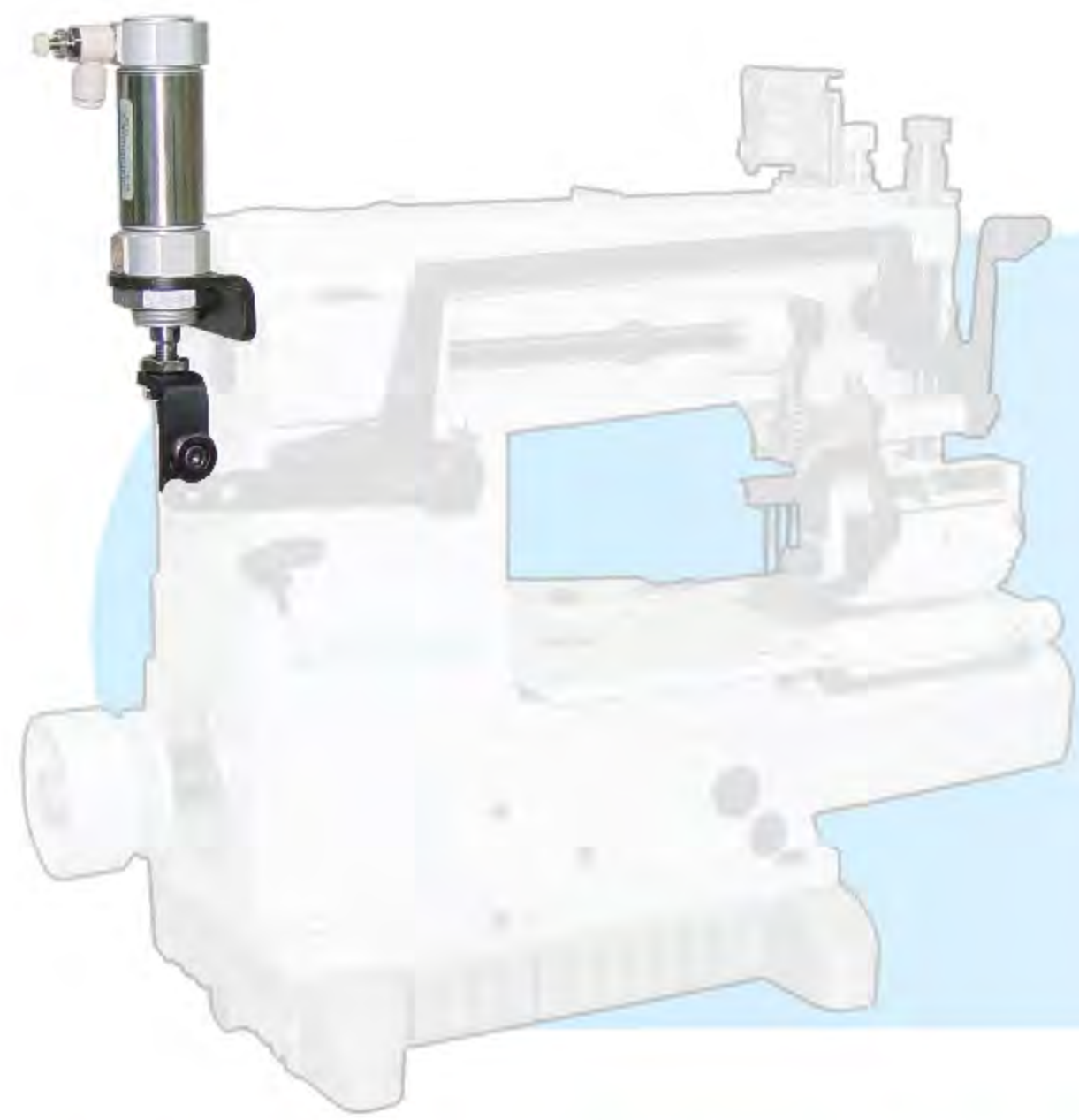

### MT AL004

- 氣動式壓腳昇器  
Pneumatic Presser Foot Lifter.
- 適用全 MT4500 MT4000 系列, 省力裝置。  
Labor - Saving Device, Suitable For All MT-4500, MT-4000 Series.



### MTD TCB41







- 氣動式切帶裝置(多針雙鏈式環縫筒車)  
Pneumatic Type Tape Cutting Device  
(For Multi-Needle Double Chain Stitch Machines).
- 適用蕾絲帶、鬆緊帶、滾條補強帶。  
Suitable For Cutting Lace, Elastic Tape, Binding Tape, Reinforcement Tape etc.
- 可切寬度：80m.m.(最大值)。  
Cutting Width：80m.m. (Max).

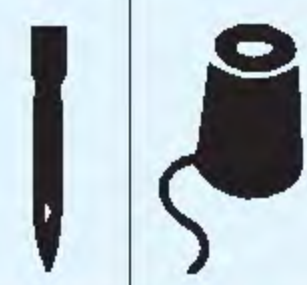

### MTD TCS41

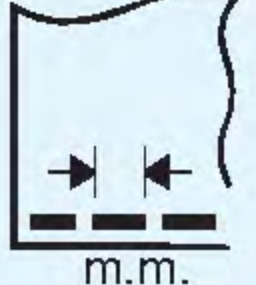
- 氣動式切帶裝置(多針雙鏈式環縫筒車)  
Pneumatic Type Tape Cutting Device  
(For Multi-Needle Double Chain Stitch Machines).
- 適用鬆緊帶。  
Suitable For Cutting Elastic Tape.



			 m.m.	 m.m.	 U0113	 S.P.M.	OPTIONAL DEVICE
MT40□□P-□□□/AL004 MT45□□P-□□□/AL004	-	-	-	12	-	-	-
MTD45□□P-□□□/TCB41	-	-	-	12	-	-	-
MTD40□□P-□□□/TCS41 MTD45□□P-□□□/TCS41	-	-	-	12	-	-	-