

○ 機型編號說明

○ MODEL NUMBERING

**UHD90** □ □ **F** - □ □ □ □ - **M14** / **SS033** / □

1

2

3

4

5

6

7

8

9

10

11

12

副機型代號 /  
Application Code:  
0:基本型  
1:盲縫裝置  
2:線頭包覆裝置  
3:雙鏈縫滾邊裝置  
4:摺景裝置  
5:滾邊導模裝置  
6:包繩導模裝置  
7:摺景包繩導模裝置  
8:鬆緊帶傳送裝置  
9:補強帶傳送裝置  
A:下自動鬆緊帶包縫  
B:下捲鑷邊裝置  
C:管狀肩帶成型裝置

0:Basic Model  
1:Blind Stitching  
2:Backlatching  
3:Double Chainstitch  
4:Gathering  
5:Pocket Bags Seaming  
6:Piping  
7:Gathering and Piping  
8:Elastic Tape Attaching  
9:Reinforce Tape Sewing  
A:Auto Elastic Tape Attaching  
B:Fine Edging  
C:String Forming (Spaghetti Sewing)

機型 / Machine Type:

UHU9000:直驅式伺服馬達型平型上送鎖邊機  
Direct drive type mini servo motor flat bed top feed overlock  
UHU9100:直驅式伺服馬達型平型上送特厚鎖邊機  
Direct drive type mini servo motor flat bed top feed heavy material overlock  
UHU9300:直驅式伺服馬達筒型上送鎖邊機  
Direct drive type mini servo motor cylinder bed top feed machine  
UHF9000:平型上送鎖邊機  
Flat bed top feed overlock  
UHF9100:平型上送特厚鎖邊機  
Flat bed top feed heavy material overlock  
UHF9300:筒型上送鎖邊機  
Cylinder bed top feed machine  
UHD9000:直驅平型鎖邊機  
Direct drive flat bed overlock  
UHD9100:直驅特厚鎖邊機  
Direct drive flat bed heavy material overlock  
UHD9000:直驅筒型鎖邊機  
Direct drive cylinder bed overlock  
UH9000:平型包縫機  
Flat bed overlock  
UH9100:平型特厚包縫機  
Flat bed heavy material overlock  
UH9300:筒型鎖邊機  
Cylinder bed overlock

針距代號 /  
Needle Distance:  
0:0.  
2:2.2m.m.  
3:3.2m.m.  
5:4.8m.m.

針縫邊寬 /  
Seam Width:  
2:2.0m.m.  
3:3.0m.m.  
4:4.0m.m.  
5:5.0m.m.  
6:6.0m.m.

新型防油針棒機構及  
密封式節距按鈕  
(UH9000F, UHD9000F)  
New type needle bar design that able to prevent the oil from leaking in this needle bar area and also new push-button design can prevent oil from leaking.

針縫線數 /  
Number Of Thread:  
1:單線(Single Thread)  
2:2線(2-Thread)  
3:3線(3-Thread)  
4:4線(4-Thread)  
5:5線(5-Thread)  
6:6線(6-Thread)

線跡代號 /  
Stitching Code:  
11:#101  
41:#401  
03:#503  
04:#504  
05:#505  
12:#512  
14:#514  
15:#515  
16:#516  
42:#542  
44:#544

布料厚度 /  
Fabrics Thickness:  
F:極薄類  
M:中厚類  
X:極厚類  
L:薄類  
H:厚類  
F:Fine  
M:Medium to Heavy  
X:Extra Heavy  
L:Light  
H:Heavy

次機型代號 (UH9, UH93, UHD9, UHD93) /  
Sub-class Code :  
相同的基本規格，但因特殊用途而修改部分零件規格與基本型略有差異的機型代號，以英文字母表示。

A:寬刀  
B:角刀  
C:窄壓腳  
D:標準盲縫兩用  
E:肩帶壓腳  
F:特殊送布齒  
R:粗齒  
Same basic model but equipped with minor special parts for special applications.  
Model code marked with english alphabet letter.  
A:Wide Knife  
B:Angle Knife  
C:Narrow Presser Foot  
D:Two In One,For Both Normal And Blind Hemming Usage.  
E:Shoulder Tape Presser Foot  
F:Special Feed Dog  
R:Thick Teeth Feed Dog

送布齒列數 / Rows Of Feed-Dogs:  
1:1列(Row)  
2:2列(Rows)  
3:3列(Rows)  
4:4列(Rows)

伺服馬達  
(UHD9, UHD93, UHU9, UHU93)  
AC Servo Motor

可選擇加裝之裝置 / Optional Device:  
TC:單觸式自動切線裝置  
One Touch Type Tape Cutter  
US:下吸式自動切線  
Flat Suction Type Chain Cutter  
SS:側吸式自動切線裝置  
Side Suction Type Chain Cutter  
BH:盲縫裝置  
Blind Hemming Device  
BT:線頭夾持組與專用零件  
Thread end clamp Device  
BL:縫線張力控制組  
Thread Tension Control Device  
EF:鬆緊帶傳送裝置  
Elastic Tape Feeding Device  
GC:摺景裝置  
Gathering Device  
TB:補強帶導模  
Tape Guide Parts List  
BD:雙鎖鏈縫  
Double Chain Stitch  
EG:滾邊車縫  
Piping Sewing  
AG:角刀組  
Angled Knife Set  
FS:全沉式車板裝置  
Parts For Fully-Submerged Installation  
PFE:電控式抬壓腳裝置與相關零件  
Thread-Wipe Presser Foot Components  
MN:直驅馬達  
Liner - Motor  
TL:燈組  
LED Light Asm.  
SE:對照式電眼開關組  
Through Beam Electronic Edge Sensor Set Parts  
SBL:簡易包線頭  
Simplified Type Of Automatic Backlatcher Device  
CV:節氣式集屑裝置  
Lint Collector  
\* CV □ 8 □ :  
□ : 0 : UH9000, UHD9000  
2 : UH9300, UHD9300  
3 : UHF9000, UHU9000  
4 : UHF9300, UHU9300  
5 : UHF9000, UHU9000  
6 : UHF9300, UHU9300  
□ : A, B, C, D, E, F, G, H, I, K, M

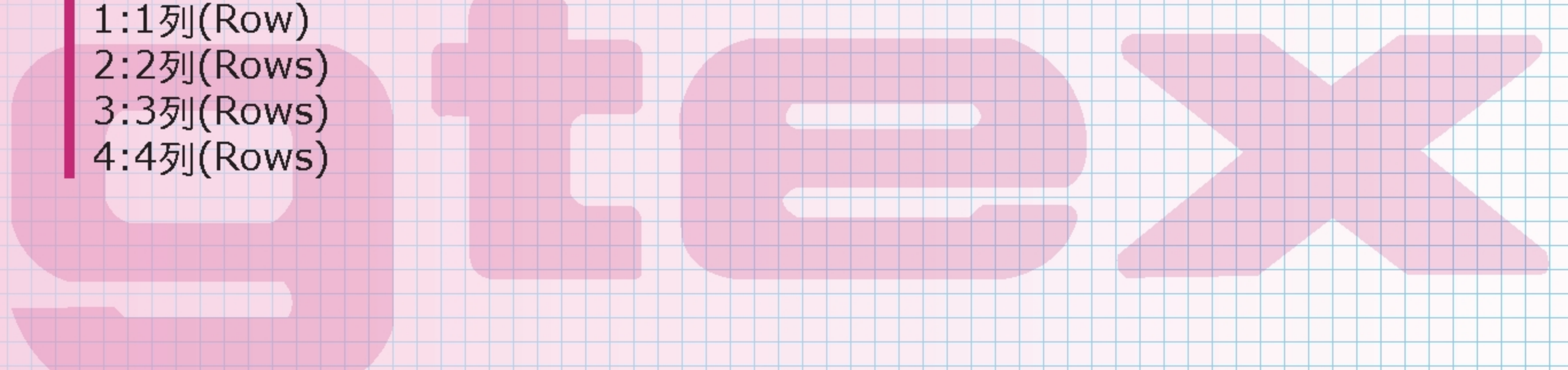



- 一般特性
- GENERAL FEATURES

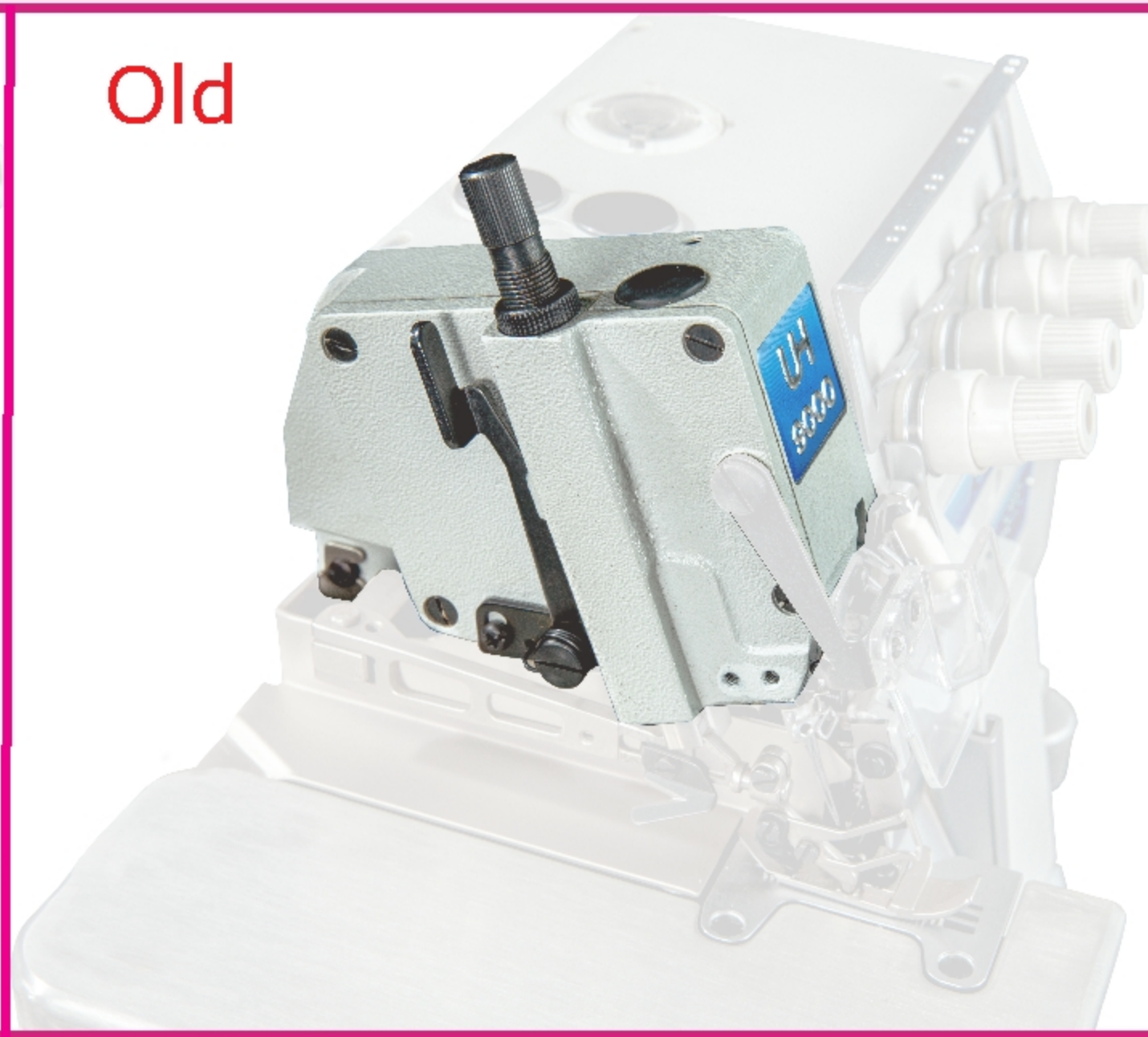

新版將調節壓腳螺椿組，整合為車頭一體，克服了舊版針棒側蓋裝配不良而產生漏油，且針棒側蓋平面化方便維修與調整。

We have modified the adjustable screw studs of pressor foot that to be integrated with machine frame itself. It will overcome the oil leaking problem due to bad assembling or uneven side cover in needle bar area. It can be adjusted and repaired more easier while the side cover of needle bar is flat on new UH9000F version.

舊版調整縫目節距之按鈕，總長70mm，過長容易產生歪斜而漏油，新版為密封式20mm長，無漏油之顧慮。

The length of 70mm for stitch adjustment push button can be skewed and causing oil leaking problem due to the longer length of this part. In new version, we reduce the length by 20mm in this new design sealed type that could prevent the oil leakage from happening totally.

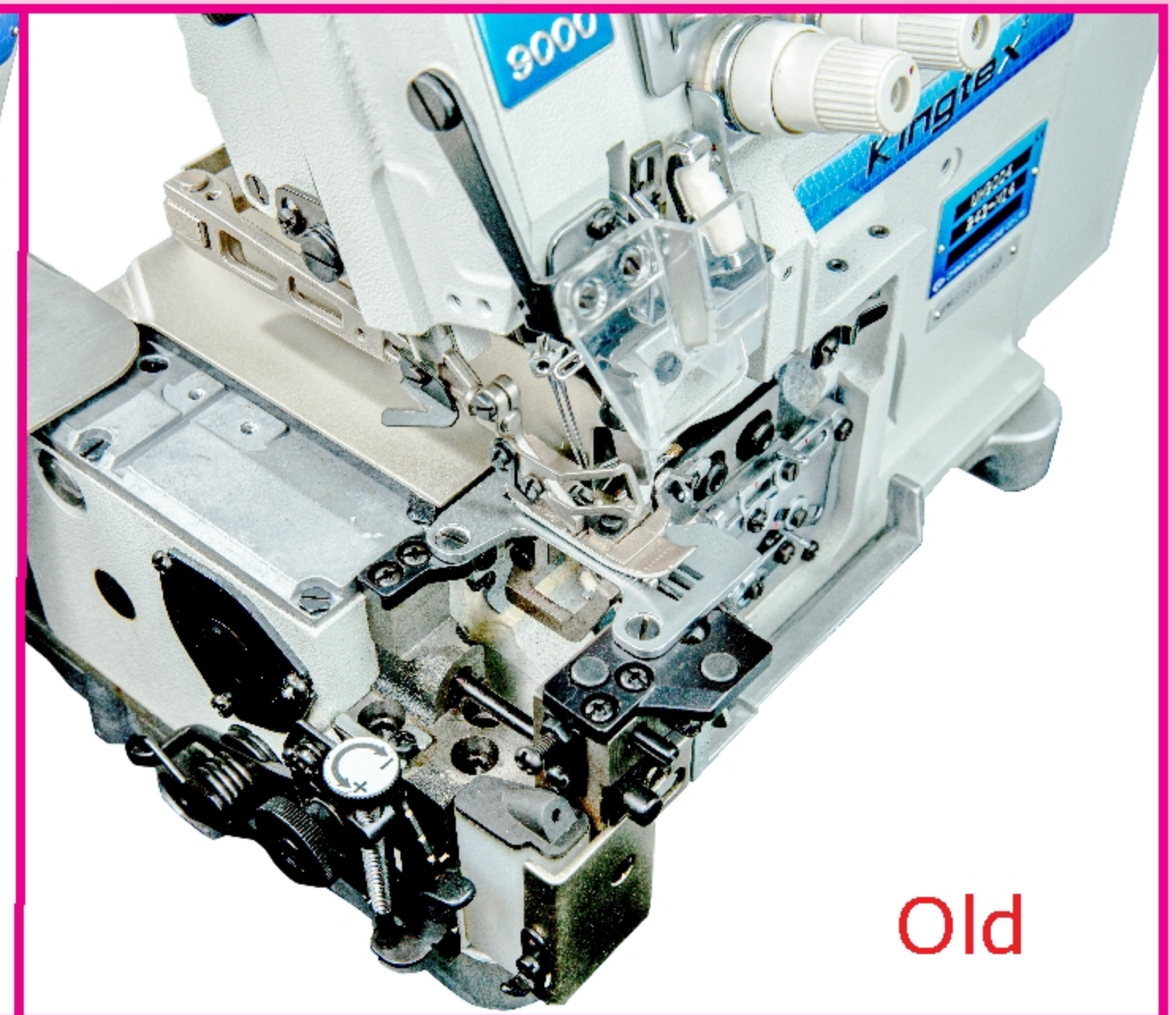
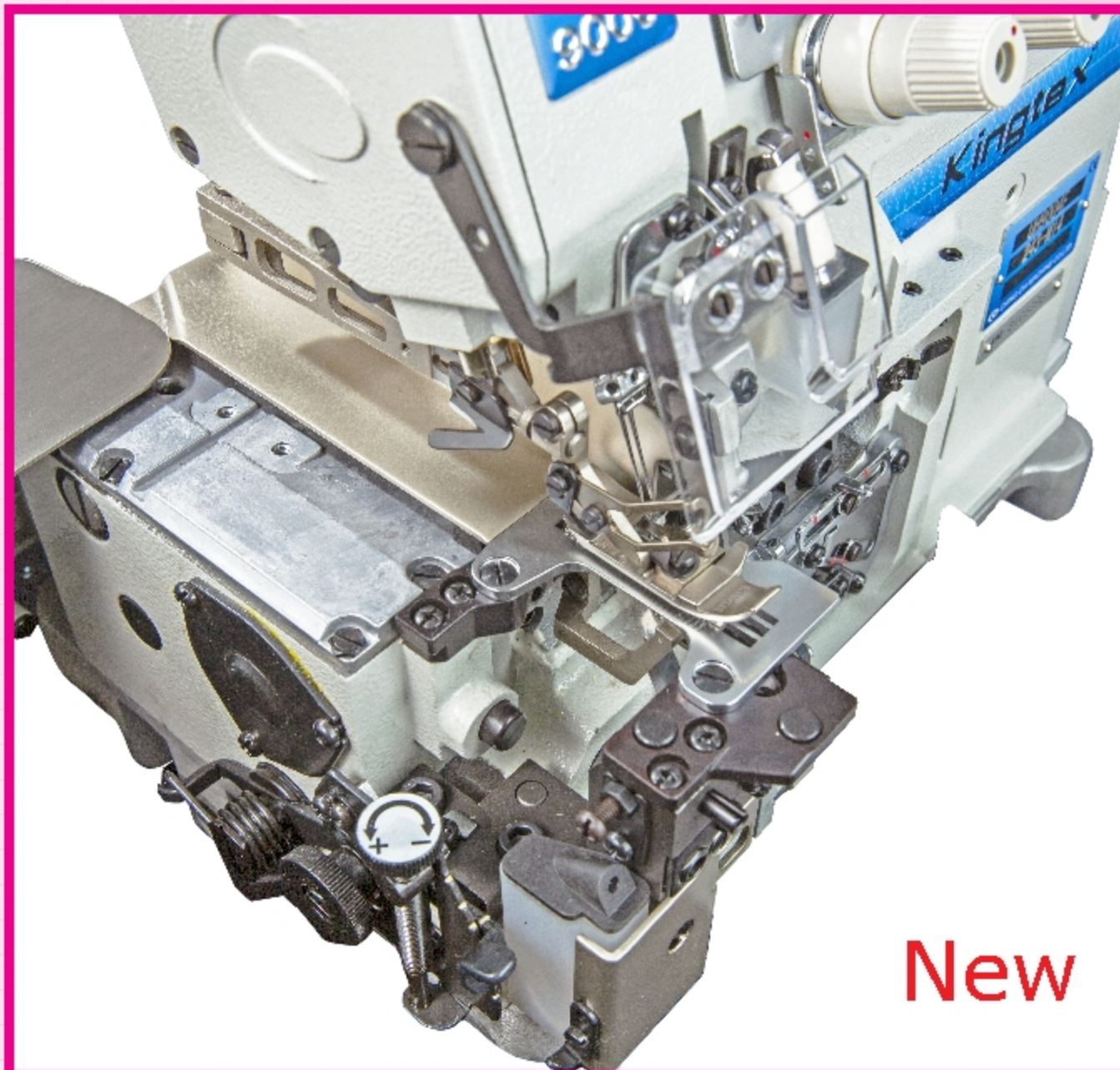

#### TC-021: 電磁式自動切刀

##### Electric one-touch type tape cutter

- 採電磁式驅動，只須輕觸開關，即可將線頭或鬆緊帶或補強帶切斷。  
Electric type tape cutter, by one touch of the switch, the chain-off thread and tape can be cut efficiently.
- 可輕易切斷 12m.m.x 0.5m.m. 鬆緊帶或補強帶。  
Can easily cut off elastic tape or reinforcing tape of 12m.m.x 0.5m.m.

#### SS-033 側吸風式自動切線刀(垂直吸風式)

##### Side suction type thread trimmer (vertical type)

線頭由側面被吸入，並由內置之刀片將之剪斷。  
The chain-off thread is trimmed by the blades, when it is been sucked in from the side behind the pressor foot.

#### US-040 下吸風式自動切線刀(水平吸風式)

##### Under suction type thread trimmer (horizontal type)

線頭向下被吸入，並由內置之刀片將之剪斷。  
When the chain-off thread is sucked in horizontally behind the needle, then, trimmed by the blades.

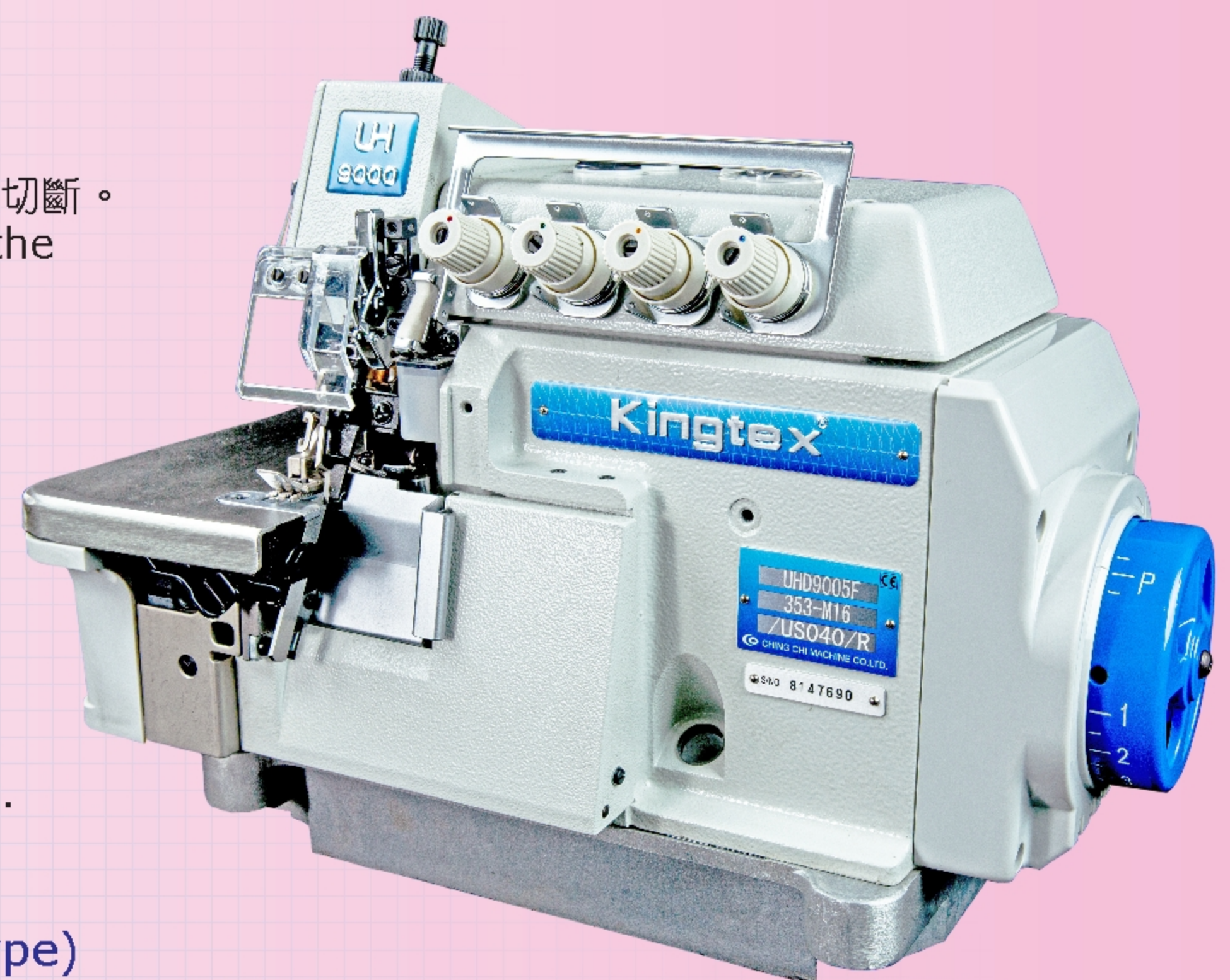

TC-021

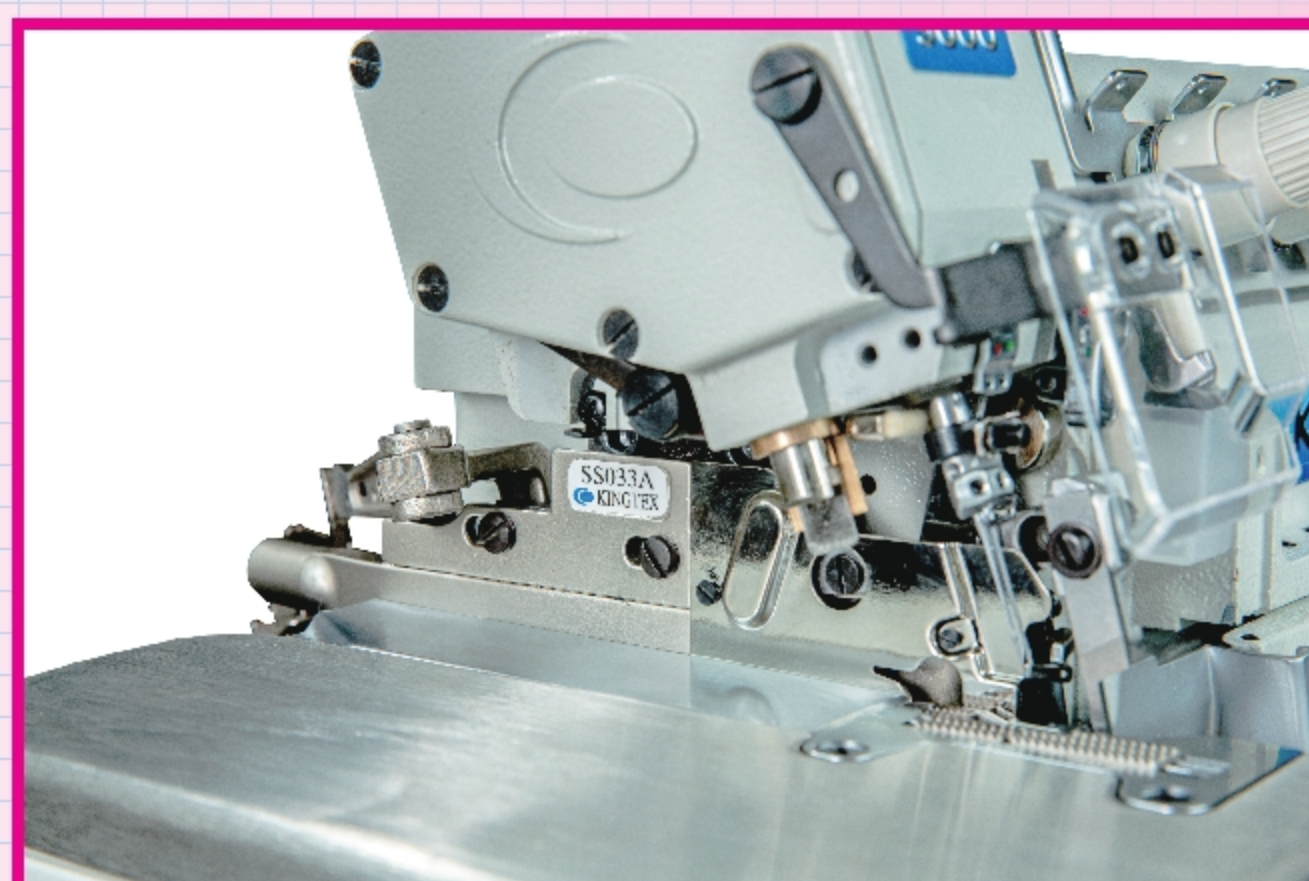

SS-033

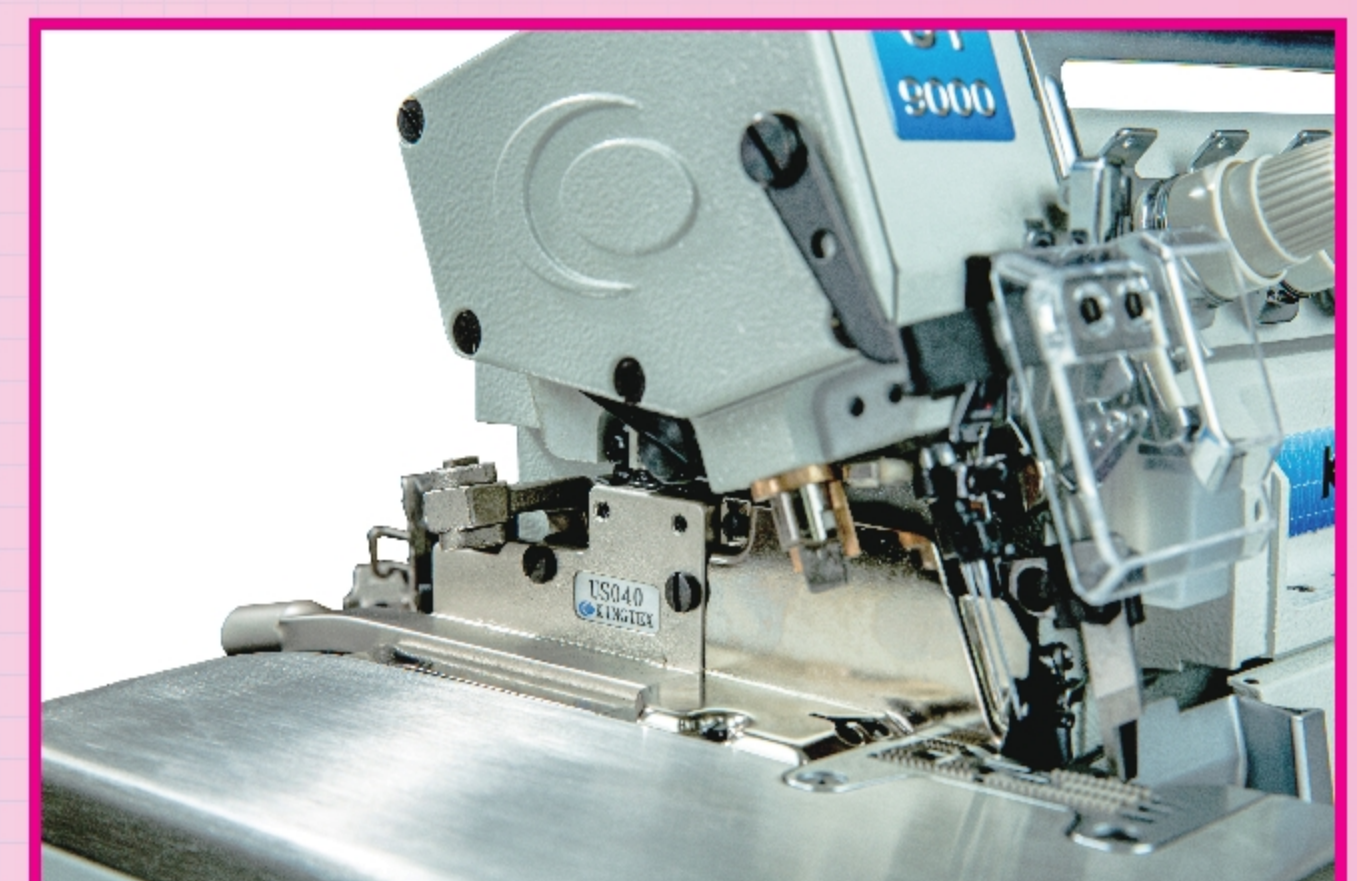

US-040





- UH 9002** (1針2線包縫機)  
(1-Needle, 2-Thread Overlock)
- UH 9003** (1針3線包縫機)  
(1-Needle, 3-Thread Overlock)

- 一般包縫  
General Plain Seaming
- 一般薄至中厚布料，拷邊或接合用；可用於針織布，梭織布，斜紋布。  
For general plain seaming on light to medium weight materials. Knit wear, woven wear.



#### UH 90B3

- 細邊包縫(手巾包邊)(1針2線, 1針3線)  
Fine Edging (Handkerchief Edging)  
(1-Needle 2-Thread, 1-Needle 3-Thread)
- 手帕、頭飾、絲巾、襪子等。極薄至薄布料。  
Handkerchief, scarf, socks, etc.  
Fine to light materials.

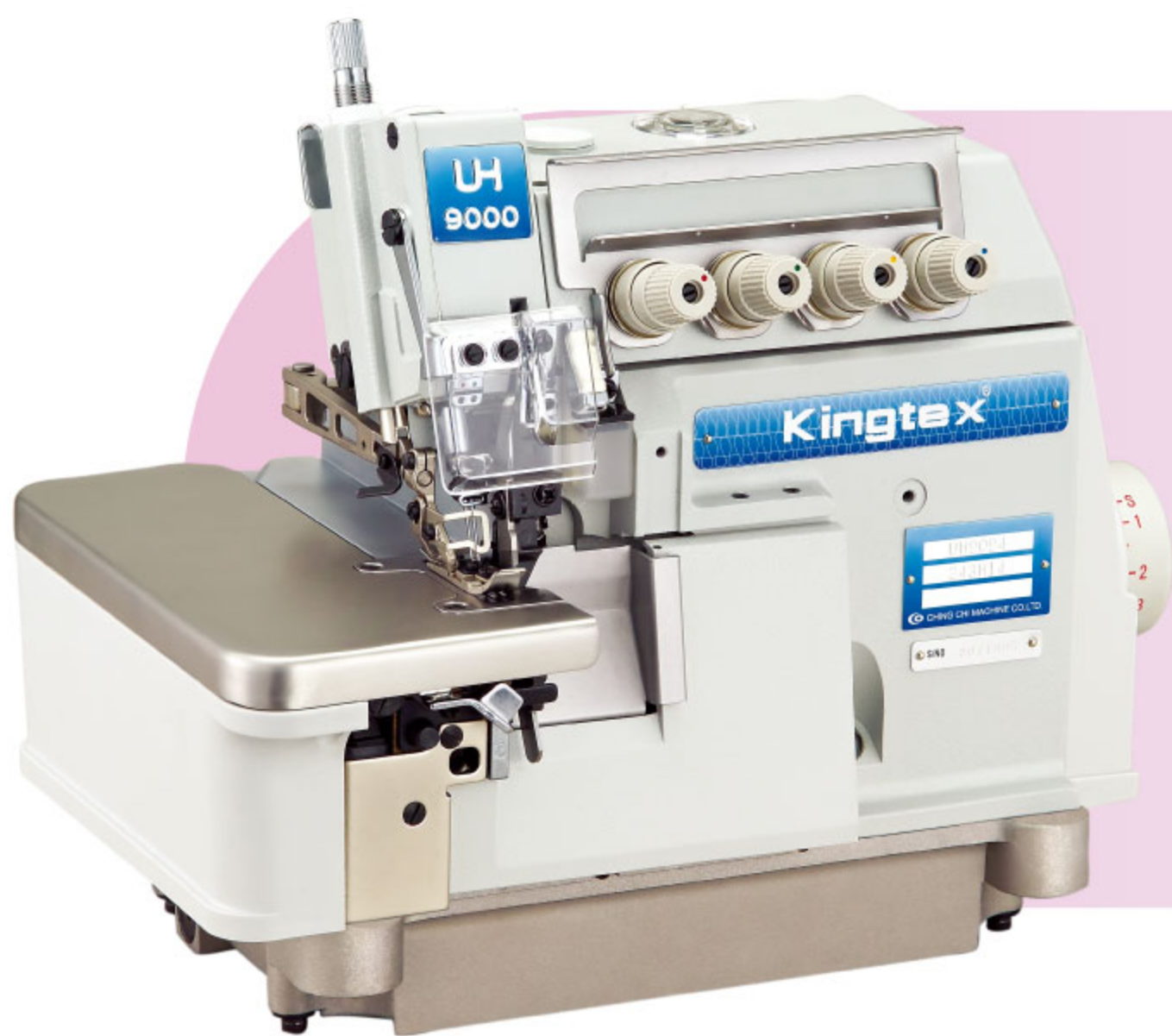
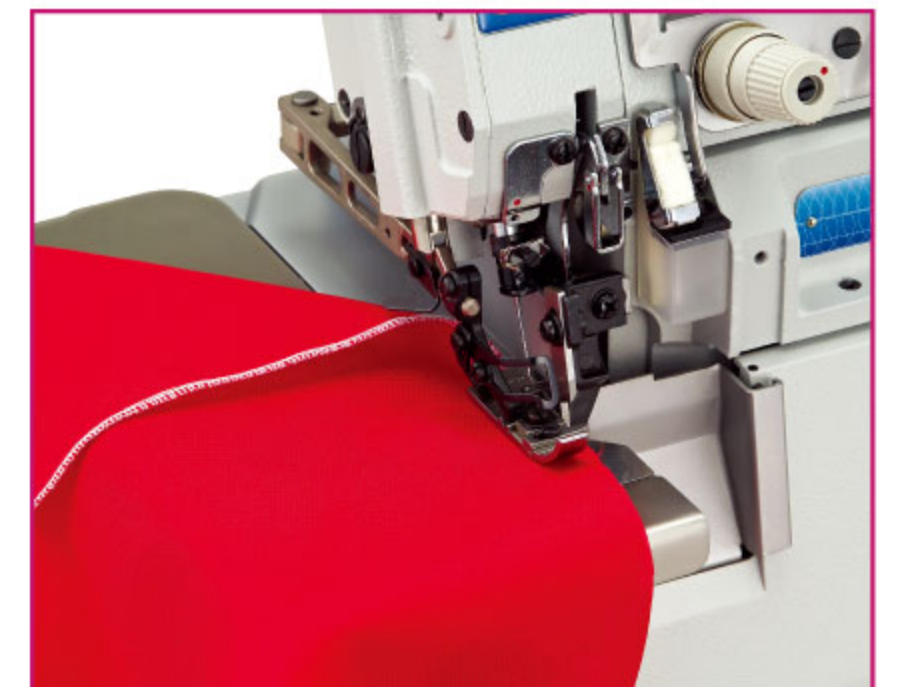

#### UH 9004



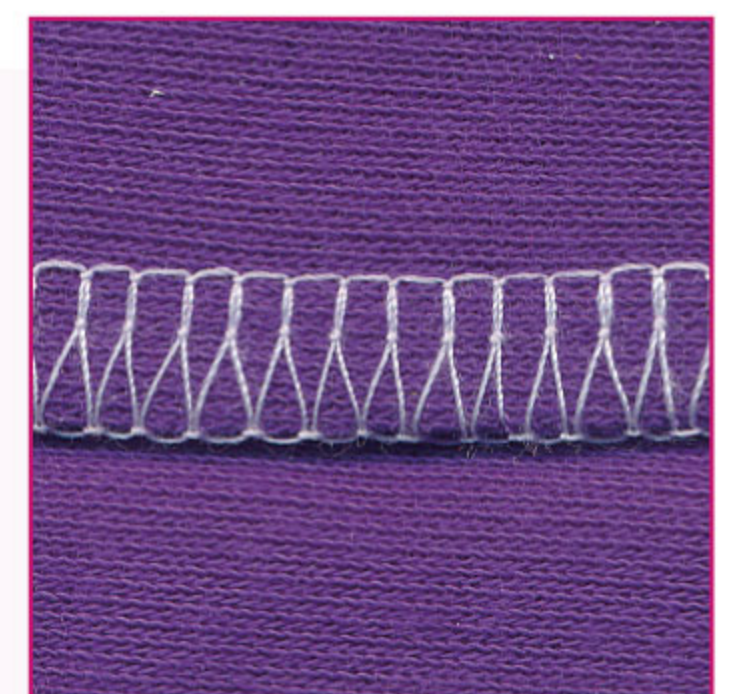





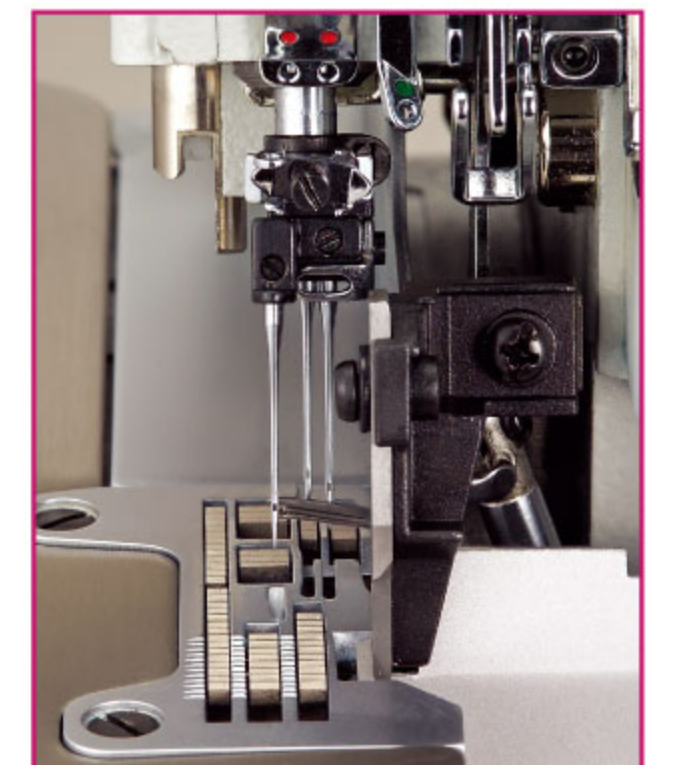

- 一般包縫(2針4線包縫機)  
General Plain Seaming  
(2-Needle, 4-Thread Overlock)
- 一般薄至中厚布料，拷邊或接合用；可用於針織布，泳衣布等。  
For general plain seaming on light to medium weight materials: Knit wear, swimming wear.

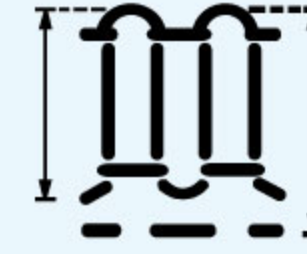

#### UH 9006

- 三針六線萬用型包縫機  
3-Needle, 6-Thread Muti-Use Overlock Machine
- 薄至中厚布料。  
Light to medium weight materials.



			 m.m.	 m.m.	 max.m.m.		 m.m.	 DC x 27	 S.P.M.	OPTIONAL DEVICE
UH9002-032-M03 UH9002-052-M03	1	2	-	3   2 5   3	3.8	0.8~1.8	6	#11	7000	●SS-033 ●FS
UH9003-0□□-M04 UH9003-0□□-H04	1	3	-	3   4 5	3.8	0.7~2	6	#11 #14	7000	●SS-033 ●FS
UH90B3-022-F04 UH90B3-022-L04	1	3	-	3	3.8	0.7~2	5	#9	7000	●SS-033 ●FS
UH9004-2□□-M14	2	4	2.2	3   5 4   6 5   7 6   8	3.8	0.7~2	5.5	#11	7000 6500	●SS-033 ●FS ●TB
UH9004-253-H14 UH9004-353-M12	2	4	2.2 3	5   7 5   8	3.8	0.7~2	5.5	#11 #14	7000 7000	
UH9004-2□□□-M14	2	4	2.2	3   5 4   6	3.8	0.7~2	5.5 6	#11	7000	
UH9006-3243-M44 UH9006-5243-M44	3	6	3 x 2.2 5 x 2.2	4   7 9	3.8	0.7~2	5	#11	6500	●US-040 ●FS





### UH 9005

- 一般包縫 (2針5線安全縫包縫機)  
General Plain Seaming  
(2-Needle, 5-Thread Safety Stitch Overlock)
- 一般薄至稍厚布料，安全縫作業；一般梭織布，襯衫，西褲等。  
For general safety stitch operation on medium to heavy weight materials.  
Woven shirts, trousers etc.

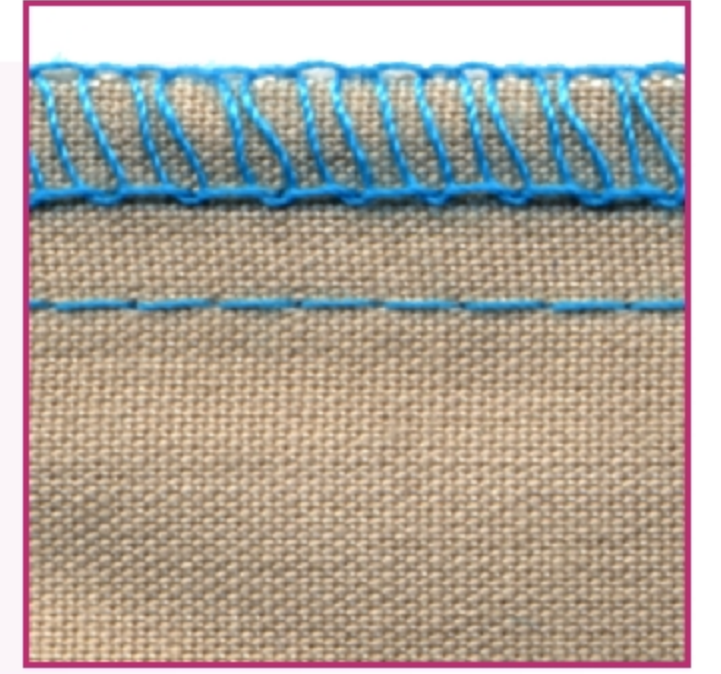

### UH 9105

- 特厚布料車縫 (牛仔布車縫) (2針5線)  
Extra Heavy Weight Material Seaming.  
(2-Needle, 5-Thread)
- 牛仔褲、牛仔布服裝、厚工作服...等厚重布料服裝。  
厚至特厚布料。  
Blue jeans, denim wear---etc.  
Heavy to extra heavy-weight materials.

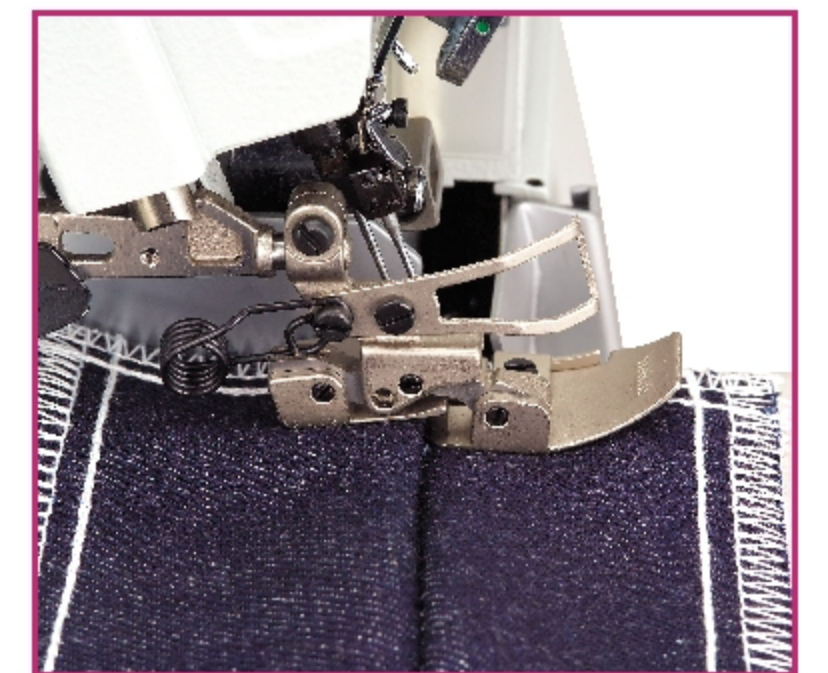

浮動壓腳 Tractor presser foot

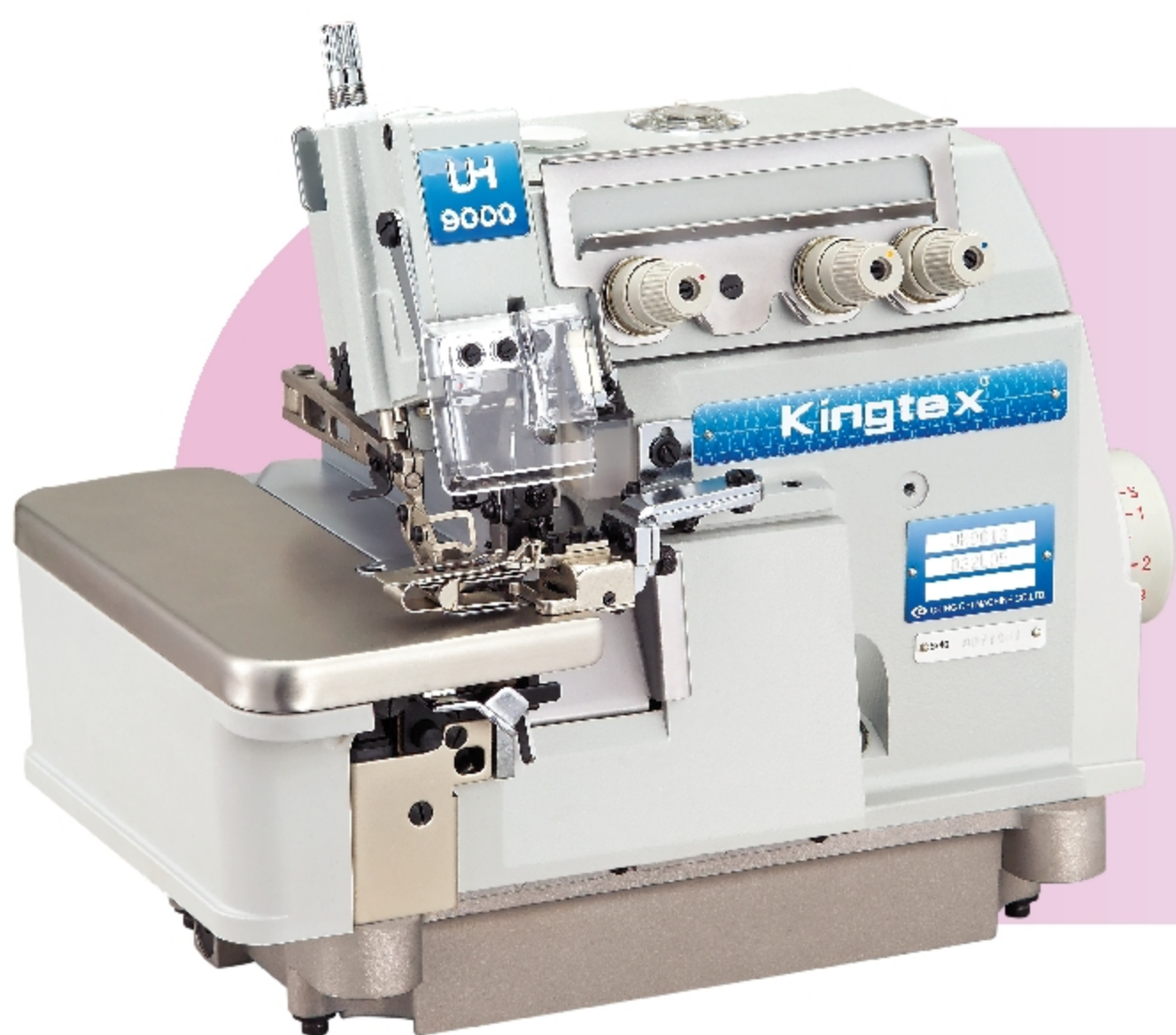

### UH 9013

- 拷下襠 (盲縫) (1針3線)  
Blind Hemming(1-Needle, 3-Thread)
- 針織T恤、內衣、運動衣等。薄至中厚布料。  
T-shirt, underwear, knit-shirt, etc.  
Light to medium weight materials.

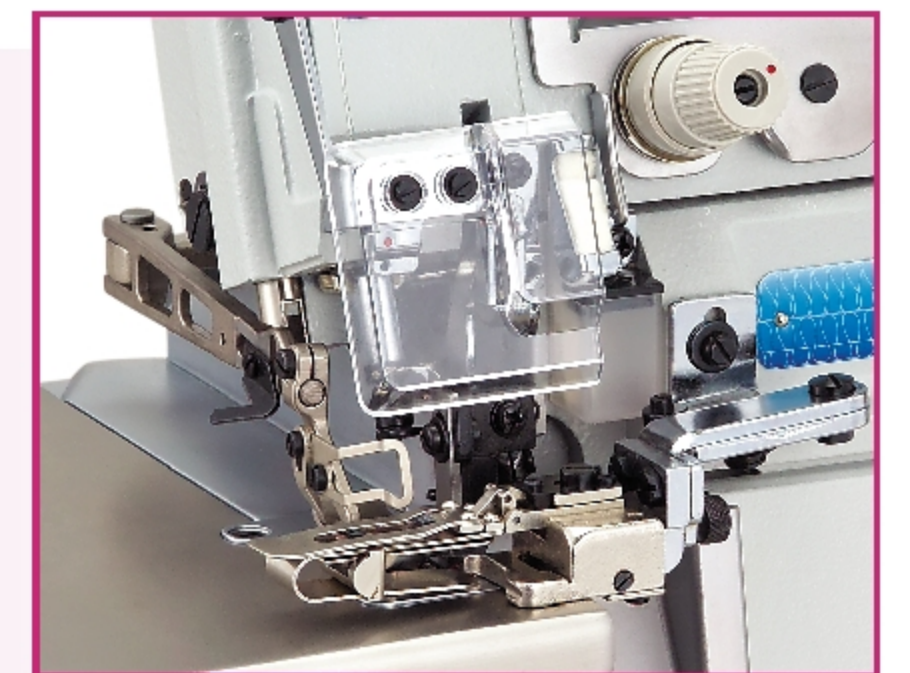

### UH 9024

- 包縫頭車縫 (手動式) (1針3線及2針4線)  
Backlatching(Manual Type)  
(1-Needle, 3-Thread and 2-Needle, 4-Thread)
- 內褲兩側、T恤袖口車縫。薄至中厚布料。  
Suitable for arm-hole, cuff of sweater seaming and closing sides of panties, etc.  
Light to medium weight materials.

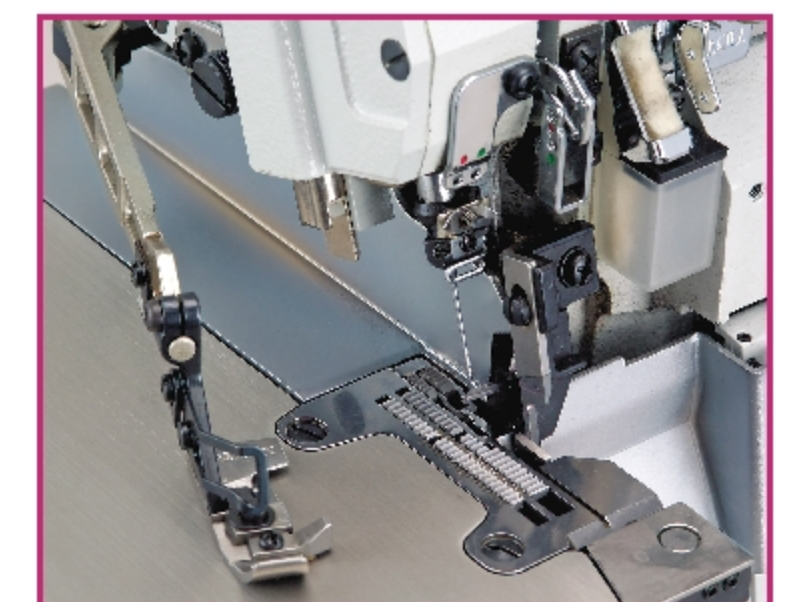

包縫頭車縫 (3線)  
Backlatching device (3-Thread)

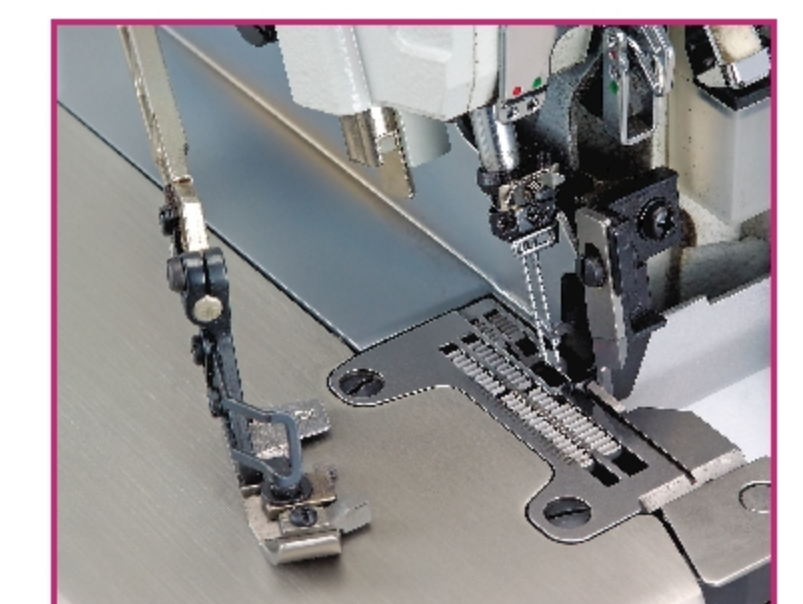

包縫頭車縫 (4線)  
Backlatching device (4-Thread)

											OPTIONAL DEVICE
			m.m.	m.m.	max.m.m.		m.m.	DC X 27	S.P.M.		
UH9005-232-L16			2	3	5						
UH9005-332C-L16			3	3	6						
UH9005-332-M16	2	5	3	3	6	3.8	0.7~2	6	#11	7000	●US-040 ●FS
UH9005-35□-M16			3	5	8						
UH9005-553-M16			5	5	10						
UH9005-553-H16	2	5	5	5	10	4.5	0.6~1.6	6	#16	6000	
UH9105-553-X16	2	5	5	5	10	4.5	0.6~1.6	6	#19	5500	●US-040 ●AG ●FS
UH9013-032-L05	1	3	-	3		3.8	0.7~1.2	5	#9	7000	●SS-033
UH9023-032-M04	1	3	-	3		3.8	0.7~1.2	6			-
UH9024-242-M14	2	4	2.2	4	6	3.8	0.7~1.2	5.5	#11	7000	-



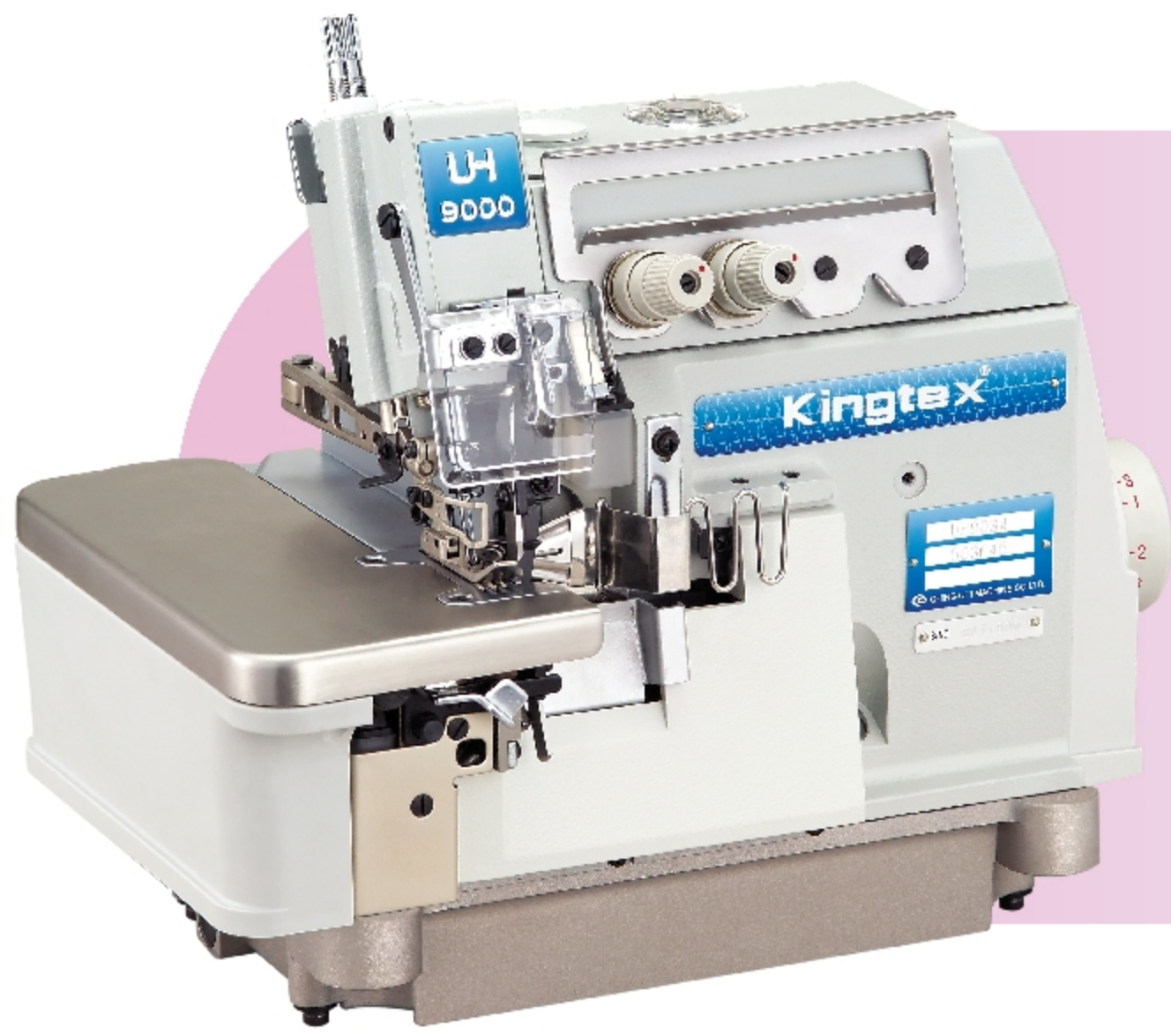

### UH 9034

- 口袋邊包縫(2針4線雙鎖鏈縫)  
Pocket Bags Seaming  
(2-Needle, 4-Thread Double Chain Stitch)
- 大衣, 夾克, 西褲口袋的U型包邊作業。  
Pocket bags of coats, trousers & inter lining of suits.
- 薄至中厚布料。  
Light to medium weight materials.
- 補強帶(包邊帶)適用寬度:入口:1",出口:1/4"  
Applicable width:Opening size:1".  
Finished size:1/4".

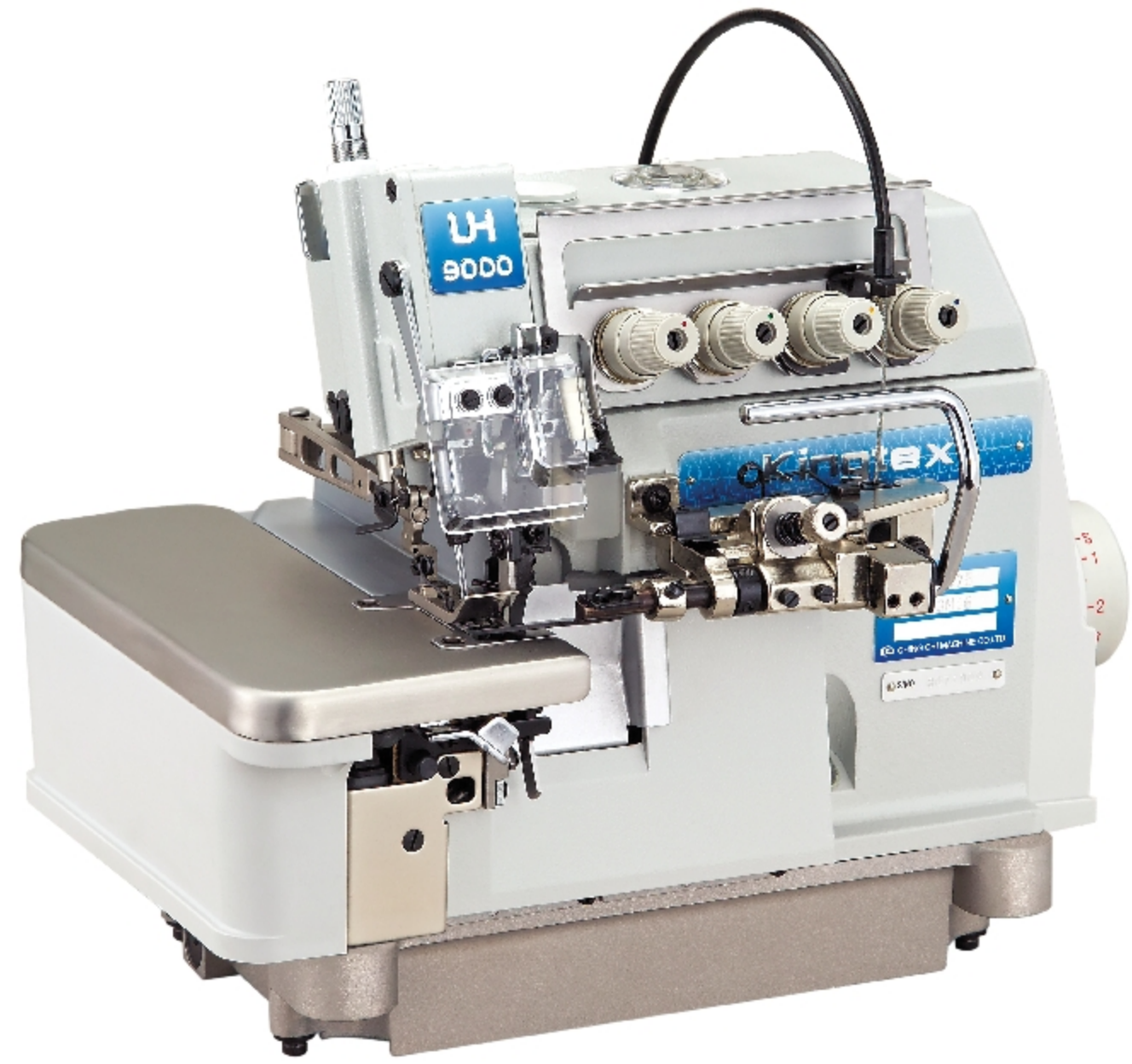
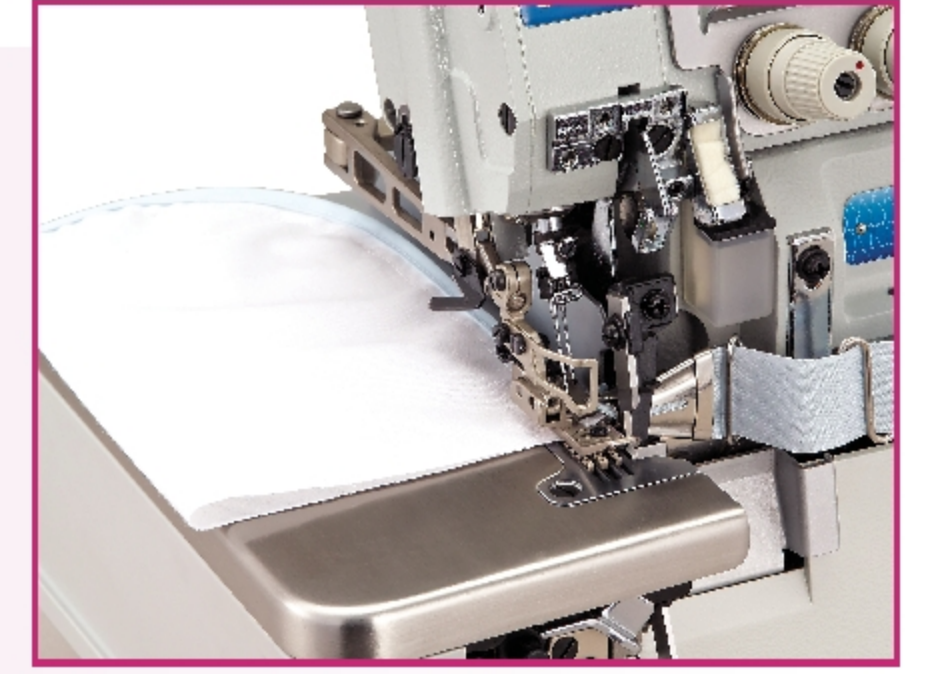

### UH 9045

- 摺景(縮摺)(1針3線,2針4線及2針5線)  
Gathering  
(1-Needle 3-Thread, 2-Needle 4-Thread,  
2-Needle 5-Thread)
- 童裝、女裝、睡衣、床罩、窗簾等。薄至中厚布料。  
Children's wear, ladies wear, pajamas, bed spread,  
curtain etc.  
Light to medium weight materials.

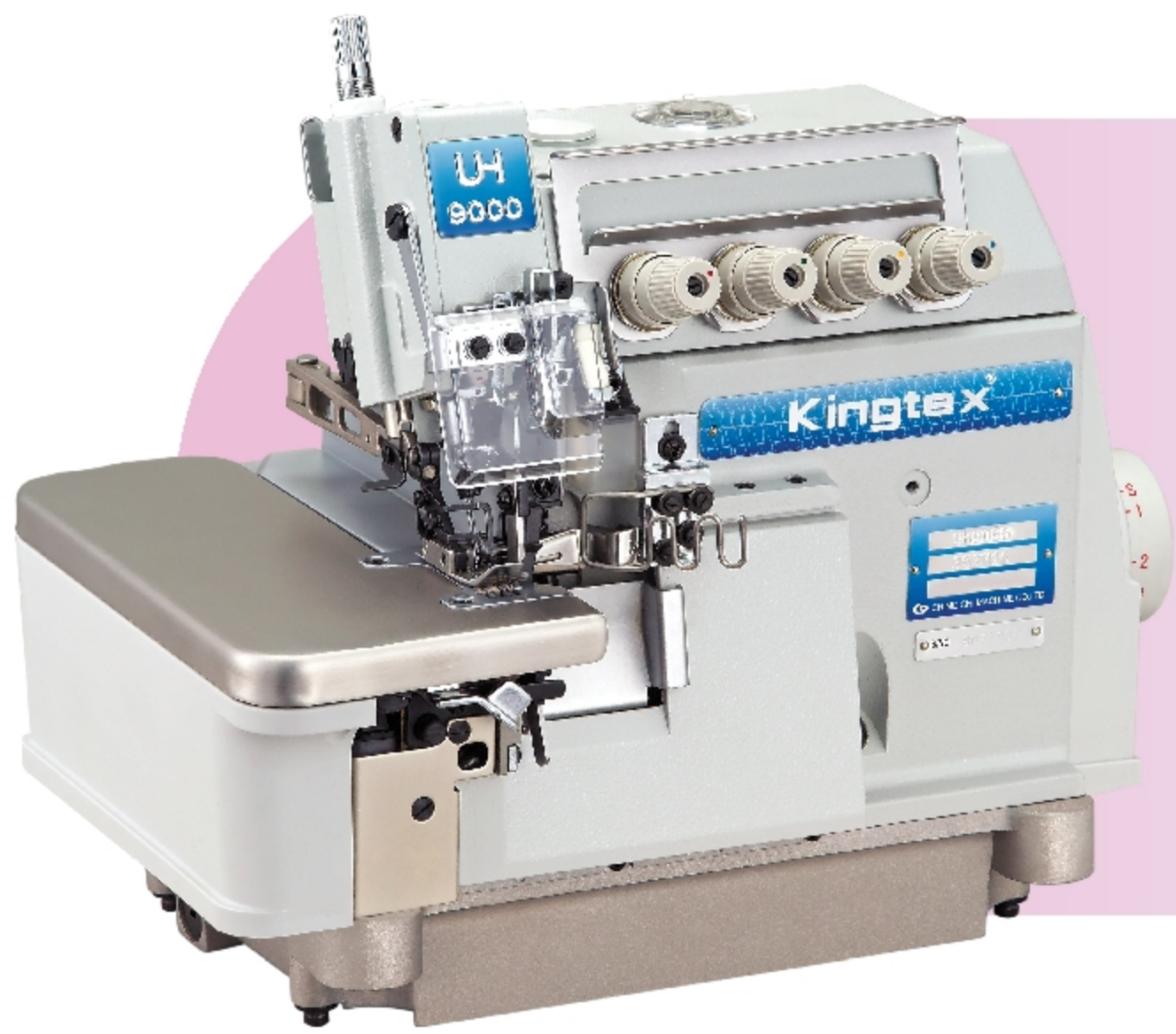

### UH 9055











- 口袋邊包縫(2針5線安全縫)  
Pocket Bags Seaming  
(2-Needle, 5-Thread Safety Stitch)
- 西褲, 大衣, 夾克口袋。  
Pocket bags of coats, suits, trousers, etc.
- 薄至中厚布料。  
Light to medium weight materials.
- 補強帶(包邊帶)適用寬度:入口:9.5m.m(3/8")  
Applicable tape width(standard):opening size:9.5m.m(3/8").

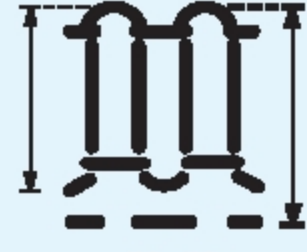

### UH 9065

- 滾邊車縫(2針4線及2針5線)  
Piping Sewing  
(2-Needle, 4-Thread and 2-Needle, 5-Thread)
- 運動裝、女裝、童裝、床罩、桌布---等。薄至中厚布料。  
Sports wears, ladies' wear, children's wear, matterss  
cover table cloths---etc.  
Light to medium weight materials.
- 滾邊布條適用度(標準):7/8"  
Applicable tape width (standard):7/8".
- 包繩直徑:φ 2.0m.m.  
Gimp diameter:2.0m.m.



										OPTIONAL DEVICE
			m.m.	m.m.	max.m.m.		m.m.	DC X 27	S.P.M.	
UH9034-503-M45	2	4	5	-	3.2	0.6~1.6	5	#14	5000	●TC-021
UH9044-243-M14	2	4	2.2	4 6	3	1.0~3.0	5	#11	5500	●SS-033 ●US-040
UH9045-353-M16	2	5	5	5 8	3	0.6~1.6	5	#11	5500	●TC-021
UH9055-353-M16	2	5	3	5 8	3	0.6~1.6	5	#11	5500	●TC-021
UH9064-243-M14	2	4	2.2	4 6	3.8	0.6~1.6	5	#11	5500	●TC-021
UH9065-353-M16	2	5	3	5 8	3.8	0.6~1.6	5	#11	5500	



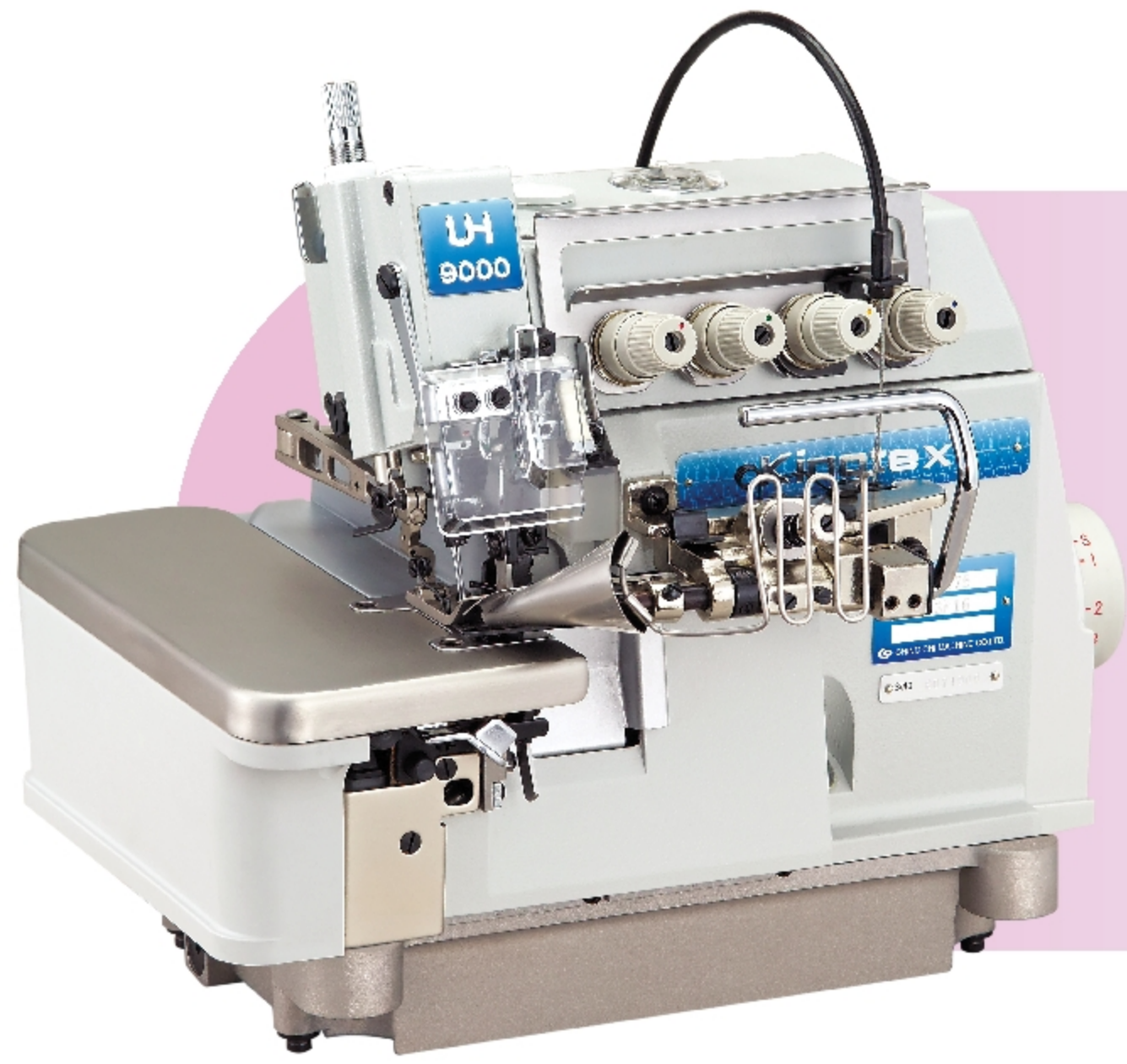

### UH 9075

- 滾邊及縮摺 (2針4線及2針5線)  
Gathering & Piping  
(2-Needle, 4-Thread & 2-Needle, 5-Thread)
- 睡衣、童裝、女裝 (UH-9075, 小管型)。  
Ladies' knit shirts, negligees, children's wear, pajamas, etc. (UH-9075).
- 床上用品、床單、沙發椅套、汽車椅套等 (UH-9075/A, 大管型)。  
中至中厚布料。  
Bed covering, Bed spreading, sofa covering, etc. (UH-9075/A).  
Medium to medium weight materials.
- 補滾邊帶適用寬度: 1-1/2" (UH-9075/A); 7/8" (UH-9074, UH-9075).  
Applicable tape width: 1-1/2" (UH-9075/A); 7/8" (UH-9074, UH-9075).

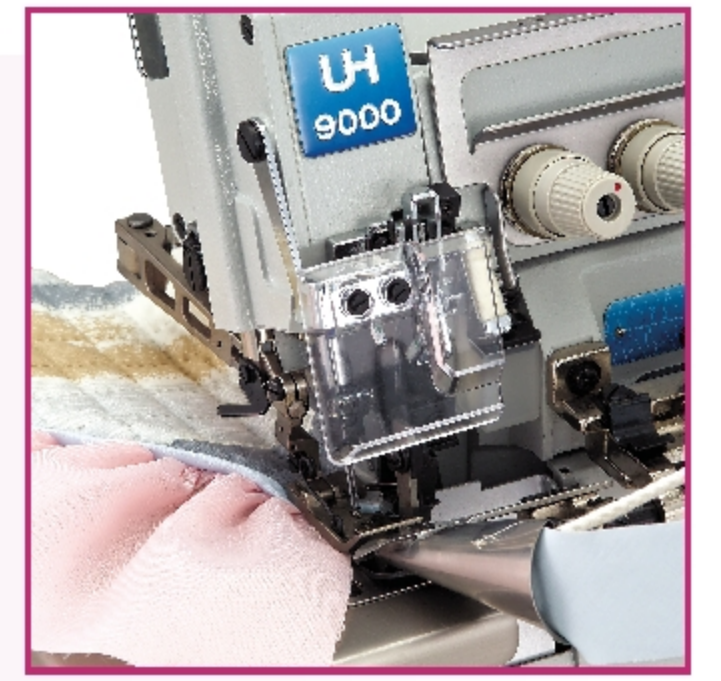

												OPTIONAL DEVICE
UH9074-243-M14	2	4	2.2	4	6	3	1.0~3.0	5	#11	5500	2.0 m.m.	●TC-021
UH9075-353-M16	2	5	3	5	8	3	1.0~3.0	5	#11	5000		
UH9075/A-353M16	2	5	3	5	8	3	1.0~3.0	5	#11	5000	5.0 m.m.	●AG

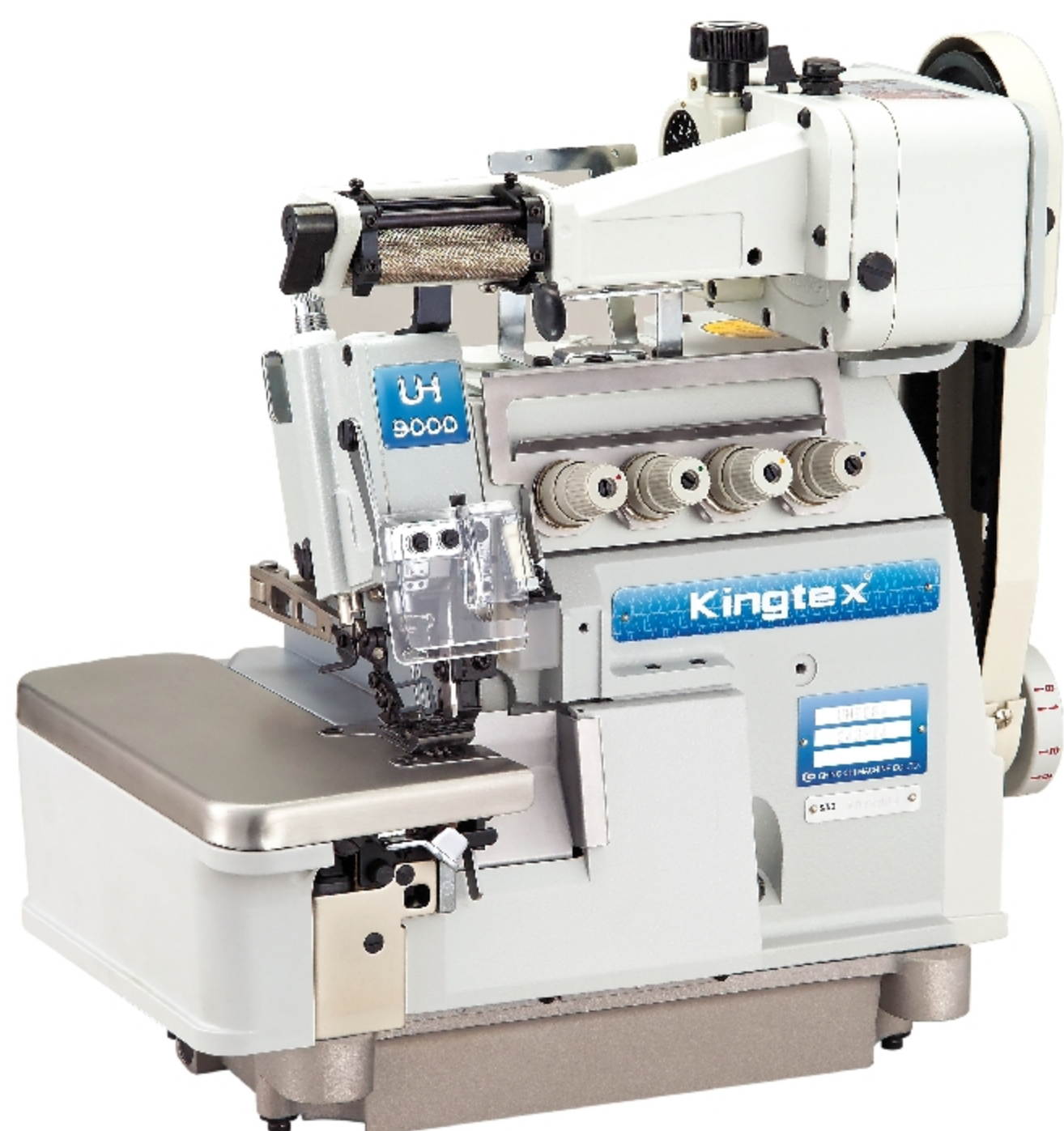

### UH 9083

- 鬆緊帶包縫 (1針3線及2針4線)  
Elastic Tape Attaching  
(1-Needle 3-Thread & 2-Needle 4-Thread)
- 泳衣、內衣、短褲。鬆緊帶適用寬度: 9m.m.~17m.m.  
Swimming wear, underwear men's briefs, etc.  
Elastic tape applicable width: 9m.m.~17m.m.

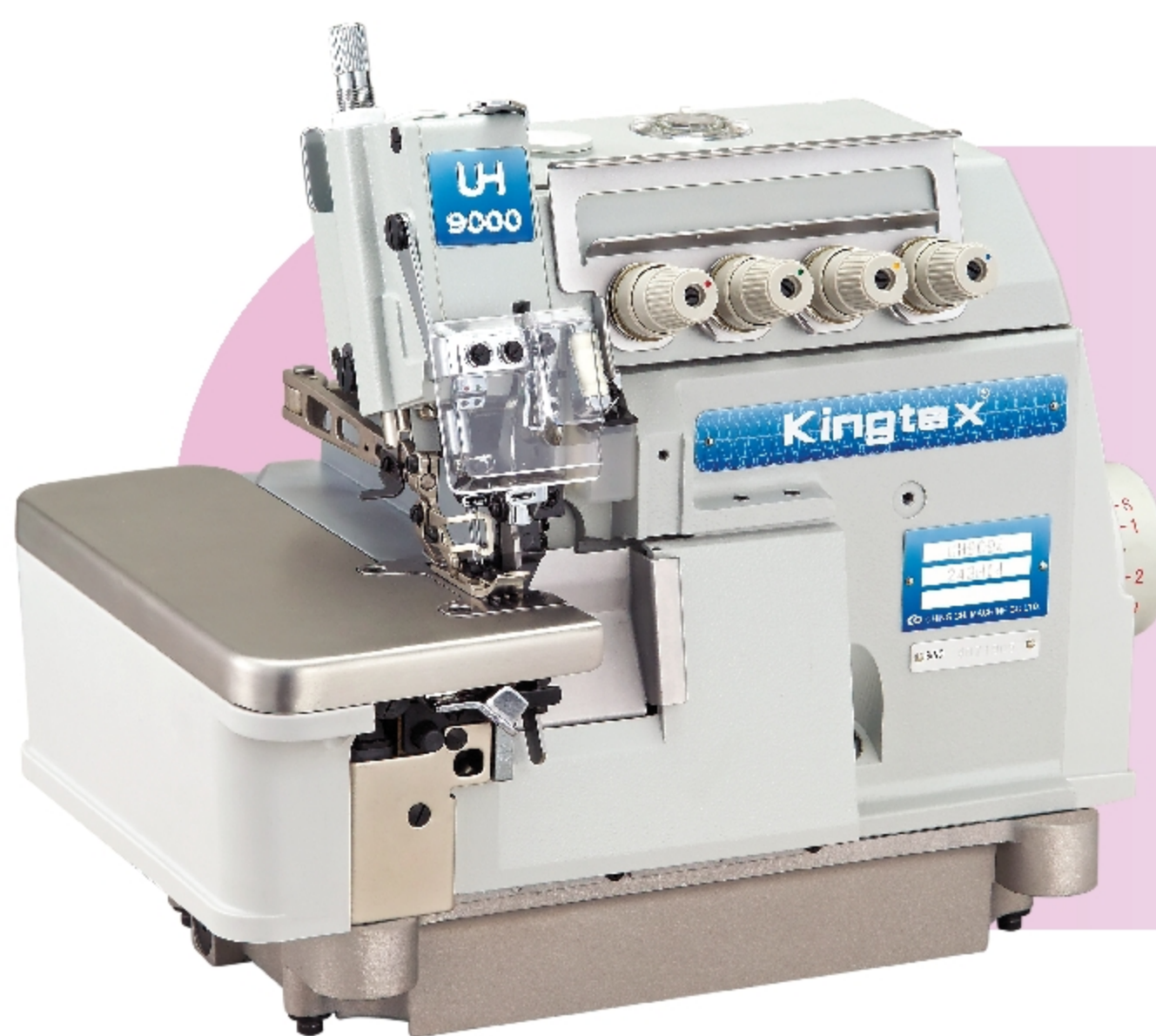
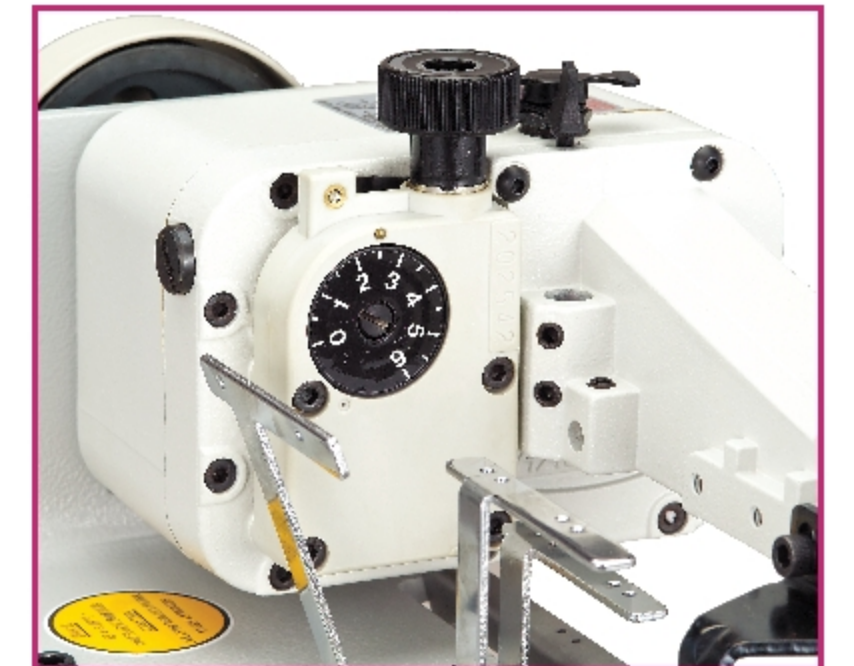

### UH 9094

- 厚毛衣料包縫 (2針4線)  
Sewer Seaming  
(2-Needle, 4-Thread)
- 厚料毛衣或厚料針織物。中厚至厚布料。  
Bulky sweater and heavy-weight knit wear.  
Medium to heavy weight material.
- 補強帶(肩帶)最大適用寬度: 1/5"(5.0m.m.)  
Max. applicable tape width: 1/5"(5.0m.m.)



											OPTIONAL DEVICE
UH9083-053-H04	1	3	-	5	3.2	0.7~2	6	#14	7000	●TC-021	
UH9084-243-H14	2	4	2.2	4	6	3.8	0.8~2.4	6	#14	7000	●TFC
UH9094-243-H14	2	4	2.2	4	6	3.2	0.8~2.4	6	#14	7000	●SS-033 ●TC-021 ●AG ●FS





#### UH9300 series

- 一般包縫  
Plain seaming
- UH9300系列筒型鎖邊機，它擁有小的筒型機座，適用於小型圓筒物縫製，細筒的圓周(長度)只有147mm。關於T恤衫的袖口折縫，兒童服裝的袖口.....等，都能簡單處理好，亦在筒座周圍無障礙物，在落針處的右側設有10mm的空間，可以裝配各種裝置。  
The UH9300 series overlock machines is equipped with the small cylinder bed, can be used on smaller garment, the radius of the cylinder bed is only 147 m.m.  
The sleeve hemming for the T-shirt, the sleeve of children clothing etc., all can be handled easily. And there are no obstacles around the cylinder bed, so there is a 10 m.m. space on the right hand side of the needle drop point for optional devices to be equipped.



											OPTIONAL DEVICE
UH9302-032-M03	1	2	-	3	2	3.8	0.8~1.8	6	#11	7000	
UH9302-053-M03	1	2	-	5	3	3.8	0.8~1.8	6	#11	7000	
UH9303-032-M04	1	3	-	3	2	3.8	0.8~1.8	6	#11	7000	
UH9303-053-M04	1	3	-	5	3	3.8	0.8~1.8	6	#11	7000	●SS-034
UH9304-243-M14	2	4	2.2	4	6	3.8	0.8~1.8	5.5	#11	7000	
UH9304-253-M14	2	4	2.2	5	7	3.8	0.8~1.8	5.5	#11	7000	
UH9313-032-L05	1	3	-	3	2	3.8	0.8~1.8	5	#9	7000	

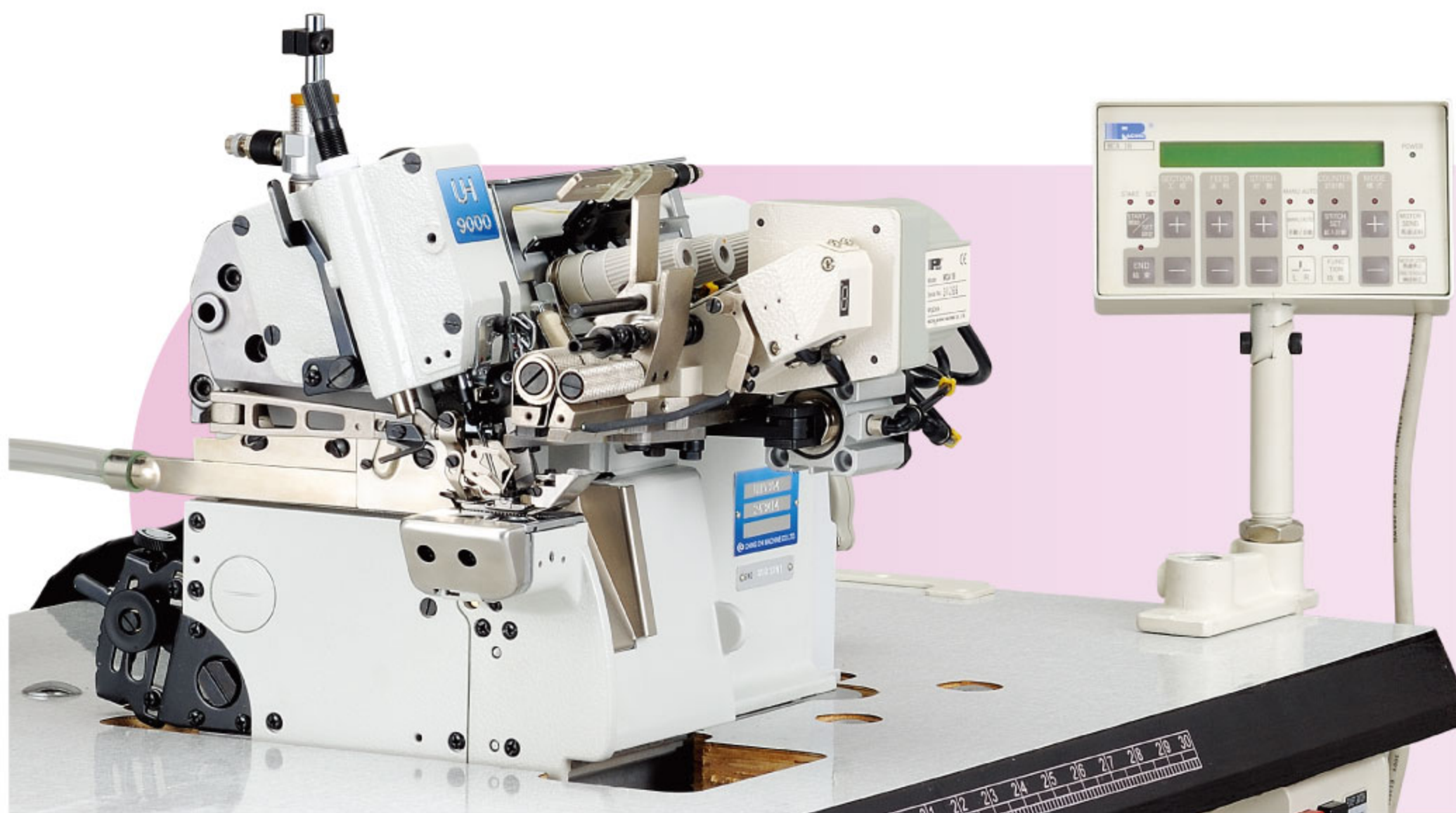

#### UHD 93A3-053-M04/MCA-20K/TR/TFU16-3/UT2

- 鬆緊帶包縫  
Elastic Tape Attaching
- 自動切帶及送帶的功能，有26組程式及記憶  
Auto-cutting and re-inserting. It can meet different sewing requirements by powerful multi-function operation panel with 26 program memory.
- 附有切帶裝置  
可縫製各種鬆緊帶製品，特別是縫製圓筒型製品的接頭，車縫中鬆緊帶可以在壓布腳前自動快速切斷再重疊車縫，接頭平整美觀，車縫前後，壓布腳自動提升鬆緊帶，自動送到壓腳下待用。  
With Cutting Device  
For any elastic attaching sewing, special for connecting the circle sewing. During the sewing operation, it can auto cut the tape fast in front of the presser foot for covering sewing to make the flat and beautiful sewing. In the beginning and after finished sewing, the presser foot will be lifted automatically. And the elastic tape will be re-inserted into the presser foot for next sewing operation.

**TR** 鬆線裝置: MCA 20K專用(選擇配件)  
Thread Release Device : For MCA 20K Only (Optional Parts)  
MCA 20K-38/TR  
MCA 20K-64/TR

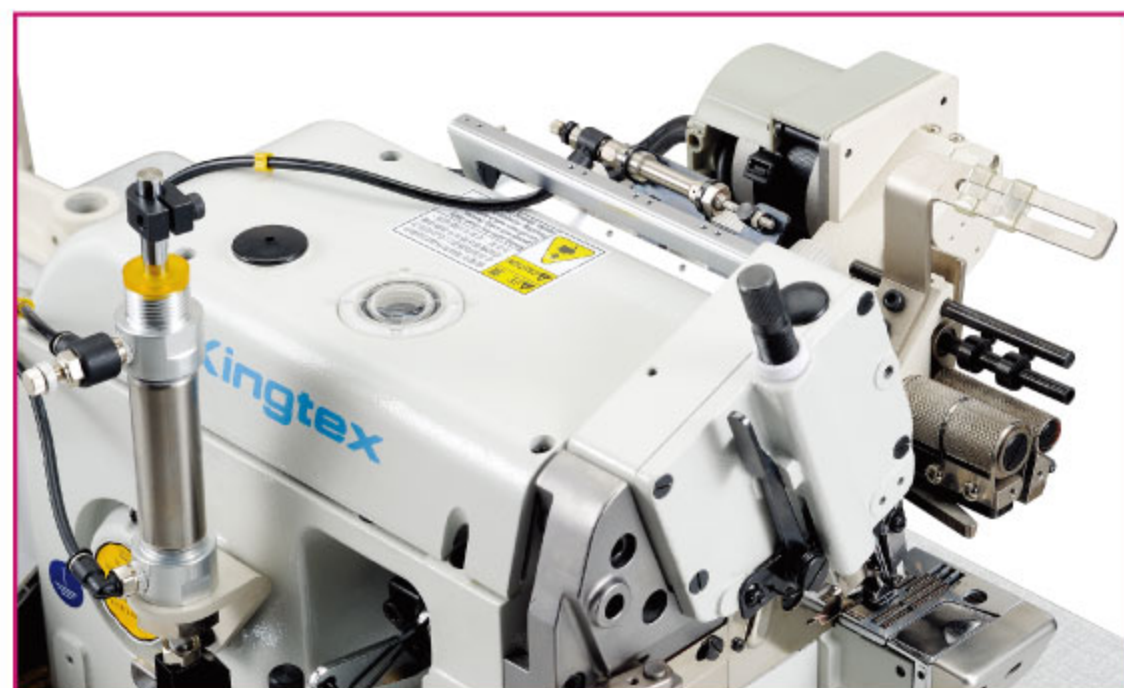

縫畢時可將車針的縫線放鬆便於切斷  
Release the thread for cutting thread easily after sewing.

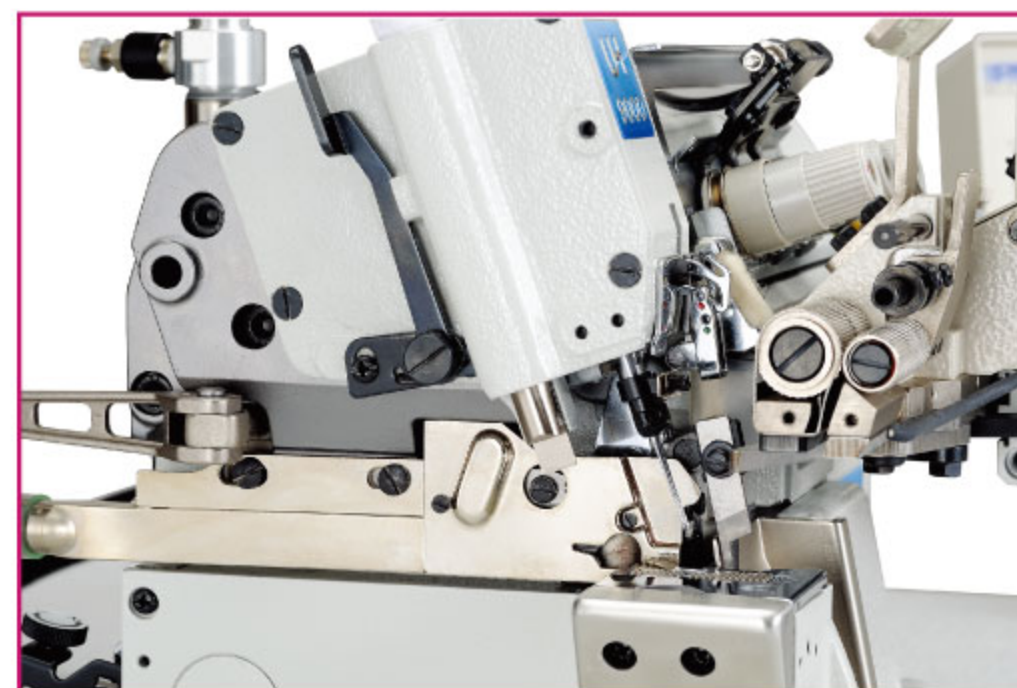

適用於有安裝吸入式線頭切斷裝置的包縫車  
Suitable for overlock with chain cutter and lint collector.

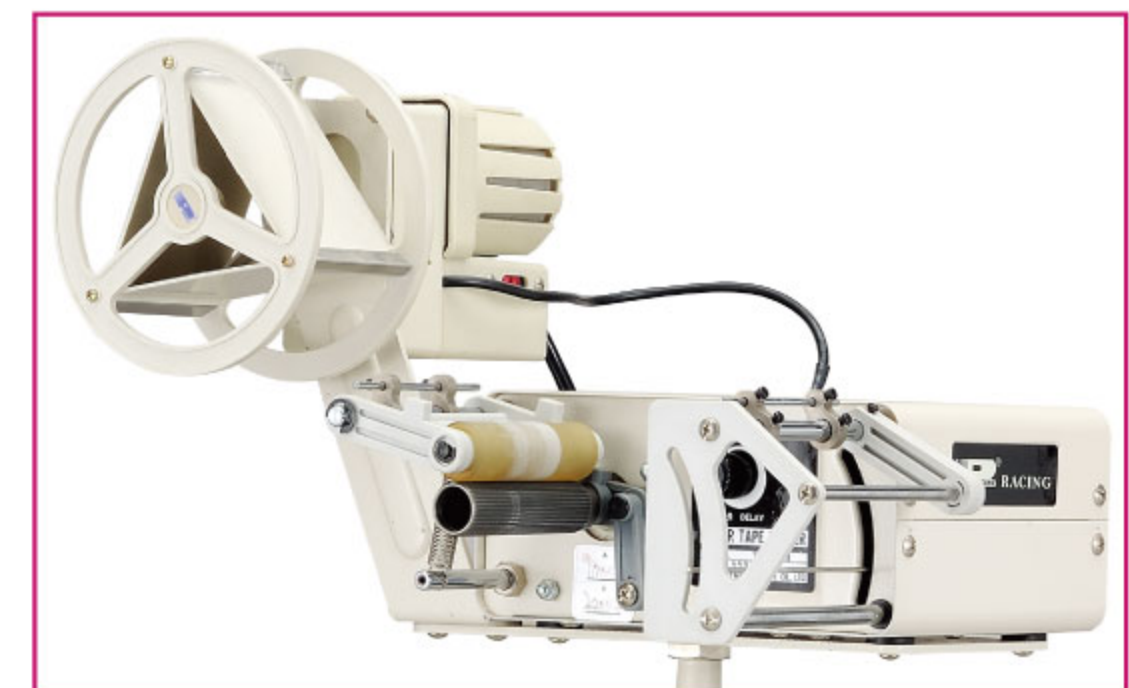

**TFU 16-3 / UT-2**  
上送型送料機(附電動型防止打結裝置)，送料寬度70mm  
Upper tape feeder (with untangling motor device).  
Feed width 70mm  
**TFU 16-8** 上送型送料機，送料寬度 200mm  
Upper tape feeder, Feed width 200mm











											OPTIONAL DEVICE
UHD93A3-053-M04	1	3	-	5	3	3.8	0.8~1.8	6	#11	7000	●SS-034
UHD93A4-243-M14	2	4	2.2	4	6	3.8	0.8~1.8	5.5	#11	7000	





### UHD9000F series

- 直驅式伺服馬達平床包縫機  
Direct drive type mini servo motor flat bed overlock machine

			 m.m.	 m.m.		 max.m.m.		 m.m.	 DC X 27	 S.P.M.	OPTIONAL DEVICE	
UHD9002F-032-M03	1	2	-	3	2	3.8	0.8~1.8	6	#11	7000	● SS-033	
UHD9002F-053-M03				5	3							
UHD90B3F-022-F04	1	3	-	2	1	3.8	0.7~2	5	#9	7000		
UHD90B3F-022-L04				2							● SS-033	
UHD9003F-032-M04				3	2				#11		● FS	
UHD9003F-053-M04	1	3	-	5	3	3.8	0.7~2	6	#11	7000		
* UHD9003F-053-H04				5	3				#14			
UHD9004F-232-M14				3	5	2			#11	7000		
UHD9004F-232F-M14				3	5	2			#11	7000		
UHD9004F-233-M14				3	5	3			#11	7000		
UHD9004F-242-M14				4	6	2			#11	7000		
UHD9004F-243-M14	2	4	2.2	4	6	3	3.8	0.7~2	5.5	7000	● SS-033	
UHD9004F-253-M14				5	7	3			#11	7000	● FS	
▲ UHD9004F-253-H14				5	7	3			#14	7000		
UHD9004F-263-M14				6	8	3			#11	6500		
UHD9004F-353-M12	2	4	3	5	8	3	3.8	0.7~2	5.5	#11	7000	
UHD9004F-243E-M14	2	4	2.2	4	6	3	3.8	0.7~2	6	#11	7000	● TB006
UHD9005F-232-L16			2	3	5	2						
UHD9005F-332C-L16			3	3	6	2						
UHD9005F-332-M16			3	3	6	2						
UHD9005F-352-M16	2	5	3	5	8	2	3.8	0.7~2	6	#11	7000	
UHD9005F-353-M16			3	5	8	3					● US-040	
UHD9005F-553-M16			5	5	10	3					● FS	
* UHD9005F-553-H16	2	5	5	5	10	3	4.5	0.6~1.6	6	#16	6000	
* UHD9006F-3243-M44			3 x 2.2	4	7	3	3.8	0.7~2	5	#11	6500	
UHD9006F-5243-M44	3	6	5 x 2.2	4	9							
UHD9013F-032-L05	1	3	-	3	2	3.8	0.7~2	5	#9	7000	● SS-033	
UHD9023F-032-M04	1	3	-	3	2	3.8	0.7~2	6	#11	7000	● BT086	
UHD9024F-242-M14	2	4	2.2	4	6	2	3.8	0.7~2	5.5	#11	7000	● BT084
UHD9034F-503-M45	2	4	5	-	3	3.2	0.6~1.6	5	#14	5000	● TC-021	
UHD9044F-243-M14	2	4	2.2	4	6	3	3	1.0~3.0	5	#11	5500	● SS-033
UHD9045F-353-M16	2	5	3	5	8	3	3	1.0~3.0	5	#11	5500	● US-040
UHD9055F-353-M16	2	5	3	5	8	3	3	0.6~1.6	5	#11	5500	
UHD9064F-243-M14	2	4	2.2	4	6	3	3.8	0.6~1.6	5	#11	5500	● TC-021
UHD9065F-353-M16	2	5	3	5	8	3	3.8	0.6~1.6	5	#11	5500	
UHD9074F-243-M14	2	4	2.2	4	6	3	3	1.0~3.0	5	#11	5500	
UHD9075F-353-M16	2	5	3	5	8	3	3	1.0~3.0	5	#11	5000	● GC061 ● GC061A
* UHD9083F-053-H04	1	3	-	5	3	3.8	0.7~2	6	#14	7000	● TC-021	
* UHD9084F-243-H14	2	4	2.2	4	6	3	3.2	0.8~2.4	6	#14	7000	● TFC
* UHD9094F-243-H14	2	4	2.2	4	6	3	3.2	0.8~2.4	6	#14	7000	● TB05 ● 寬刀, 帶架
* UHD9105F-553-X16	2	5	5	5	10	3	4.5	0.6~1.6	8	#19	5500	● US-040 ● AG ● FS

\* 粗齒, 針板大孔  
Thicker teeth bigger needle plate hole

▲ 針板大孔  
Bigger needle plate hole

註: UH9000 規格, UH9000F 規格, UHD9000F 規格與 UHD9000 規格一致



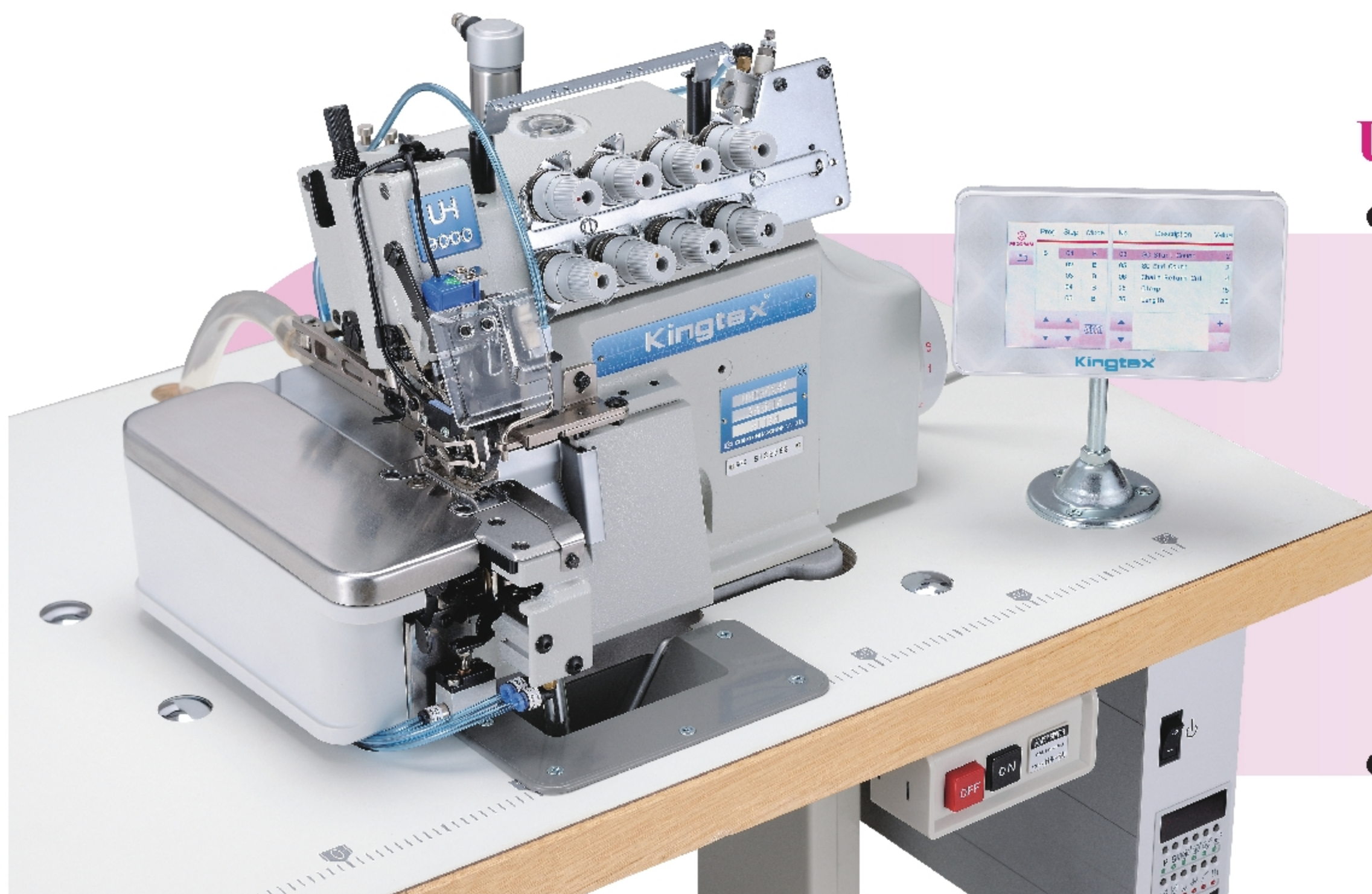

#### UHD 9024A

- 直驅式伺服馬達平床自動包線頭包縫機。  
Flat bed overlock machine with patented built-in type direct drive mini servo motor for automatic backlatching application.
- 壓腳提昇時，送布齒即從針板上落下，使得布料的設置作業更為便利。  
When presser foot lifting, feed dogs will be sunken from the surface of needle plate and pre-sewing preparation of fabrics can be obtained easily.
- 採用馬達直接驅動大心方式，省卻皮帶之傳動，起動速度快，耗損少，最高速可達 7000 rpm。  
Mini servo motor link together with crank shat directly, no need to use traditional motor belt, fast starting, no worn out problem running speed can up to 7000 rpm.
- 配合全彩觸控面板，大圖示指示說明，提升使用便利性。  
Using full color touch-type screen panel with bigger illustration, very convenience and easy to use.
- 在縫製 T 恤袖口工程時，可自動將線頭包在線跡中，用於中厚類布料。  
When sewing the sleeves of T-shirts or polo shirts, the thread ends can be saw within the overedge. suitable for medium to heavy materials.

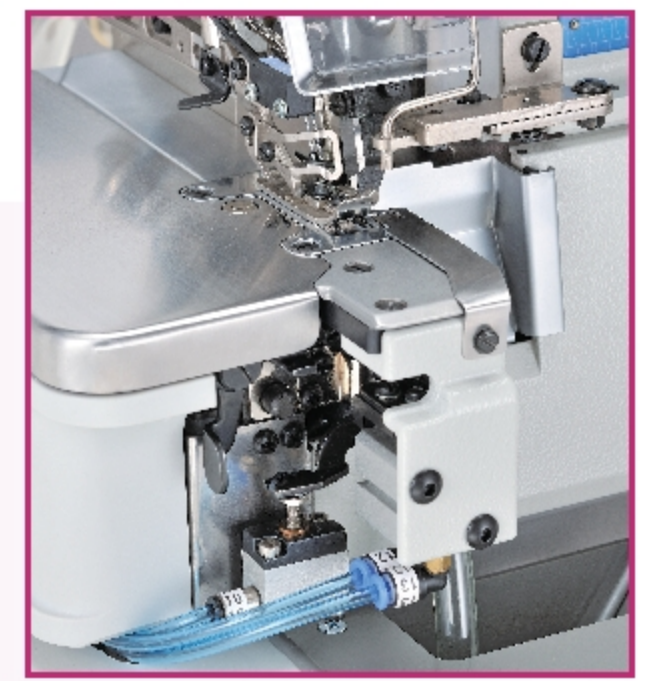

- P: 基本縫  
Plain seaming
- B: 倒回縫  
Backlatching
- L: 開始鬆線倒回縫  
Backlatching with thread chain loosened at the start of sewing
- S: 倒回縫後鬆線縫  
Special backlatching

可依照縫製工序中，需要布料起縫處發生收縮或鎖縫時，把橡筋部的設定到線鏈壓線處的方式。  
When sewing the pre-attached elastic tape onto the brief or similar garments that the stitch counter can set the stitch numbers of thread chains needed in the front of elastic tape when the sewing operation is ready for attaching the elastic tape onto the garments.



提供十種縫機自我檢測方式，輕鬆調整最佳狀態。  
Able to provide 10 self-testing methods, the best sewing situation can be obtained easily.



#### UHD 9034C

- 直驅式伺服馬達平床口袋邊包縫機  
Flat bed overlock machine with patented built-in type direct drive mini servo motor for pocket bags seaming.
- 大衣、夾克、西褲口袋的U型包邊作業。  
For sewing pocket bags of coats, trousers & interlining of suits.
- 補強帶(包邊帶)適用寬度：入口：1"，出口：1/4"。  
Applicable width: Opening size: 1" .  
Finished size: 1/4"
- 新設計，插入型雙結線鉤，配合六角螺絲旋緊，穩固及方便裝卸。  
New and improved design, inserting double chain loopers secure tightening by hexagon screw, for easy assembling.

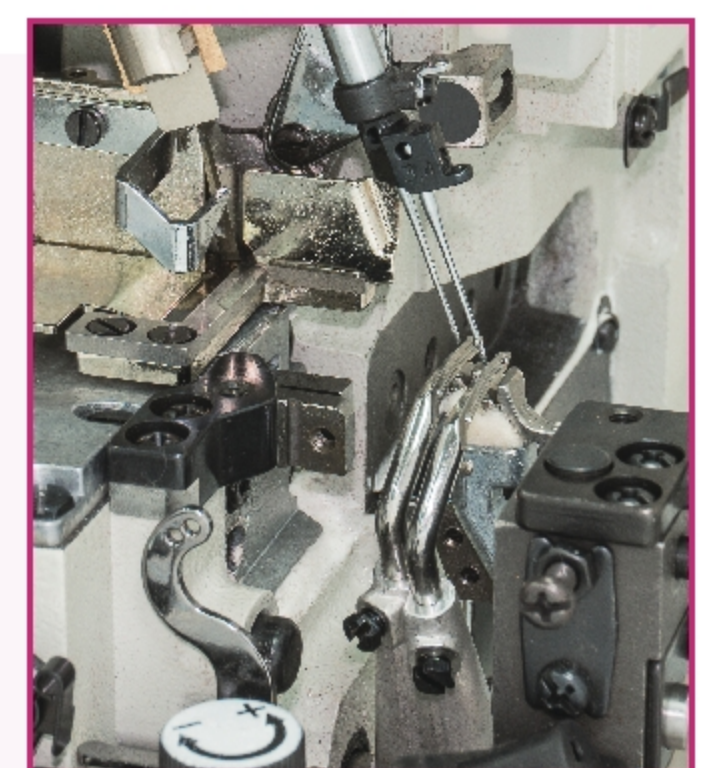

												OPTIONAL DEVICE
			m.m.	m.m.		max.m.m.		m.m.		DC X <sup>27</sup>	S.P.M.	
UHD9024A-243-M14	2	4	2.2	4   6	3	3.8	0.7~2	5.5	#11	7000	●BL-124	
UHD9034C-503-M45	2	4	5	-	3	3.2	0.6~1.6	5	#14	5000	●TC-021	





### UHF9000 series

- 平型上送鎖邊機  
Flat bed top feed overlock
- 須對花、對格之或滑溜之布料的車縫作業  
Suitable for fabrics with slippage materials, pattern matching operation.
- 薄至中厚布料。  
Light to medium weight materials.

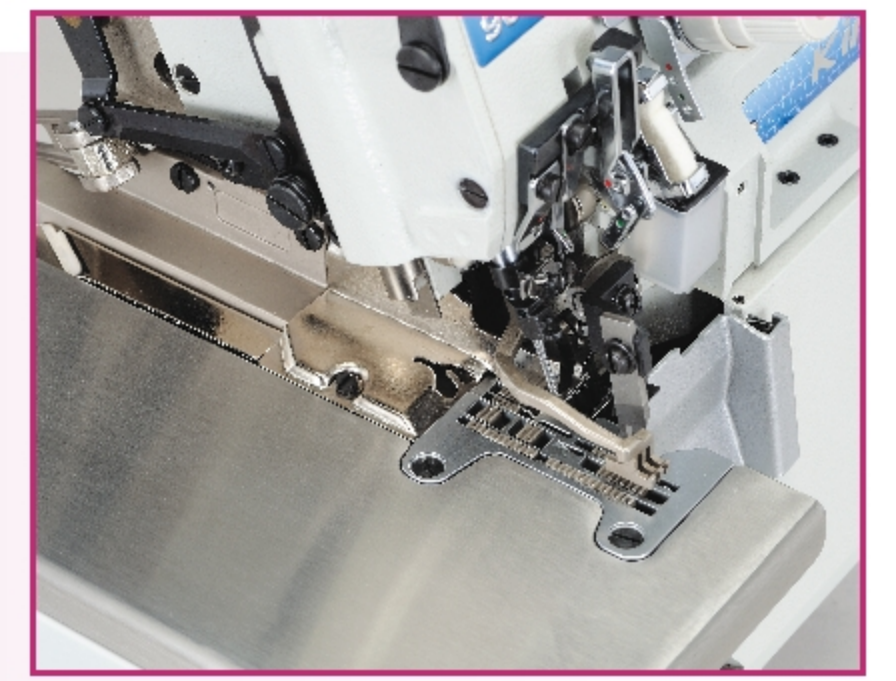

US040:側吸風式自動切線刀(水平吸風式)  
Side suction type thread trimmer (horizontal type).

UHF9000

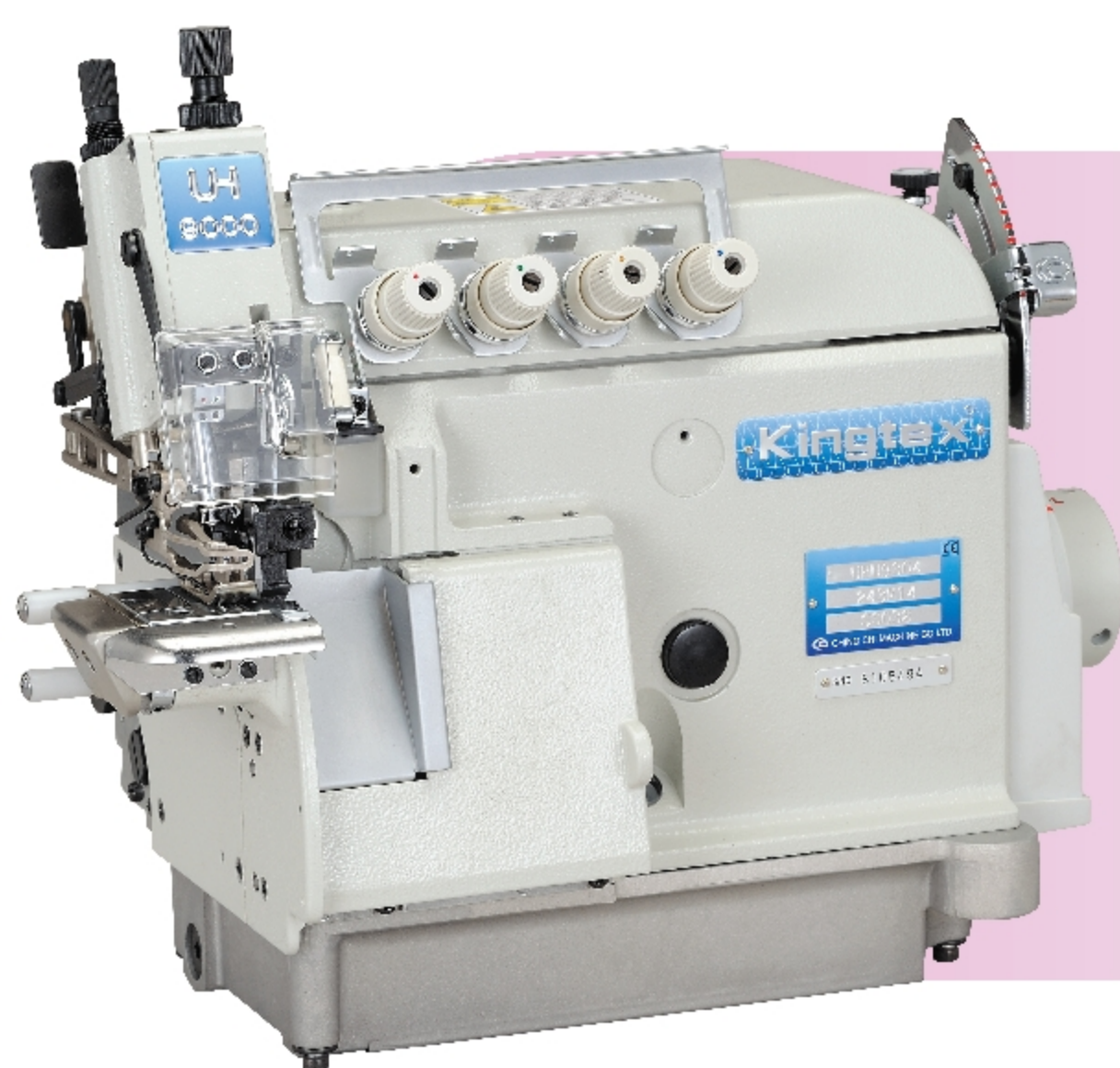





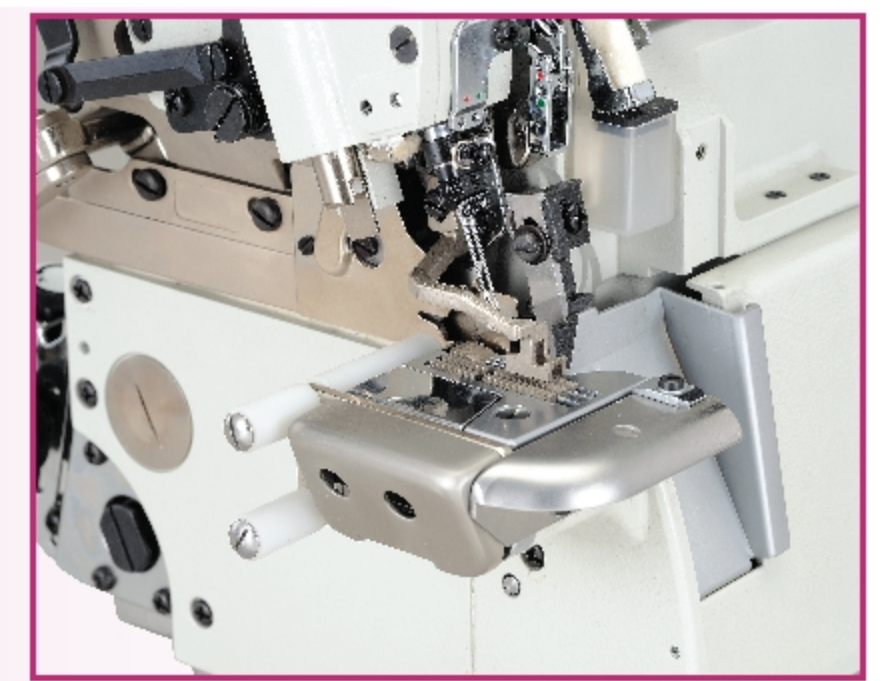





### UHF9300 series

- 筒型上送鎖邊機  
Cylinder bed top feed overlock
- 須對花、對格之或滑溜之布料的車縫作業  
Suitable for fabrics with slippage materials, pattern matching operation.
- 薄至中厚布料。  
Light to medium weight materials.



SS038:側吸風式自動切線刀(垂直吸風式)  
Side suction type thread trimmer (vertical type).

			 m.m.	 m.m.	 max.m.m.			 m.m.	 DC x 27	 S.P.M.	OPTIONAL DEVICE	
UHF9004-243-M14				4	6							
UHF9004-253-M14	2	4	2.2	5	7	3.8	0.7~2	0.8~2	5.5	#11	6500	●SS037
UHF9004-253-H14				5	7							
UHF9004-263-M14				6	8							
UHF9005-353-M16			3	5	8	3.8	0.7~2					
UHF9005-553-M16	2	5	5	5	10	3.8	0.7~2	0.8~2	6	#11	6000	●US040
UHF9005-553-H16			5	5	10	4.5	0.6~1.6					
UHF9105-553-X16	2	5	5	5	10	4.5	0.6~1.6	0.8~2	8	#19	5500	
UHF9303-032-M04	1	3	-	3		3.8	0.8~1.8	0.9~1.8	6	#11	7000	●SS038
UHF9303-053-M04				5								
UHF9304-243-M14				4	6							
UHF9304-253-M14	2	4	2.2	5	7	3.8	0.8~1.8	0.9~1.8	8	#11	6500	





### UHU9000 series

- 直驅式伺服馬達型平型上送鎖邊機  
Direct drive type mini servo motor flat bed top feed overlock
- 須對花、對格之或滑溜之布料之車縫作業  
Suitable for fabrics with slippage materials, pattern matching operation.
- 薄至中厚布料。  
Light to medium weight materials.

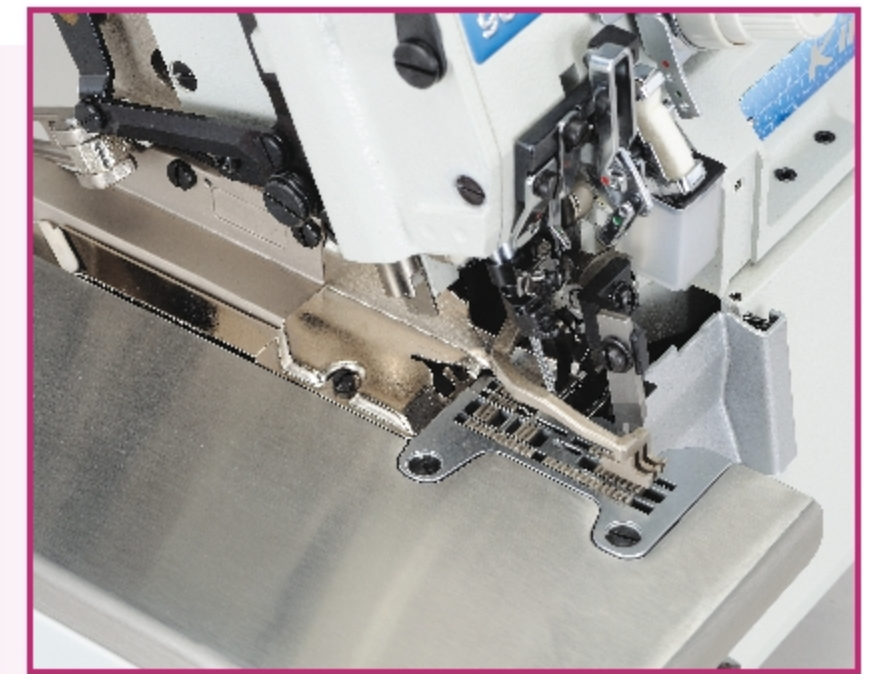

US040:側吸風式自動切線刀(水平吸風式)  
Side suction type thread trimmer (horizontal type).



### UHU9300 series

- 直驅式伺服馬達筒型上送鎖邊機  
Direct drive type mini servo motor cylinder bed top feed machine
- 須對花、對格之或滑溜之布料之車縫作業  
Suitable for fabrics with slippage materials, pattern matching operation.
- 薄至中厚布料。  
Light to medium weight materials.

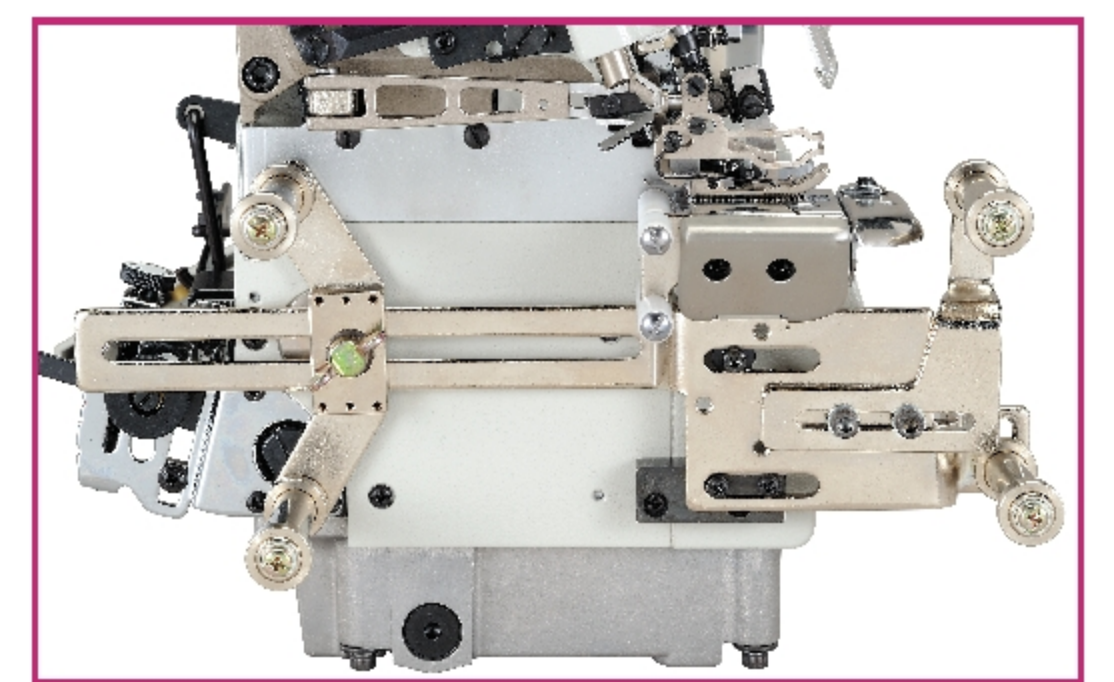

筒型衣物撐開滾輪組 (TR012)  
FABRIC TENSION CONTROLLING DEVICE  
可依衣物長短配合選用。TR012 適用範圍 500 ~ 800 mm。  
(TENSION ROLLER) Can be used for different lengths of garments Suitable length: 500 ~ 800 m.m.

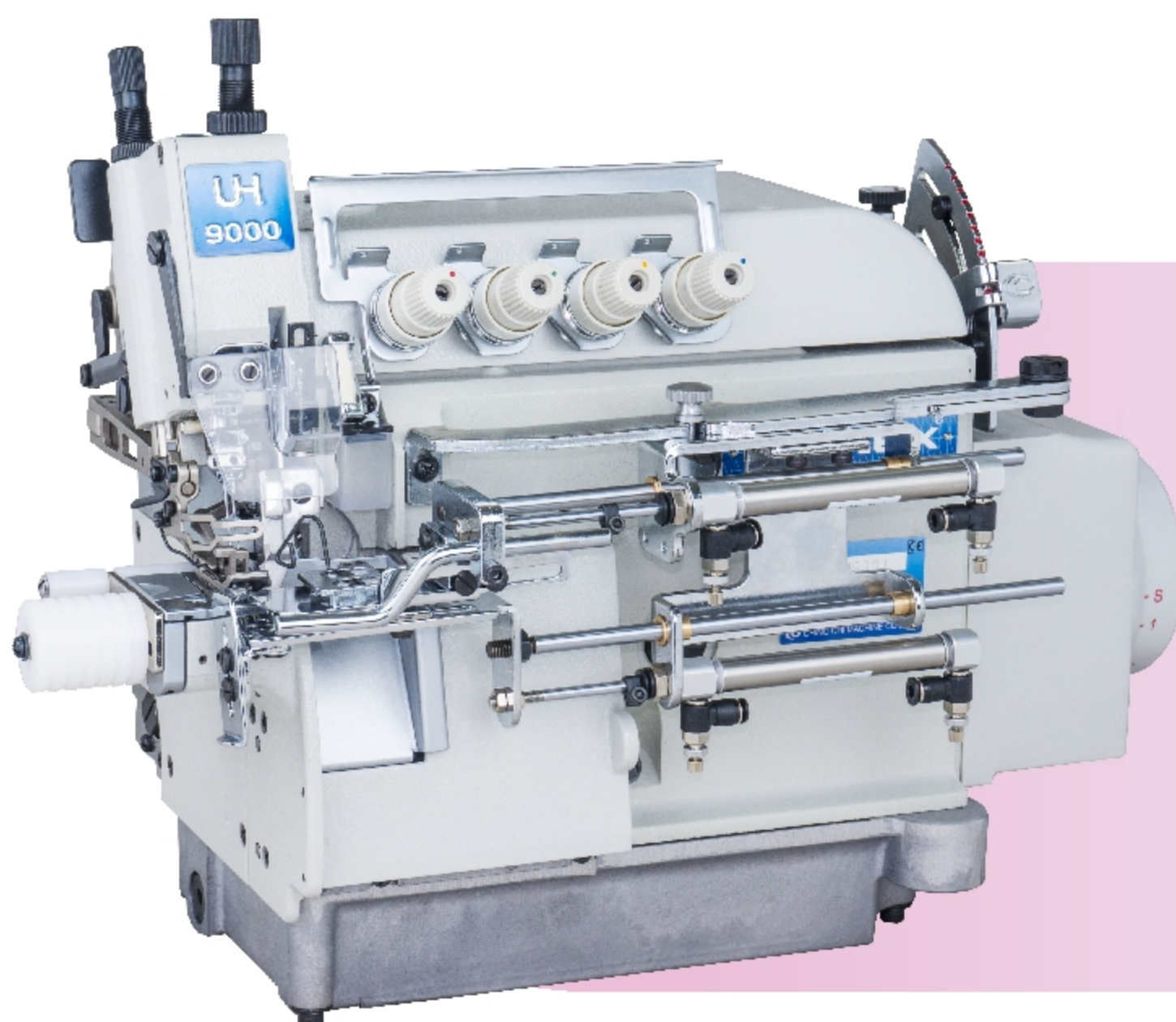

### UHU TR025

- 直驅自動側切筒型上送鎖邊機附羅紋領省工裝置  
Automatic chain cutter device direct-drive cylinder bed top feed overlock fitted with labor-saving rib folder.
- 氣動圓領衫縫製組  
Pneumatic circular collar device (TR025)
- 車縫恤的圓領，腰帶等編織製品的圓形羅紋鬆緊帶之用，只要將領條裝套在縫領機的導軌上，調節好前後鬆緊度及相應寬度，只需專注操控身片縫料，就能把羅紋的寬度車縫的均勻如一，提高縫領效能。  
Professional device for T-shirt collars, elastic belt stitch purpose, The device can help the operator to easier finish collar stitch without too much experience, But make products better quality and high efficiency.

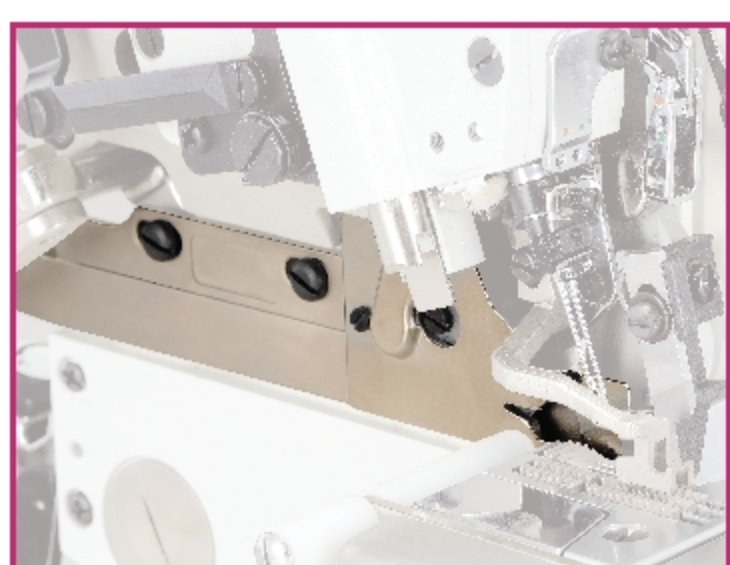

SS038:側吸風式自動切線刀(垂直吸風式)  
Side suction type thread trimmer (vertical type).

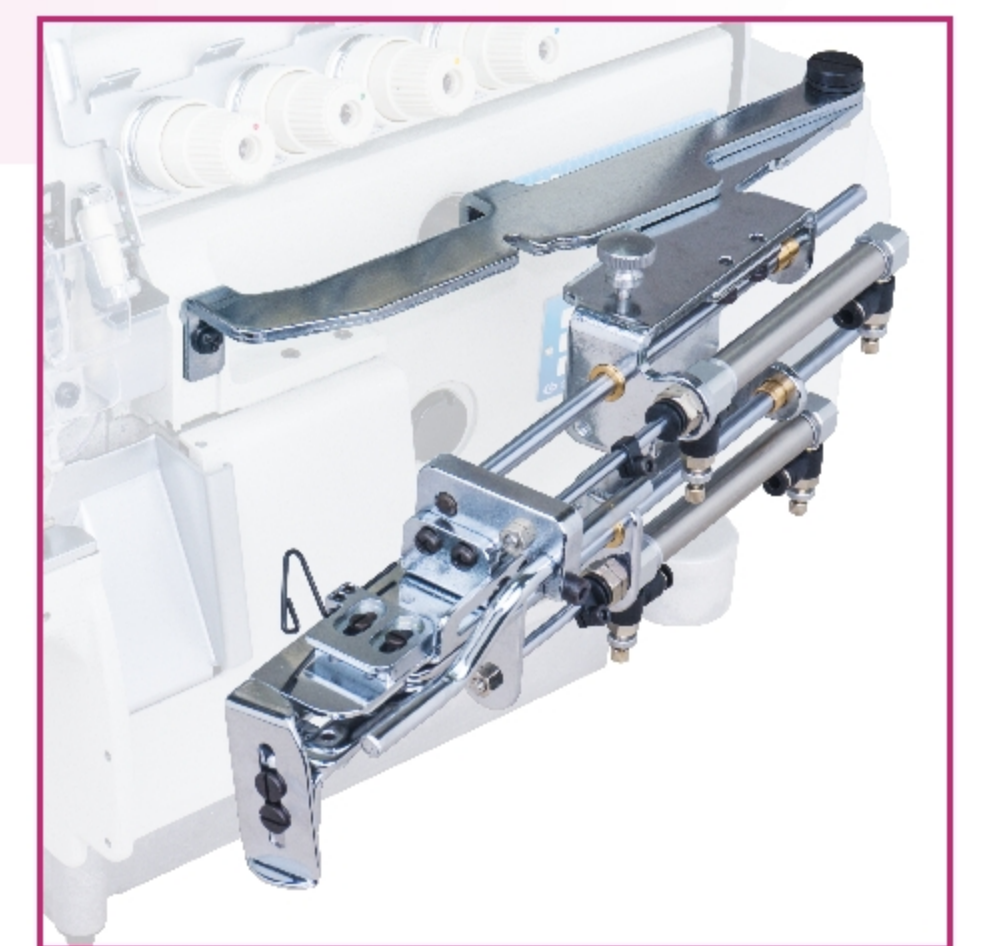
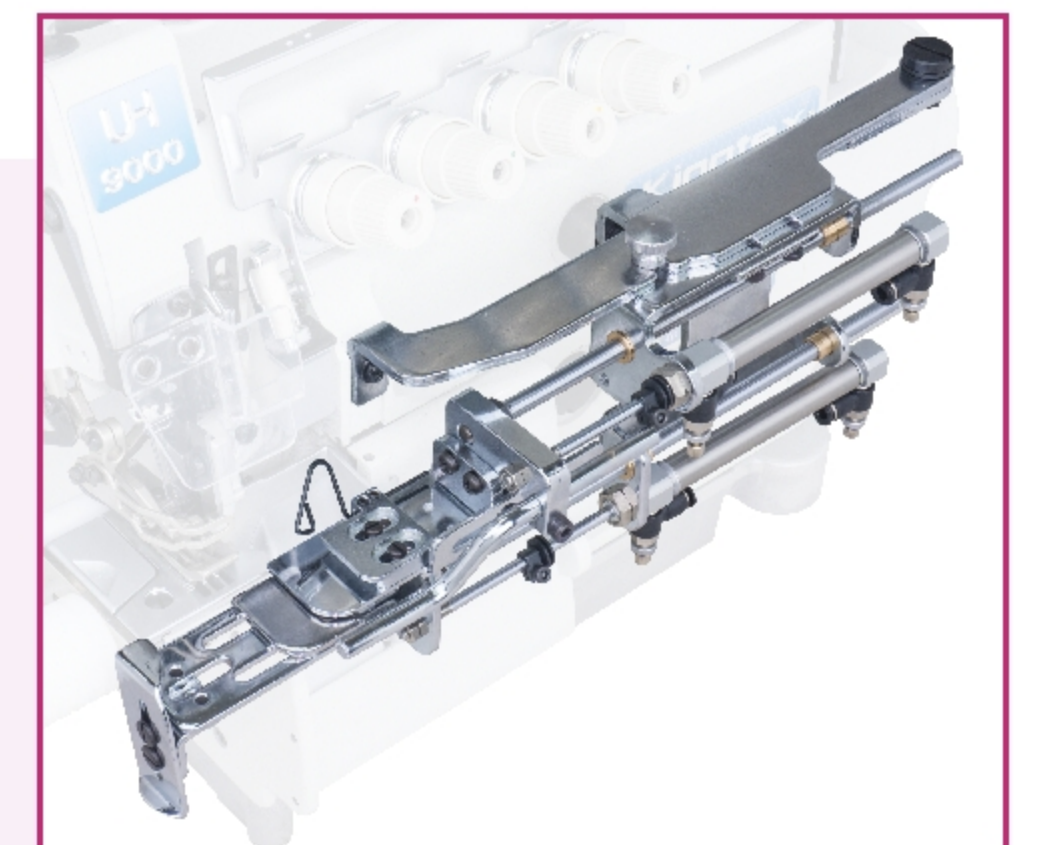

Icon	Icon	Icon	Icon	Icon	Icon	Icon	Icon	Icon	Icon	Icon	OPTIONAL DEVICE	
		m.m.	m.m.	max.m.m.			m.m.	DC x 27	S.P.M.			
UHU9004-243-M14			4	6								
UHU9004-253-M14	2	4	2.2	5	7	3.8	0.7~2	1~6	5.5	#11	6500	●SS037
UHU9004-253-H14				5	7							
UHU9004-263-M14				6	8							
UHU9005-353-M16			3	5	8	3.8	0.7~2					
UHU9005-553-M16	2	5	5	5	10	3.8	0.7~2	1~6	6	#11	6000	●US040
UHU9005-553-H16			5	5	10	4.5	0.6~1.6					
UHU9105-553-X16	2	5	5	5	10	4.5	0.6~1.6	1~7	8	#19	5500	
UHU9303-032-M04	1	3	-	3		3.8	0.8~1.8	0.5~6	6	#9	7000	
UHU9303-053-M04				4								●SS038
UHU9304-243-M14	2	4	2.2	4	6	3.8	0.8~1.8	0.5~6	8	#11	6500	
UHU9304-253-M14				5	7							
UHU9303-□□□-M04	1	3	-	□		3.8	0.8~1.8	0.5~6	6	#9	7000	●TR025
UHU9304-□□□-M14	2	4	2.2	□	□	3.8	0.8~1.8	0.5~6	8	#11	6500	



**UH** *Optional Device*

**TR012**

- 筒型衣物撐開滾輪組  
Fabric tensio controlling device (tensio roller)
- 可依衣物長短配合選用。  
適用範圍 500 ~ 800 mm。  
Can be used for different lengths of garments.  
Suitable length: 500 ~ 800 m.m.

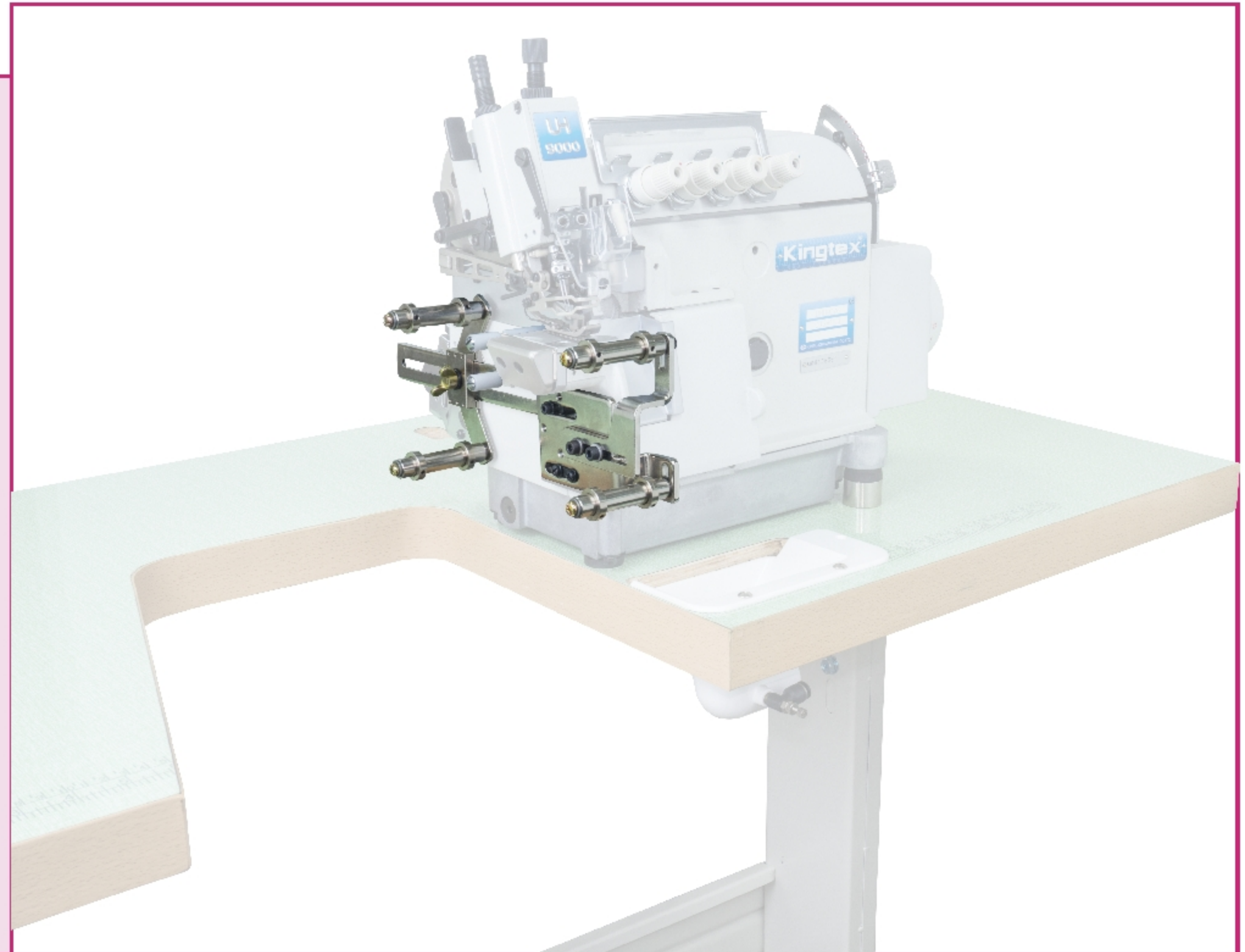

**UH** *Optional Device*

**TR023**

- 筒型衣物撐開滾輪組  
Fabric tensio controlling device (tensio roller)
- 可依衣物長短配合選用。  
適用範圍 300 ~ 800 mm。  
Can be used for different lengths of garments.  
Suitable length: 300 ~ 800 m.m.

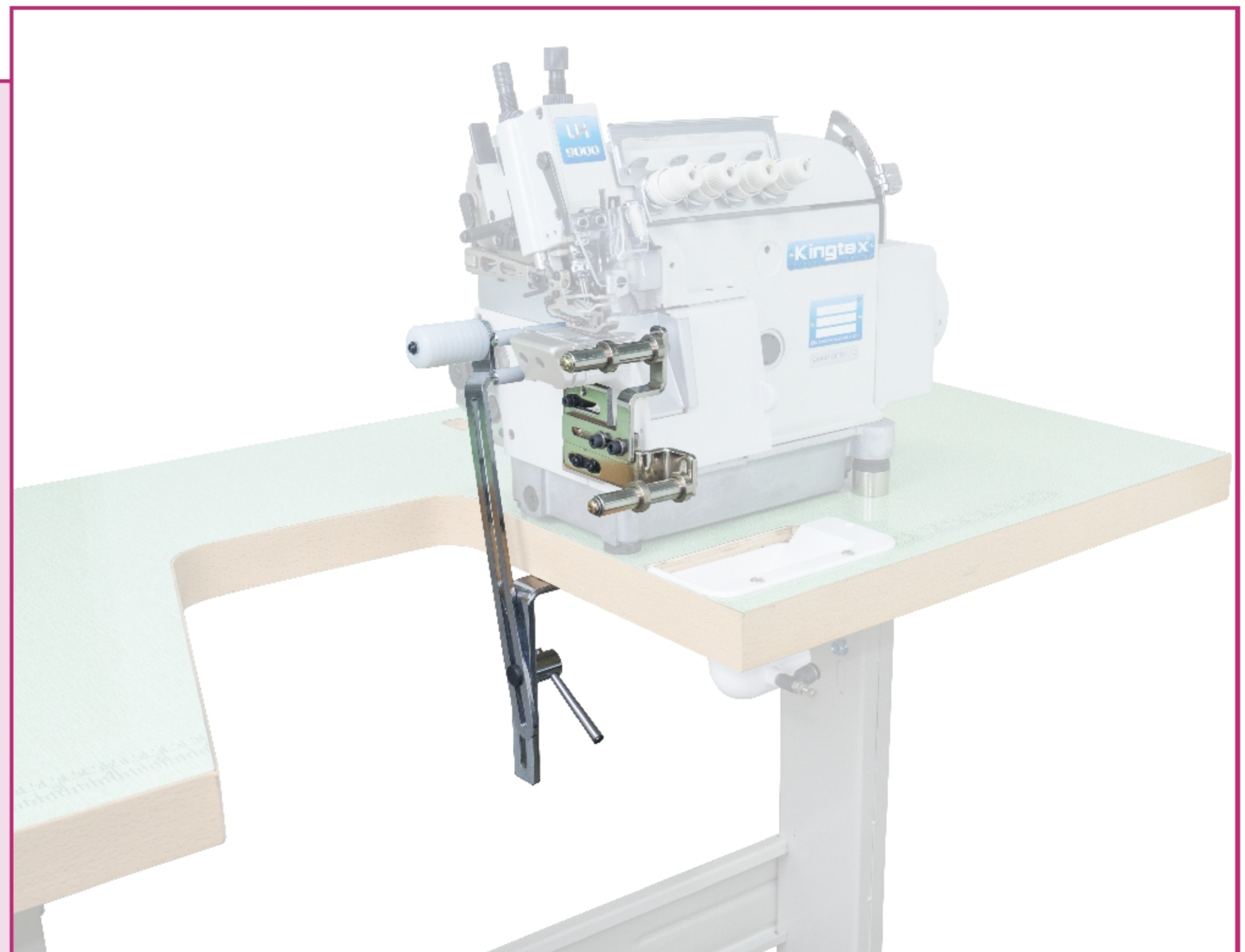

**UH** *Optional Device*

**TR027**

- 氣動圓領衫縫製組  
Pneumatic circular collar device
- 可依衣物長短配合選用。  
適用範圍 500 ~ 800 mm。  
Can be used for different lengths of garments.  
Suitable length: 500 ~ 800 m.m.

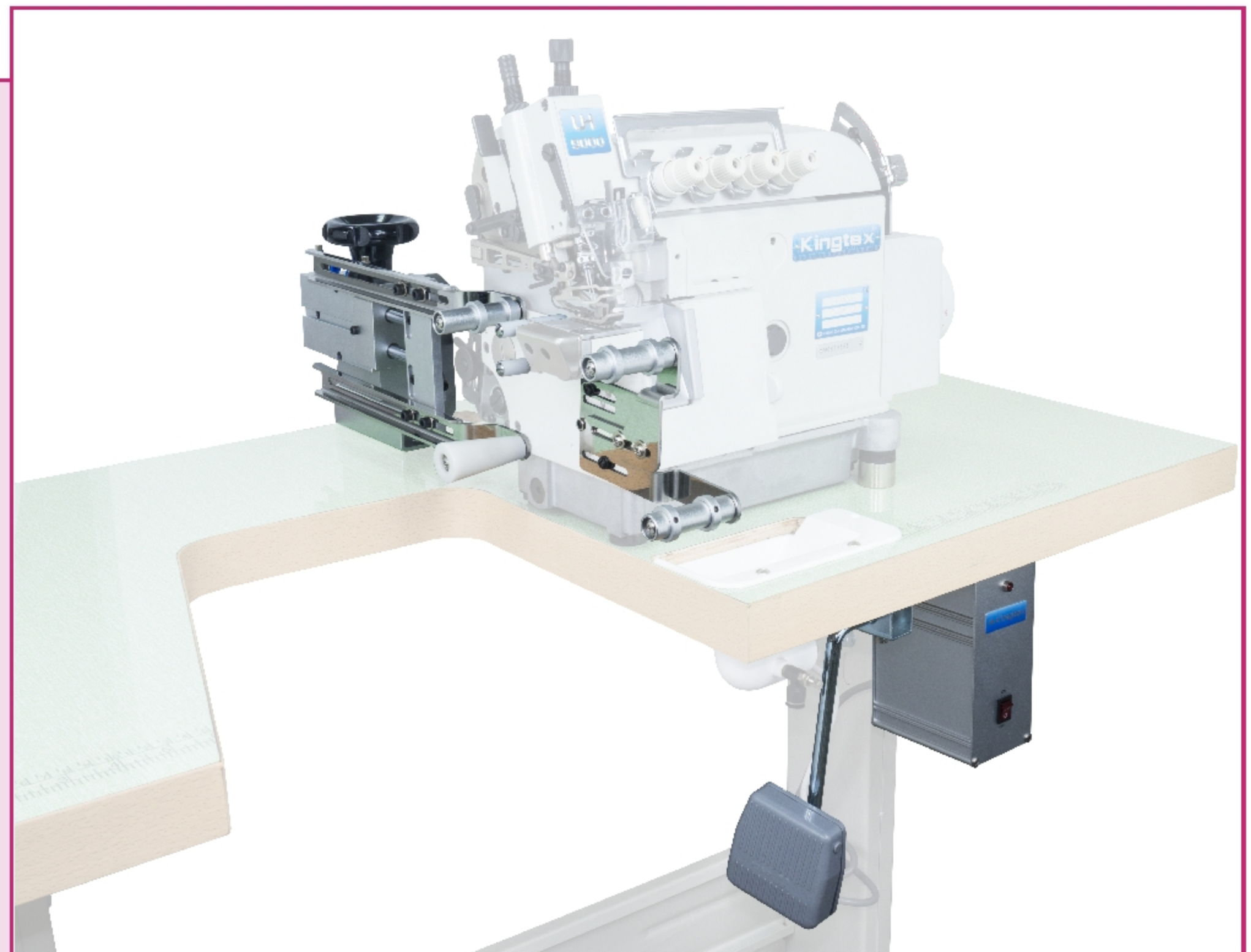



**UH** *Optional Device***TR011**

- 筒型衣物撐開滾輪組  
Fabric tensio controlling device (tensio roller)
- 可依衣物長短配合選用。  
適用範圍 800 ~ 1100 mm。  
Can be used for different lengths of garments.  
Suitable length: 800 ~ 1100 m.m.

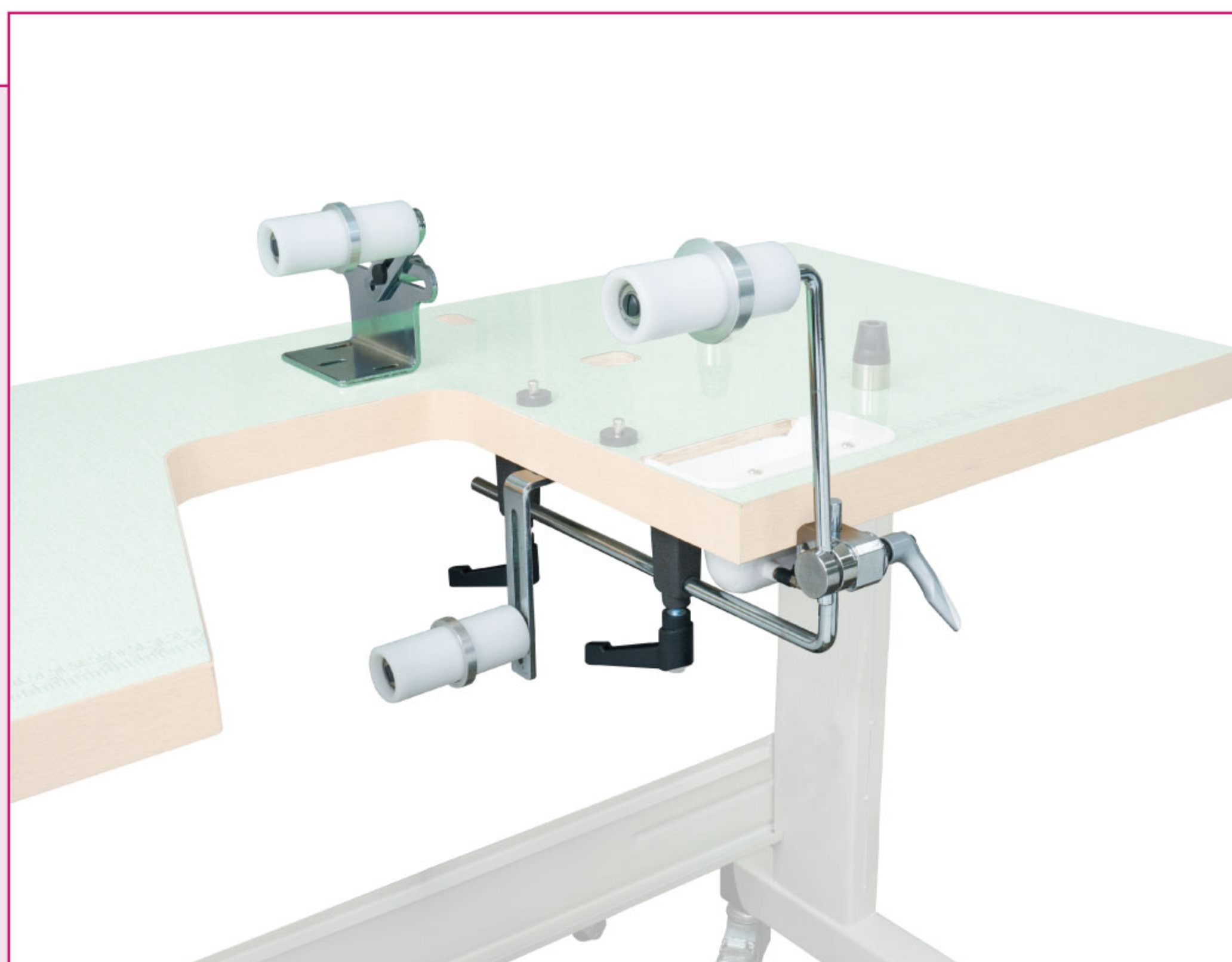
**UH** *Optional Device***TR017**

- 筒型衣物撐開滾輪組  
Fabric tensio controlling device (tensio roller)
- 可依衣物長短配合選用。  
適用範圍 800 ~ 1500 mm。  
Can be used for different lengths of garments.  
Suitable length: 800 ~ 1500 m.m.

**UH** *Optional Device***TR019**

- 筒型衣物撐開滾輪組  
Fabric tensio controlling device (tensio roller)
- 可依衣物長短配合選用。  
適用範圍 600 ~ 1500 mm。  
Can be used for different lengths of garments.  
Suitable length: 600 ~ 1500 m.m.





● 機型編號說明  
● MODEL NUMBERING

**UHD50** □ □ **F-** □ □ □ - **M14** / **UTC**

1 2 3 4 5 6 7 8 9

用途代號 /  
Application Code:  
0:基本型  
Basic Model

針縫線數 /  
Number Of Thread:  
3:3線(3-Thread)  
4:4線(4-Thread)  
5:5線(5-Thread)  
6:6線(6-Thread)

機型 / Machine Type:  
UHD5000F:一體式直驅超高速包縫機  
Mechatronics Direct Drive  
Ultra High Speed Overlock  
Machine

針距代號 /  
Needle Distance:  
0:0.  
2:2.2m.m.  
3:3.2m.m.  
5:4.8m.m.

針縫邊寬 /  
Seam Width:  
3:3.0m.m.  
4:4.0m.m.  
5:5.0m.m.

線跡代號 /  
Stitching Code:  
04:#504  
14:#514  
16:#516  
44:#544

布料厚度 /  
Fabrics Thickness:  
M:中厚類  
Medium to Heavy

可選擇加裝之裝置 / Optional Device:  
UTC:氣動式下吸  
Pneumatic Type Flat Suction  
UTD:電動式下吸  
Electric Type Flat Suction  
KSC:氣動式側吸  
Pneumatic Type Side Suction

送布齒列數 /  
Rows Of Feed-Dogs:  
2:2列(Rows)  
3:3列(Rows)

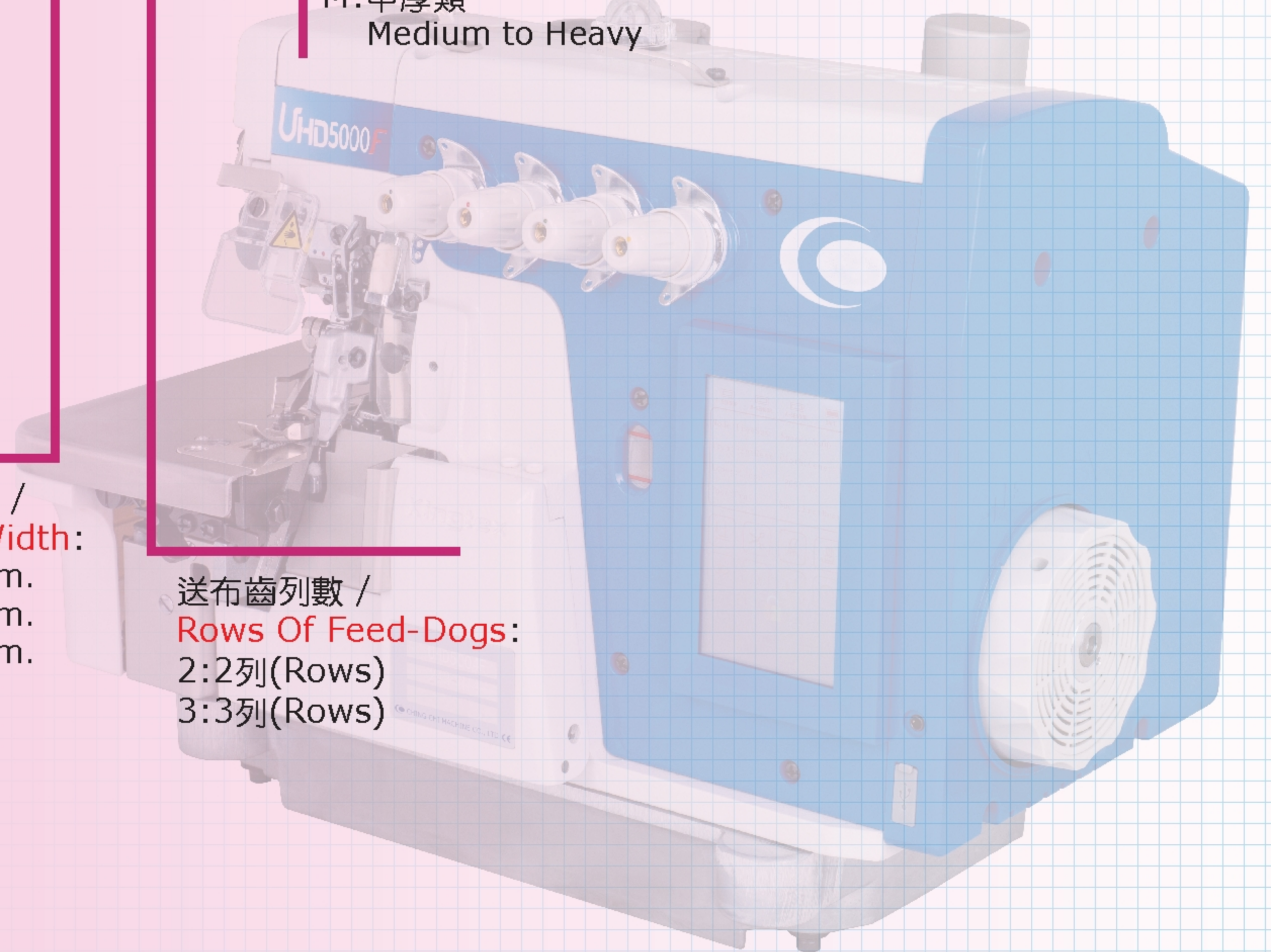

● 一般特性  
● GENERAL FEATURES



- 防偽LOGO  
With anti-fake KINGTEX Logo.
- 觸控螢幕，方便美觀好用。  
Touch panel design beautiful and easy to use.
- 新型三電眼接收器，整合電眼，剪線，LED，有效布邊檢測，節省馬達能源。  
New three electric eye receivers, integrated electric eyes, thread trimming, LED light, effective edge detection, saving motor electricity.

- 加大空間方便車縫，壓腳機構提高至 28mm，送料順暢。  
Larger feeding space, presser foot height increased to 28mm, ensures larger feeding space.
- 針杆，滑杆鍍DLC處理，增強表面耐磨性，有效防止少油情況機器卡死現象。  
DLC needle bar and DLC slider, improved worn-out resistance, preventing seize-up problem from happening, due to insufficient oil supply.
- 可調斬刀角度，任意縫線輕鬆切斷，線頭整齊美觀。  
Adjustable cutting angles, easy to cut any threads, thread end neat and beautiful.

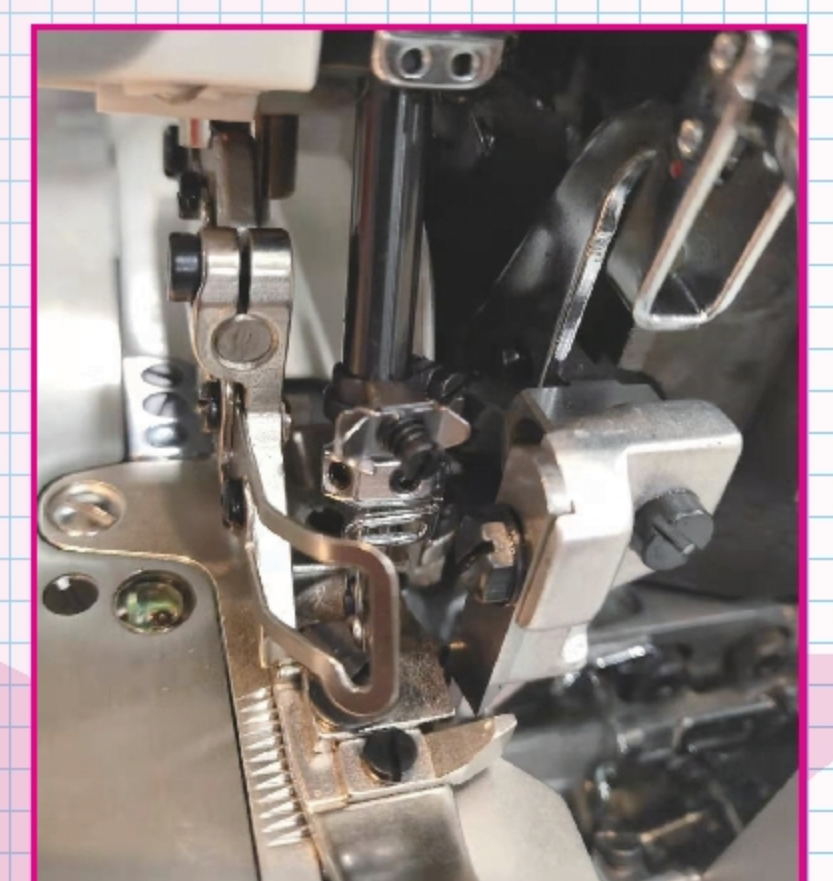
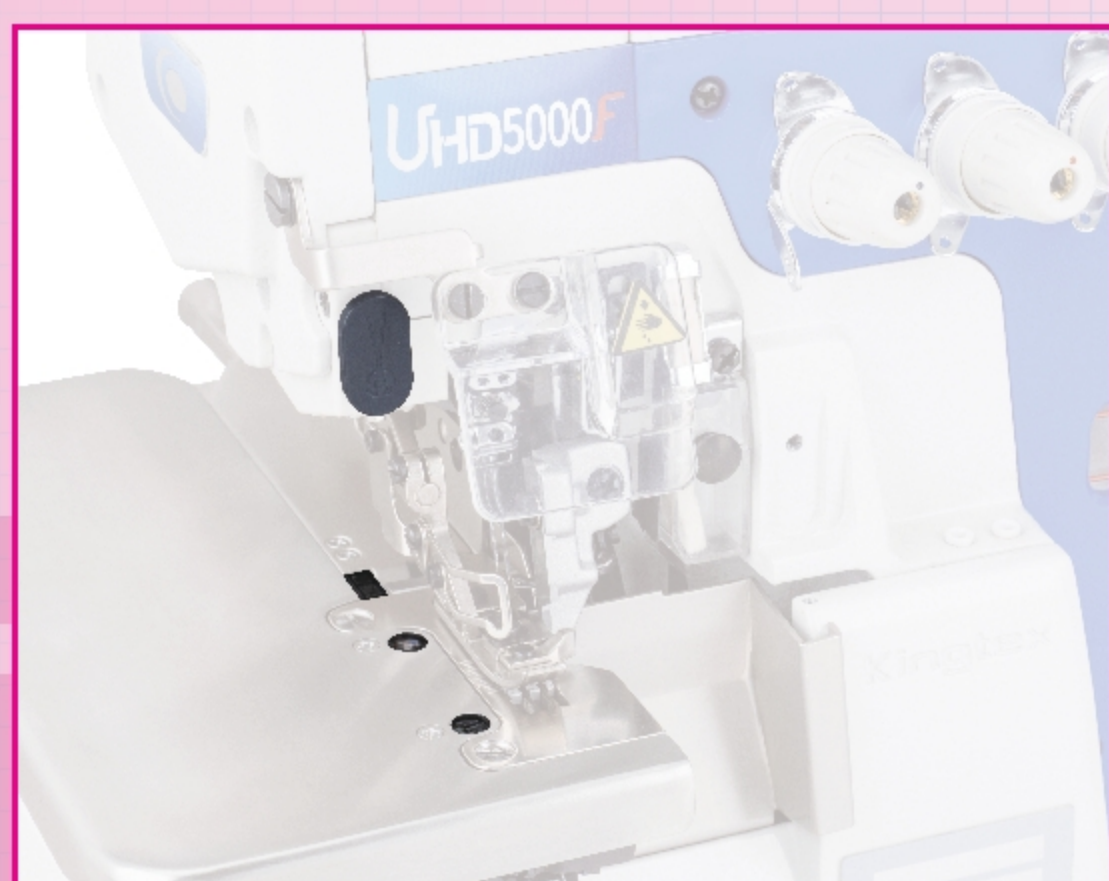



### UHD 5003F

- 一般包縫 (1針2線及1針3線包縫機)  
General Plain Seaming  
(1-Needle, 2-Thread & 1-Needle, 3-Thread Overlock)
- 一般薄至中厚布料，拷邊或接合用；可用於針織布，梭織布，斜紋布。  
For general plain seaming on light to medium weight materials. Knit wear, woven wear.

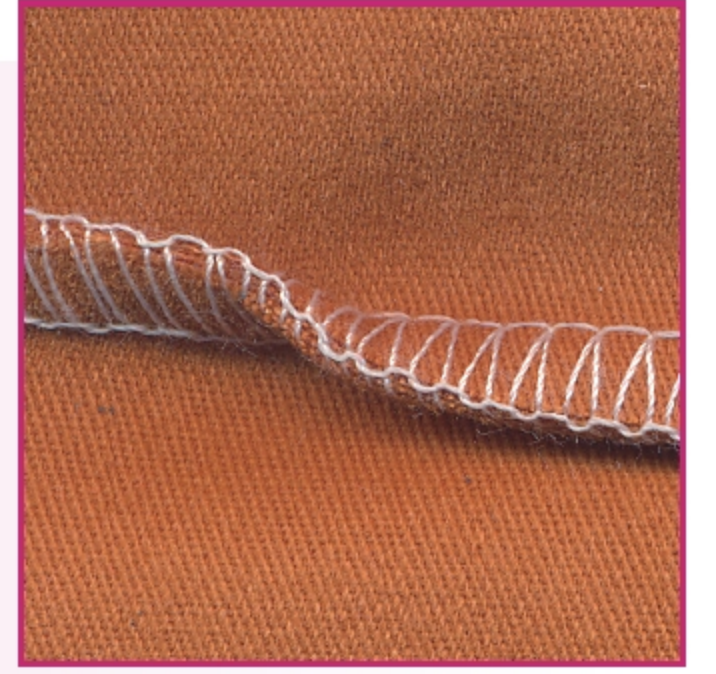

### UHD 5004F

- 一般包縫 (2針4線包縫機)  
General Plain Seaming  
(2-Needle, 4-Thread Overlock)
- 一般薄至中厚布料，拷邊或接合用；可用於針織布，泳衣布等。  
For general plain seaming on light to medium weight materials: Knit wear, swimming wear.

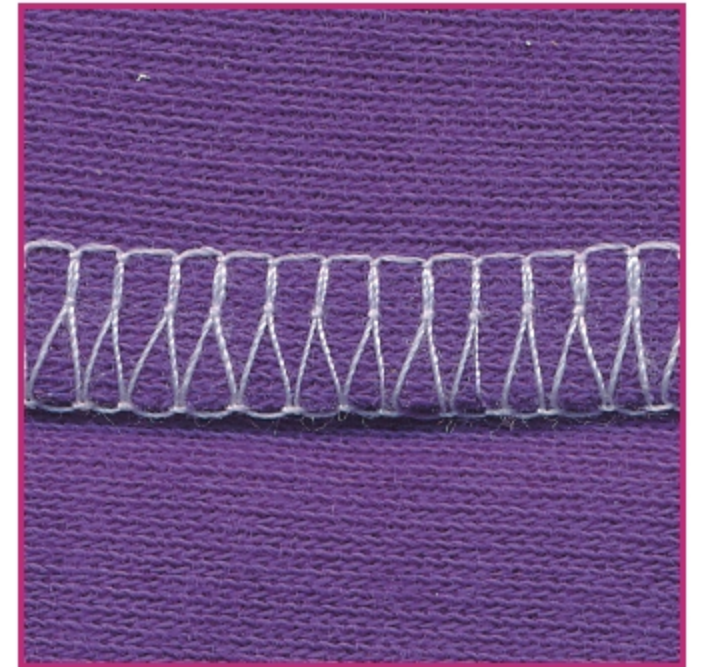





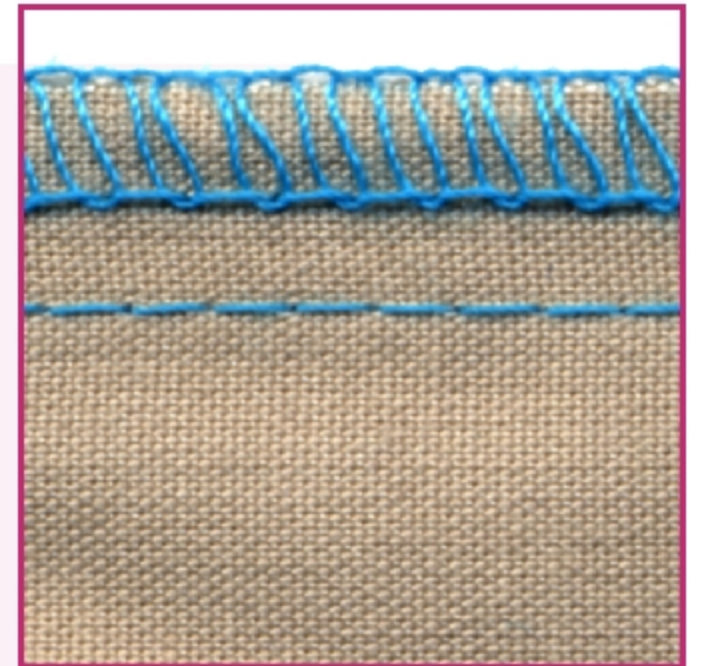





### UHD 5005F

- 一般包縫 (2針5線安全縫包縫機)  
General Plain Seaming  
(2-Needle, 5-Thread Safety Stitch Overlock)
- 一般薄至稍厚布料，安全縫作業；一般梭織布，襯衫，西褲等。  
For general safety stitch operation on medium to heavy weight materials.  
Woven shirts, trousers etc.



### UHD 5006F

- 三針六線萬用型包縫機  
3-Needle, 6-Thread Multi-Use Overlock Machine
- 薄至中厚布料。  
Light to medium weight materials.

			 m.m.	 m.m.	 max.m.m.		 m.m.	 DC x 27	 S.P.M.	OPTIONAL DEVICE
UHD5003F-032-M04	1	3	-	3	3.8	0.7~2	6	#11	6000	UTC UTD KSC
UHD5003F-053-M04				5				#14		
UHD5004F-243-M14	2	4	2.2	4	3.8	0.7~2	5.5	#11	6000	UTC UTD KSC
UHD5004F-253-M14				6						
UHD5005F-353-M16	2	5	3	5	3.8	0.7~2	6	#11	6000	UTC UTD
UHD5005F-553-M16			5	5						
UHD5006F-3243-M44	3	6	3 x 2.2	4	3.8	0.7~2	5	#11	6000	UTC UTD
UHD5006F-5243-M44			5 x 2.2	7						